



 **NANO MED**  
SURGICAL INSTRUMENTS



**NANO MED SURGICAL  
INSTRUMENTS**  
[www.krnano.com](http://www.krnano.com)

 **주식회사 나노메드**  
**NANO MED CO., LTD**

## CONVERSIONS

Inches to centimeters  
 $cm = in \times 2.54$

Centimeters to Inches  
 $in = cm \times 0.3937$

Millimeters to Inches  
 $in = mm \times 0.03937$

Inches		Millimeters	
1/8	1/16	→	1.588
	3/16	→	3.175
1/4	5/16	→	4.736
	3/8	→	6.350
3/8	7/16	→	7.938
	1/2	→	9.525
5/8	9/16	→	11.113
	5/8	→	12.700
3/4	11/16	→	14.288
	7/8	→	15.875
1	13/16	→	17.463
	15/16	→	19.050
		→	20.638
		→	22.225
		→	23.813
		→	25.400

**FRACTIONAL**

***Instruments Angles***

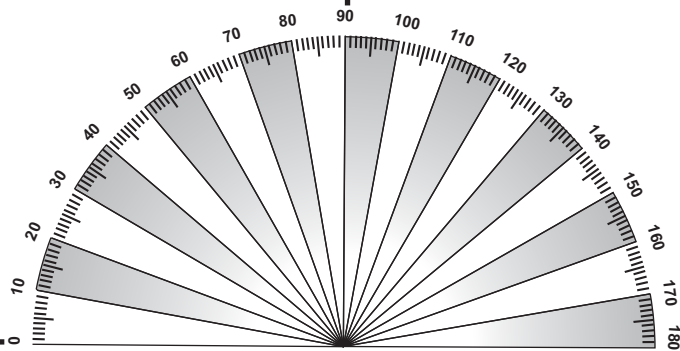

[www.krnano.com](http://www.krnano.com)

메스홀더/타진기/후두경

**SCALPEL HANDLES &  
DIAGNOSTIC INSTRUMENTS**

Page 003 - 010

## 재사용 의료기구의 관리

수술용 기구를 사용한 후 관리는 다음 순서에 의거 취급합니다.

### 사용된 의료기구의 관리

- (1) 사용된 의료기구는 흐르는 물에 솔이나 스펀지를 사용하여 씻습니다.
- (2) 1차 세척된 의료기구는 맨눈으로 깨진 곳은 없는지 변형된 곳은 없는지 검사를 하고 변형이 온 것은 분류 보관합니다.
- (3) 분류가 완료되면 이상이 없는 제품은 아래 순서에 의거 세척을 진행합니다.

### 세척

납품업체로부터 구매한 모든 의료기구는 세척 과정을 거쳐야 합니다. 사용된 의료기 또한 세척 과정을 거쳐야 합니다.

### 초음파 세척기가 있는 세척방법

1. 초음파 세척기에 규격에 맞는 물을 채우고 중성세제를 투입합니다. 이때 과탄산소다를 첨가하면 스테인리스에 검은 변색을 막을 수 있습니다.
2. 바스켓에 의료기구를 담아 초음파 세척기 넣습니다. (10분 이상 작동합니다.)
3. 초음파 세척이 완료된 의료기구는 흐르는 수돗물에 세제를 제거합니다.
4. 물기를 제거한 의료기구는 각 병원의 매뉴얼에 따라 소독을 시행합니다.

### 초음파 세척기가 없는 세척방법

1. 1차 세척과 분류작업이 완성된 의료기구를 큰 통에 넣고 물을 채웁니다.
2. 중성세제와 과탄산소다를 넣고 15분 정도 불림을 실시합니다.
3. 솔과 스펀지를 이용하여 이물질 제거합니다.
4. 세척이 완료된 의료기구는 흐르는 수돗물에 세제 제거합니다.
4. 물기를 제거한 의료기구는 각 병원의 매뉴얼에 따 소독을 시행합니다.



우리 회사 의료기구는 KGMP 규정에 의거 철저한 품질관리로 생산된 제품입니다. 상기 방법대로 관리를 하신다면 수술기구 교체 비용을 최소화될 것입니다



1/1

Standard  
01-001-03  
No. 3



1/1

01-002-04  
No. 4



1/1

01-003-05  
No. 3 Graduated



1/1

01-004-31  
No. 3L

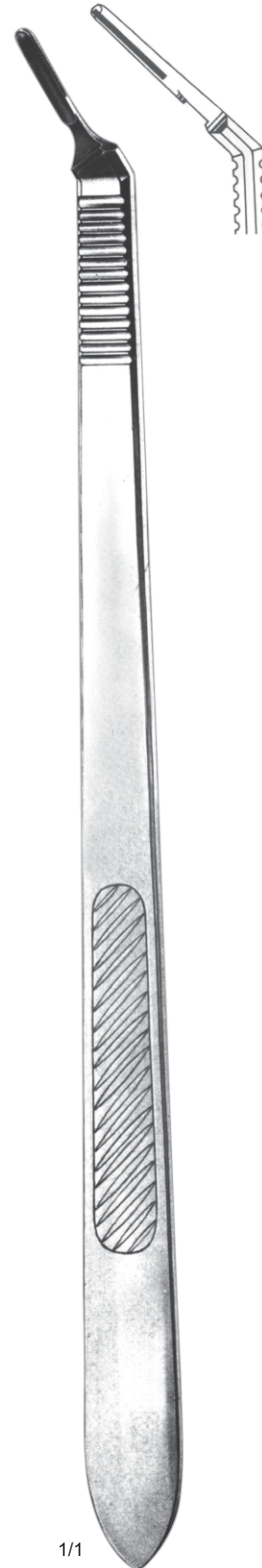

1/1

01-005-35  
No. 3L cvd



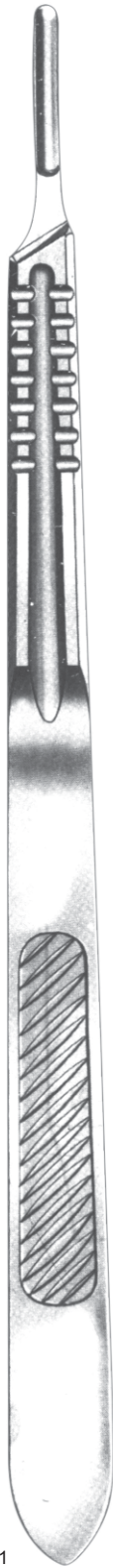

1/1  
01-006-41  
No. 4L

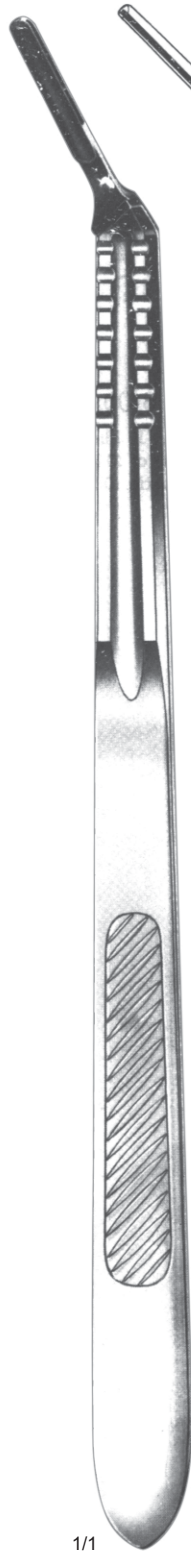

1/1  
01-007-45  
No. 4L cvd

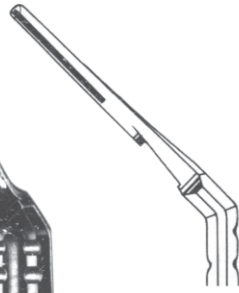

1/1  
01-008-07  
No. 7



1/1  
01-009-71  
No. 7K



1/1  
01-010-03  
No. 3 Round



1/1  
01-011-03  
No. 3 Round cvd



Taylor  
01-012-20  
20 cm / 8"



Buck  
01-013-18  
18 cm / 7"

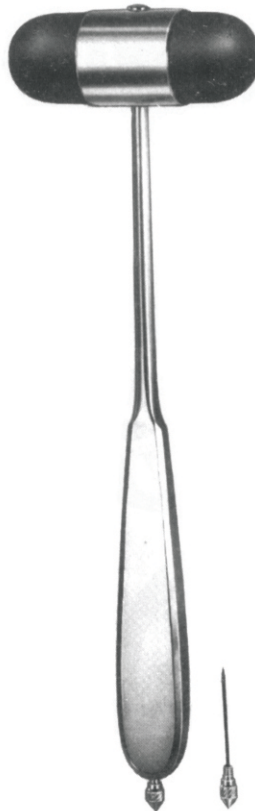

Déjerine  
01-014-21  
21 cm / 8¼"

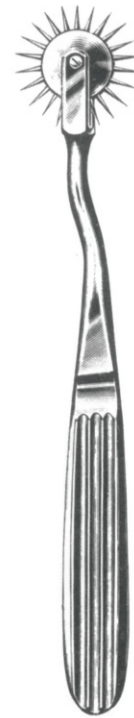

Wartenberg  
01-015-19  
19 cm / 7½"





Dissecting Set of 9 pieces  
01-016-00





Miller Set  
01-017-00  
Regular

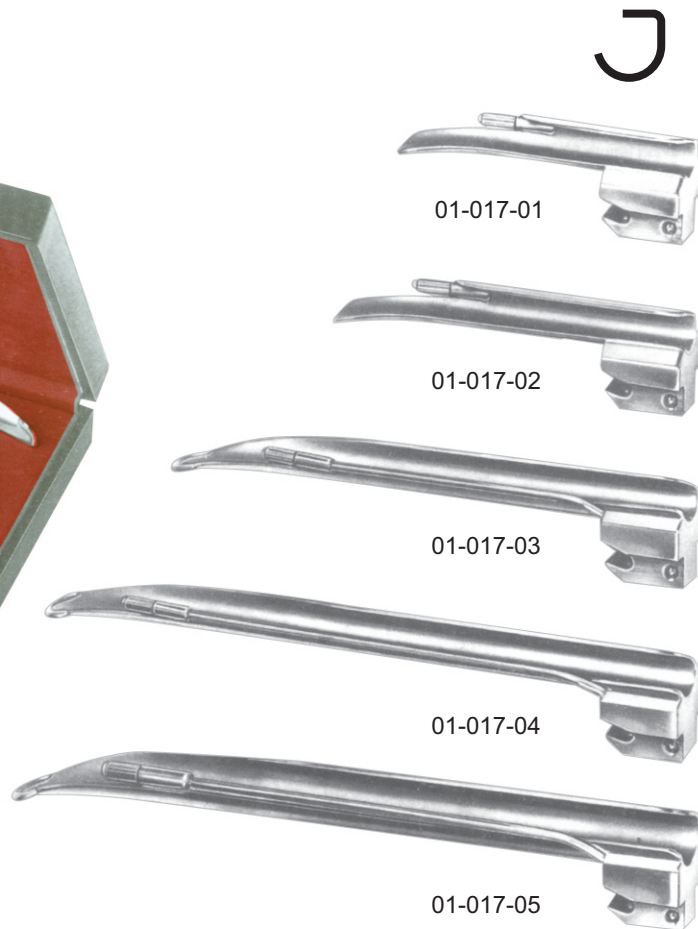

01-017-01

01-017-02

01-017-03

01-017-04

01-017-05

**SPARE BLADES**



Miller Set  
01-018-00  
Fiber Optic

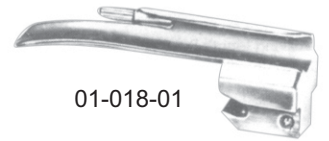

01-018-01



01-018-02



01-018-03



01-018-04



01-018-05



**SPARE BLADES**



McIntosh Set  
01-019-00  
Regular

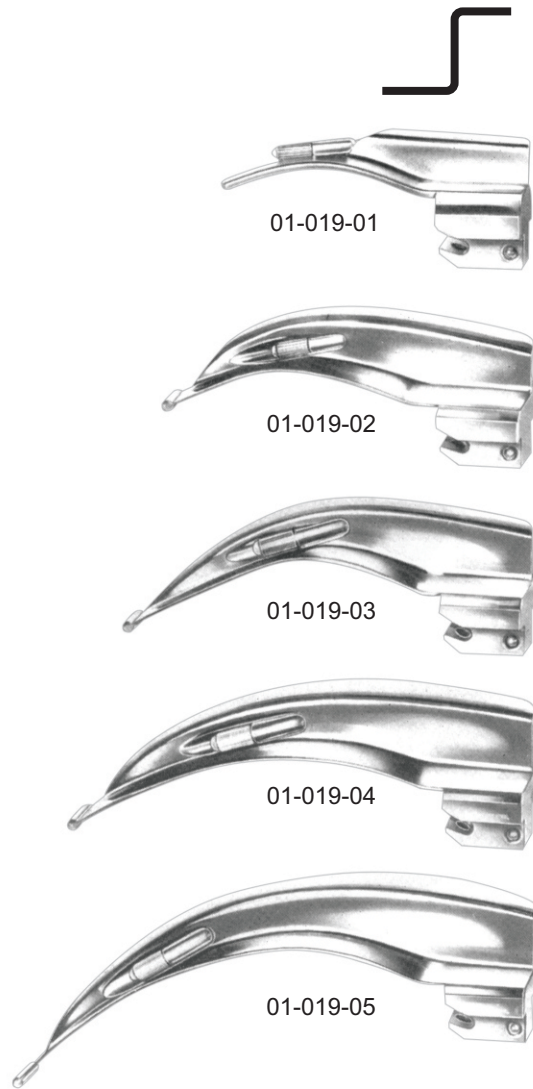

**SPARE BLADES**





McIntosh Set  
01-020-00  
Fiber Optic

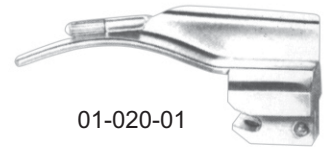

01-020-01



01-020-02



01-020-03



01-020-04



01-020-05

**SPARE BLADES**



[www.krnano.com](http://www.krnano.com)

의료용 가위

**SCISSORS**

Page 013 - 046



#### 일반 스테인리스 가위:

일반 가위는 가장 적합한 스테인리스 420 재질로 제작됩니다.  
강철이며 수명이 제한되어 있습니다.

#### 텅스텐 카바이드(TC) 가위:

TC 가위는 외과 의사가 가장 많이 사용하는 가위입니다.  
그리고 세계의 일반 진료소. TC 소재는  
경도와 내구성이 좋습니다.  
NANO MED의 TC 제품은 텅스텐 카바이드는 최상의  
원자재를 이용하여 제작됩니다.  
텅스텐 카바이드(TC) 가위의 손잡이는 24K 순금으로 도금되어 있으며  
이것은 텅스텐 카바이드(TC)로 제작되었다는 표시입니다.

#### 슈퍼 컷(SC) 가위:

최근 선보인 가위 중 가장 정교한 가위입니다.  
두 개의 서로 다른 칼날로, 하나의 칼날에는 미세 톱니가 있고.  
두 번째 칼날은 매우 날카로운 칼날 이뤄져 있습니다.  
이 가위는 일반적으로 미세한 절삭력을 요구될 때 사용할 수 있습니다

#### 텅스텐 카바이드 슈퍼 컷 (TCSC) 가위:

NANO MED는 이 독특한 가위를 자랑스럽게 제공합니다.  
완벽한 절삭력과 내구성, TC SC만이 가능한 능력

맞춤형 주문으로 공급됩니다.





1/1

02-001-10  
10.5 cm / 4 1/4"

02-001-11  
11.5 cm / 4 1/2"

02-001-13  
13 cm / 5"

02-001-14  
14.5 cm / 5 1/2"

02-001-15  
15.5 cm / 6"

02-001-16  
16.5 cm / 6 1/2"

Standard / Op. Scissor (Str.)  
02-001-10 - 02-001-16

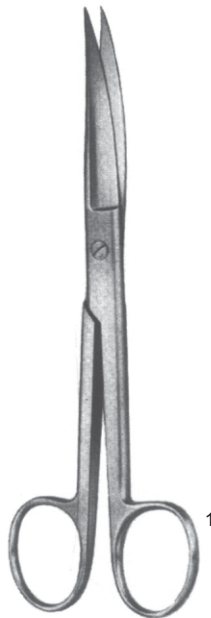

1/1

02-002-11  
11.5 cm / 4 1/4"

02-002-13  
13.5 cm / 5"

02-002-14  
14.5 cm / 5 1/2"

02-002-15  
15.5 cm / 6"

02-002-16  
16.5 cm / 6 1/2"

Standard / Op. Scissor (Cvd.)  
02-002-11 - 02-002-16



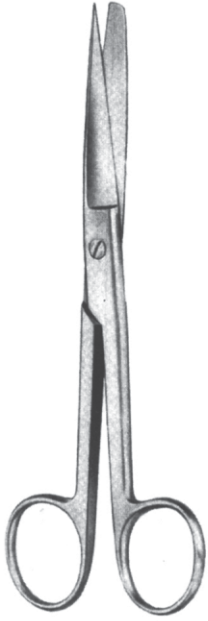

1/1

02-003-11  
11.5 cm / 4½"

02-003-13  
13 cm / 5"

02-003-14  
14.5 cm / 5½"

02-003-16  
16.5 cm / 6½"

02-003-18  
18.5 cm / 7½"

Standard / Op. Scissor (Str.)  
02-003-11 - 02-003-18

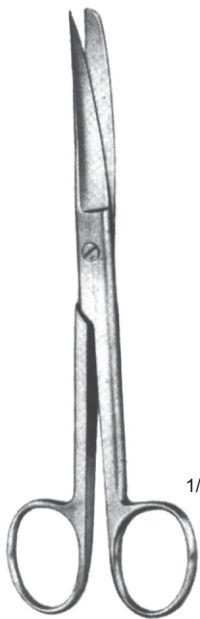

1/1

02-004-11  
11.5 cm / 4½"

02-004-13  
13 cm / 5"

02-004-14  
14.5 cm / 5½"

02-004-16  
16.5 cm / 6½"

02-004-18  
18.5 cm / 7½"

Standard / Op. Scissor (Cvd.)  
02-004-11 - 02-004-18



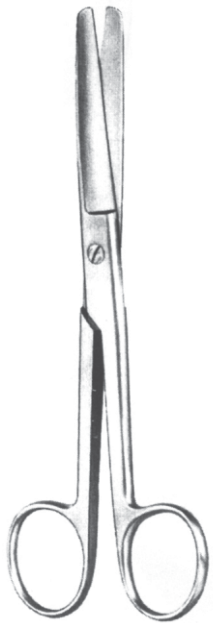

1/1

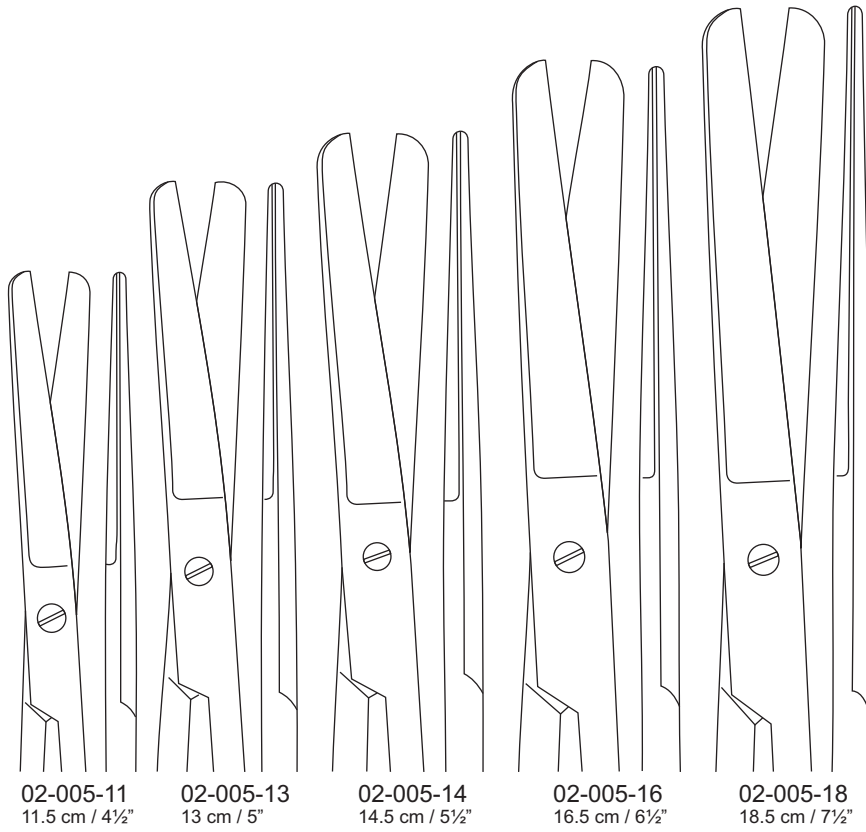

02-005-11  
11.5 cm / 4½"

02-005-13  
13 cm / 5"

02-005-14  
14.5 cm / 5½"

02-005-16  
16.5 cm / 6½"

02-005-18  
18.5 cm / 7½"

Standard / Op. Scissor (Str.)  
02-005-11 - 02-005-18

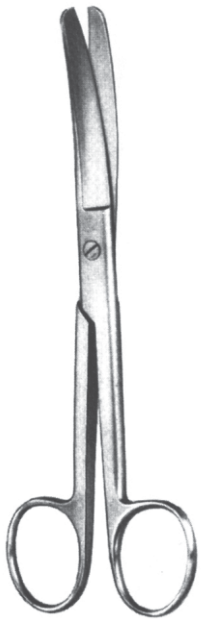

1/1

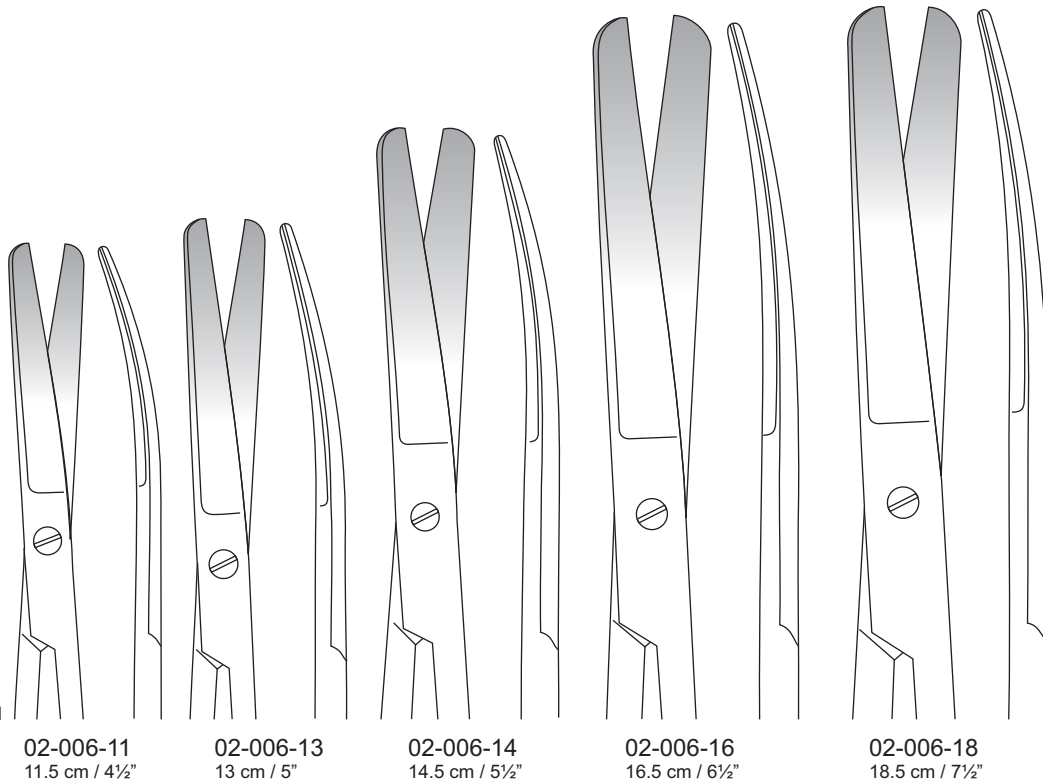

02-006-11  
11.5 cm / 4½"

02-006-13  
13 cm / 5"

02-006-14  
14.5 cm / 5½"

02-006-16  
16.5 cm / 6½"

02-006-18  
18.5 cm / 7½"

Standard / Op. Scissor (Cvd.)  
02-006-11 - 02-006-18



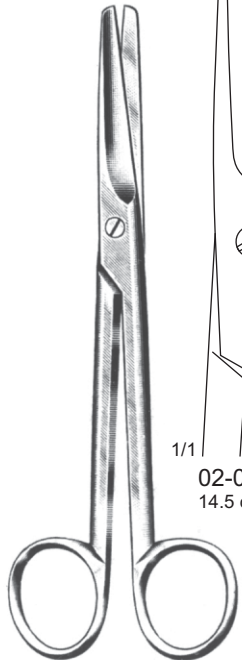

1/1

- 02-007-14  
14.5 cm / 5½"
- 02-007-15  
15 cm / 6"
- 02-007-17  
17 cm / 6¾"
- 02-007-23  
23 cm / 9"
- 02-008-14  
14.5 cm / 5½"
- 02-008-15  
15 cm / 6"
- 02-008-17  
17 cm / 6¾"
- 02-008-23  
23 cm / 9"

Mayo  
02-007-14 - 02-008-23

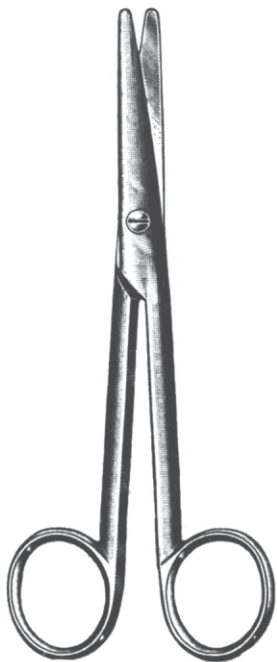

1/1

- 02-009-15  
15 cm / 6"
- 02-009-17  
17 cm / 6¾"
- 02-010-15  
15 cm / 6"
- 02-010-17  
17 cm / 6¾"

Mayo-Stillie  
02-009-15 - 02-010-17

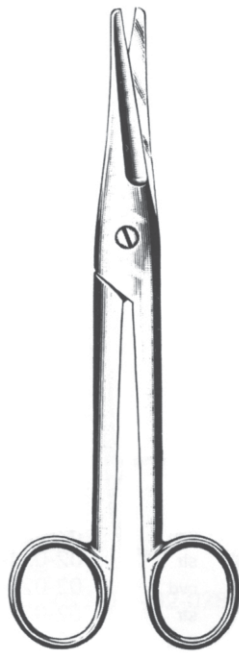

Mayo-Noble  
02-011-17 - 02-012-17  
17 cm / 6¾"

1/1



02-011-17

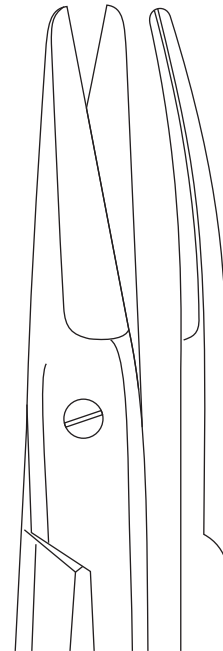

02-012-17

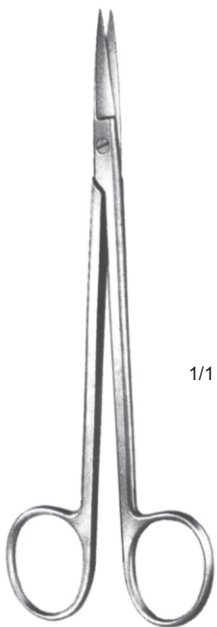

Kelly  
02-013-16 - 02-014-18

1/1



02-013-16  
16 cm / 6½"

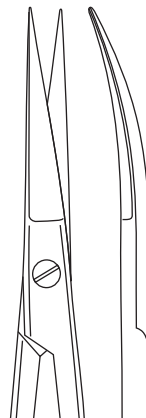

02-014-16  
16 cm / 6½"



Metzenbaum (Baby)  
02-015-11 - 02-016-11  
11.5 cm / 4½"

1/1



02-015-11

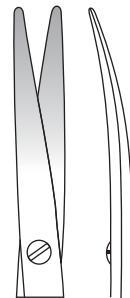

02-016-11



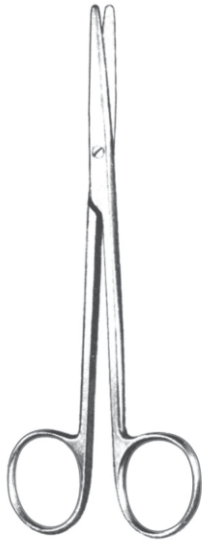

**Metzenbaum**  
02-017-14 - 02-022-14

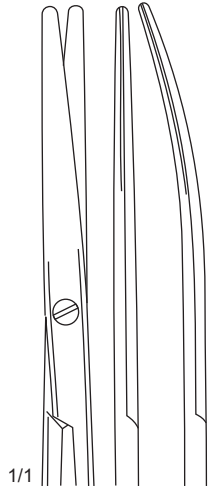

- 02-017-14 14 cm / 5½" str
- 02-018-14 14 cm / 5½" cvd
- 02-017-15 15 cm / 6" str
- 02-018-15 15 cm / 6" cvd
- 02-017-18 18 cm / 7" str
- 02-018-18 18 cm / 7" cvd
- 02-017-20 20 cm / 8" str
- 02-018-20 20 cm / 8" cvd
- 02-017-23 23 cm / 9" str
- 02-018-23 23 cm / 9" cvd
- 02-017-25 25 cm / 10" str
- 02-018-25 25 cm / 10" cvd
- 02-017-28 28 cm / 11" str
- 02-018-28 28 cm / 11" cvd
- 02-017-30 30 cm / 12" str
- 02-018-30 30 cm / 12" cvd

**B/B**

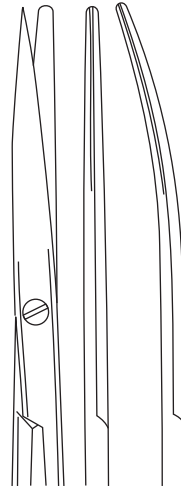

- 02-019-14 14 cm / 5½" str
- 02-020-14 14 cm / 5½" cvd
- 02-019-15 15 cm / 6" str
- 02-020-15 15 cm / 6" cvd
- 02-019-18 18 cm / 7" str
- 02-020-18 18 cm / 7" cvd
- 02-019-20 20 cm / 8" str
- 02-020-20 20 cm / 8" cvd
- 02-019-23 23 cm / 9" str
- 02-020-23 23 cm / 9" cvd
- 02-019-25 25 cm / 10" str
- 02-020-25 25 cm / 10" cvd
- 02-019-28 28 cm / 11" str
- 02-020-28 28 cm / 11" cvd
- 02-019-30 30 cm / 12" str
- 02-020-30 30 cm / 12" cvd

**S/B**

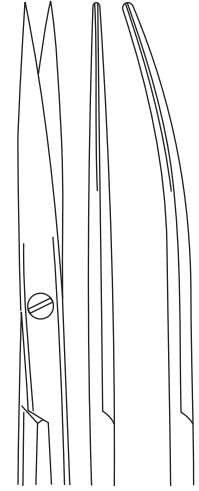

- 02-021-14 14 cm / 5½" str
- 02-022-14 14 cm / 5½" cvd
- 02-021-15 15 cm / 6" str
- 02-022-15 15 cm / 6" cvd
- 02-021-18 18 cm / 7" str
- 02-022-18 18 cm / 7" cvd
- 02-021-20 20 cm / 8" str
- 02-022-20 20 cm / 8" cvd
- 02-021-23 23 cm / 9" str
- 02-022-23 23 cm / 9" cvd
- 02-021-25 25 cm / 10" str
- 02-022-25 25 cm / 10" cvd
- 02-021-28 28 cm / 11" str
- 02-022-28 28 cm / 11" cvd
- 02-021-30 30 cm / 12" str
- 02-022-30 30 cm / 12" cvd

**S/S**

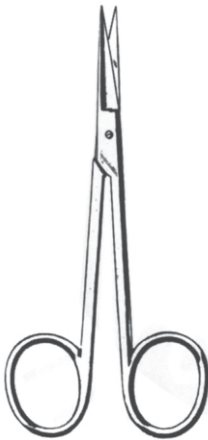

**Iris**  
02-023-11 - 02-026-11  
11.5 cm / 4½"

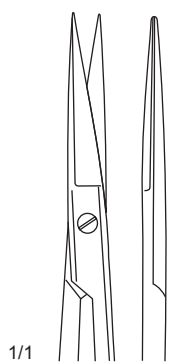

02-023-11

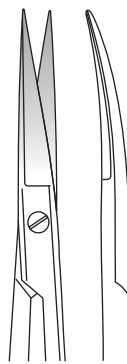

02-024-11

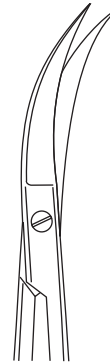

02-025-11

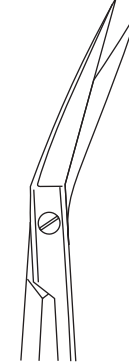

02-026-11



Iris  
02-027-09 - 02-028-10

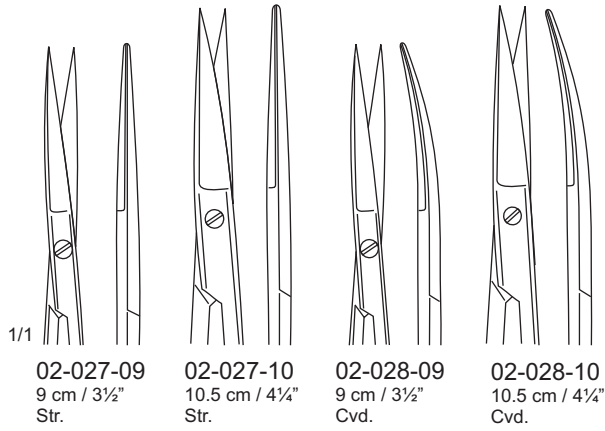

02-027-09  
9 cm / 3½"  
Str.

02-027-10  
10.5 cm / 4¼"  
Str.

02-028-09  
9 cm / 3½"  
Cvd.

02-028-10  
10.5 cm / 4¼"  
Cvd.



Stevens  
02-029-11 - 02-032-11  
11.5 cm / 4½"

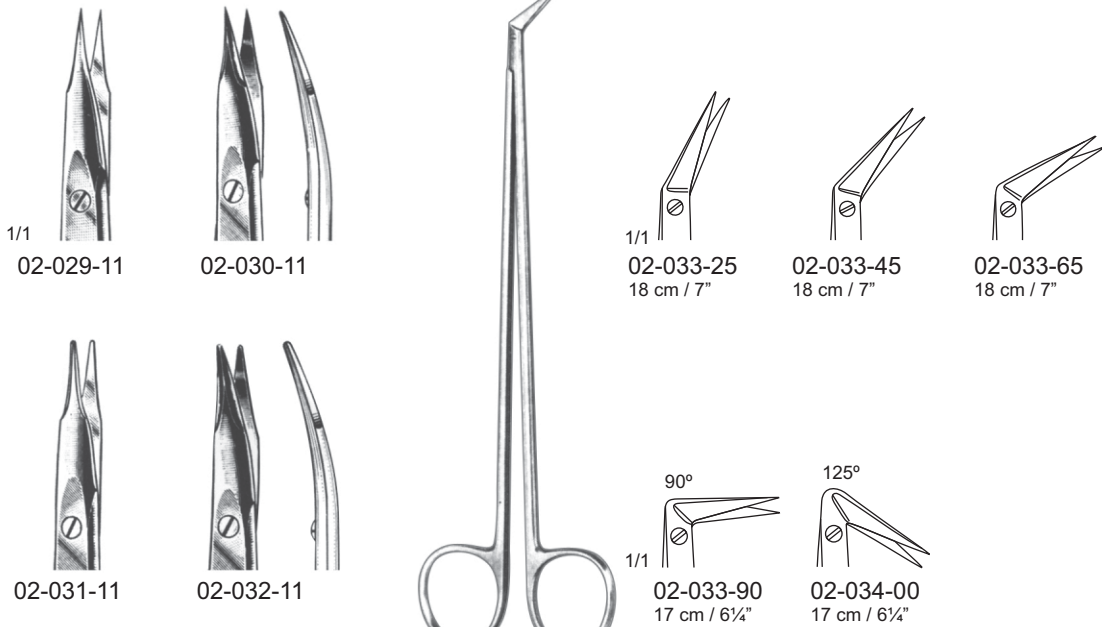

02-029-11

02-030-11

02-033-25  
18 cm / 7"

02-033-45  
18 cm / 7"

02-033-65  
18 cm / 7"

02-031-11

02-032-11

90°  
02-033-90  
17 cm / 6¼"

125°  
02-034-00  
17 cm / 6¼"



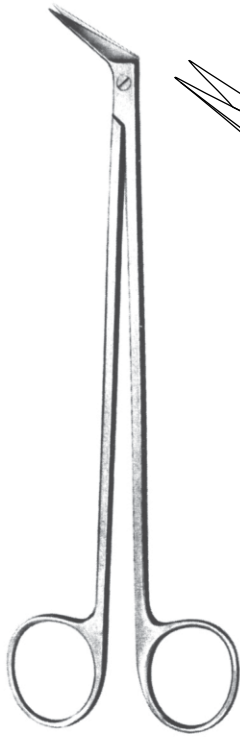

**Potts-Smith**  
02-035-19 - 02-037-19  
19 cm / 7½"

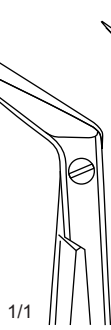

02-035-19  
19 cm / 7½"

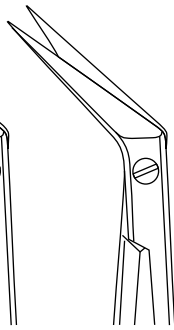

02-036-19  
19 cm / 7½"

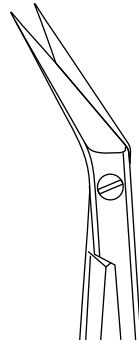

02-037-19  
19 cm / 7½"

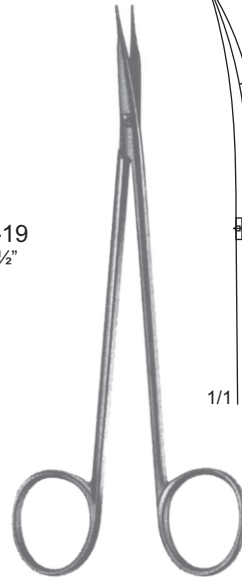

**Jameson**  
02-038-15  
15 cm / 6"

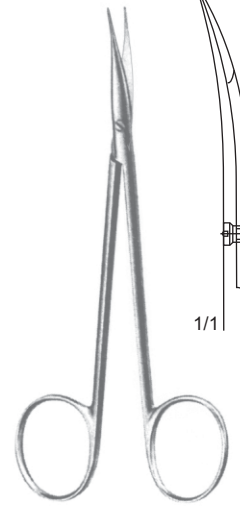

**Jameson**  
02-039-13  
13 cm / 5"



**Spencer**  
02-040-09  
09 cm / 3½"

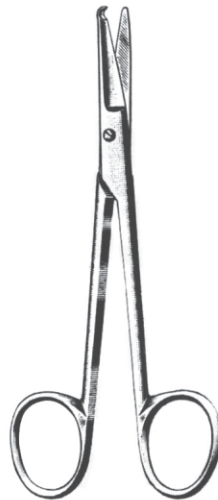

**Spencer**  
02-040-13  
13 cm / 5"

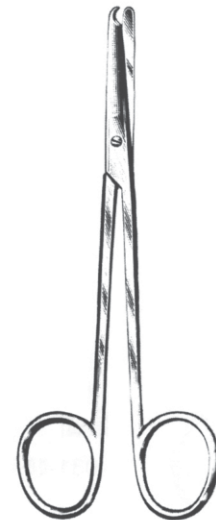

**Littauer**  
02-040-14  
14 cm / 5½"

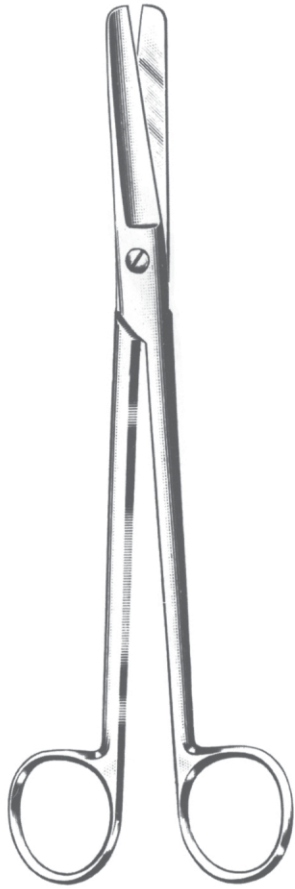

Sims  
02-041-20 - 02-042-23

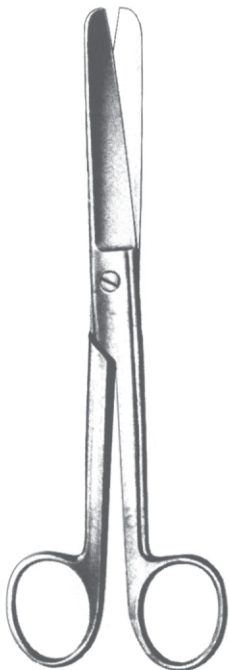
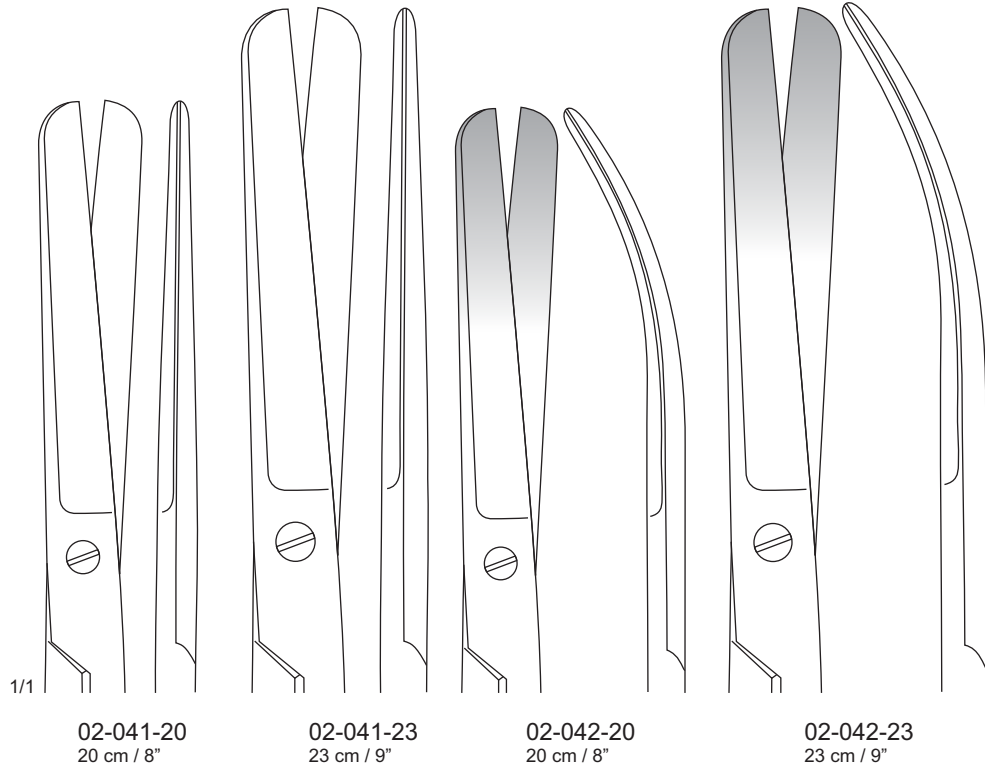

Doyen  
02-043-17 - 02-044-17

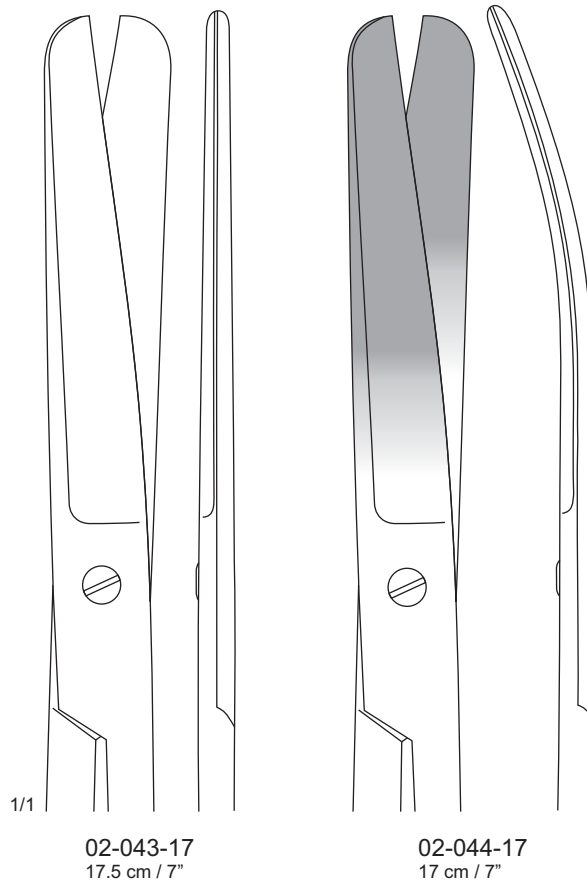

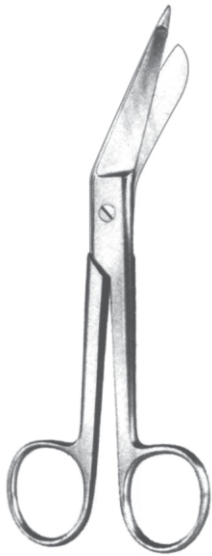

**Lister**  
02-045-09 9 cm / 3½"  
02-045-14 14 cm / 5½"  
02-045-18 18 cm / 7"  
02-045-20 20 cm / 8"

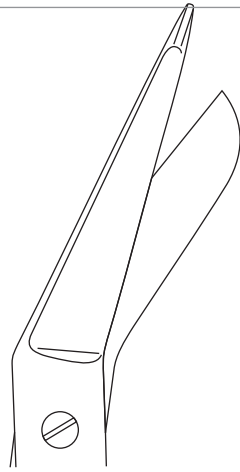

**Lister Utility**  
02-046-15 15 cm / 6"  
02-046-18 18 cm / 7"

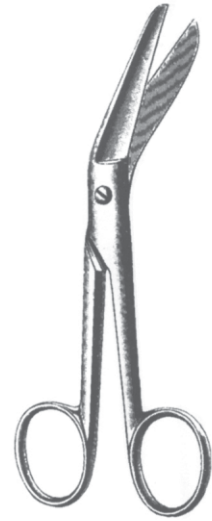

**Richter**  
02-047-13 13 cm / 5½"  
02-047-14 14,5 cm / 5¾"

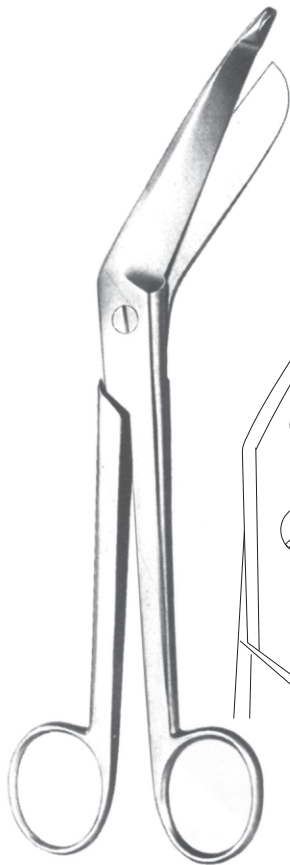

**Bergmann**  
02-048-23  
23 cm / 9"

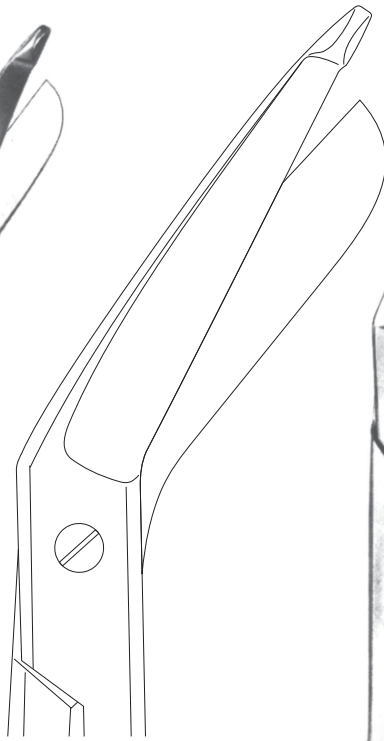

1/1

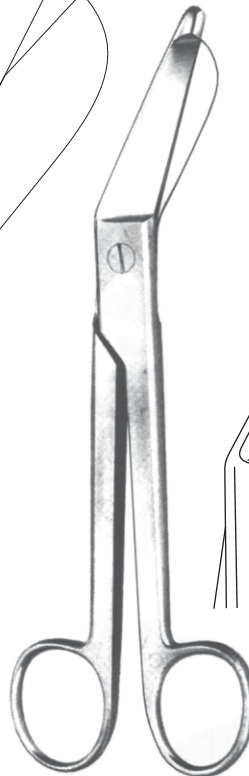

**Esmarch**  
02-049-20 20 cm / 8"  
02-049-22 22 cm / 8¾"

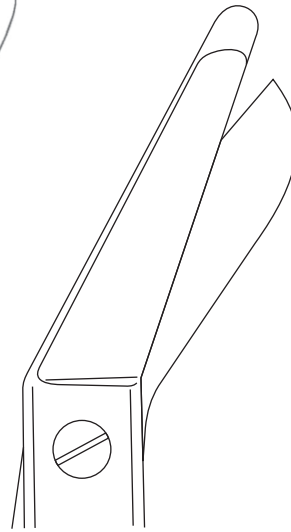

1/1

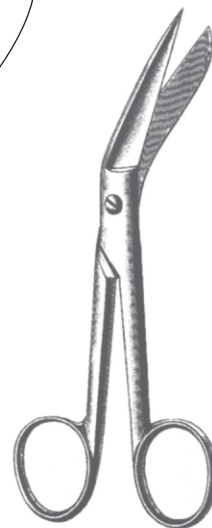

**Richter**  
02-050-20 13 cm / 5½"  
02-050-22 14,5 cm / 8¾"



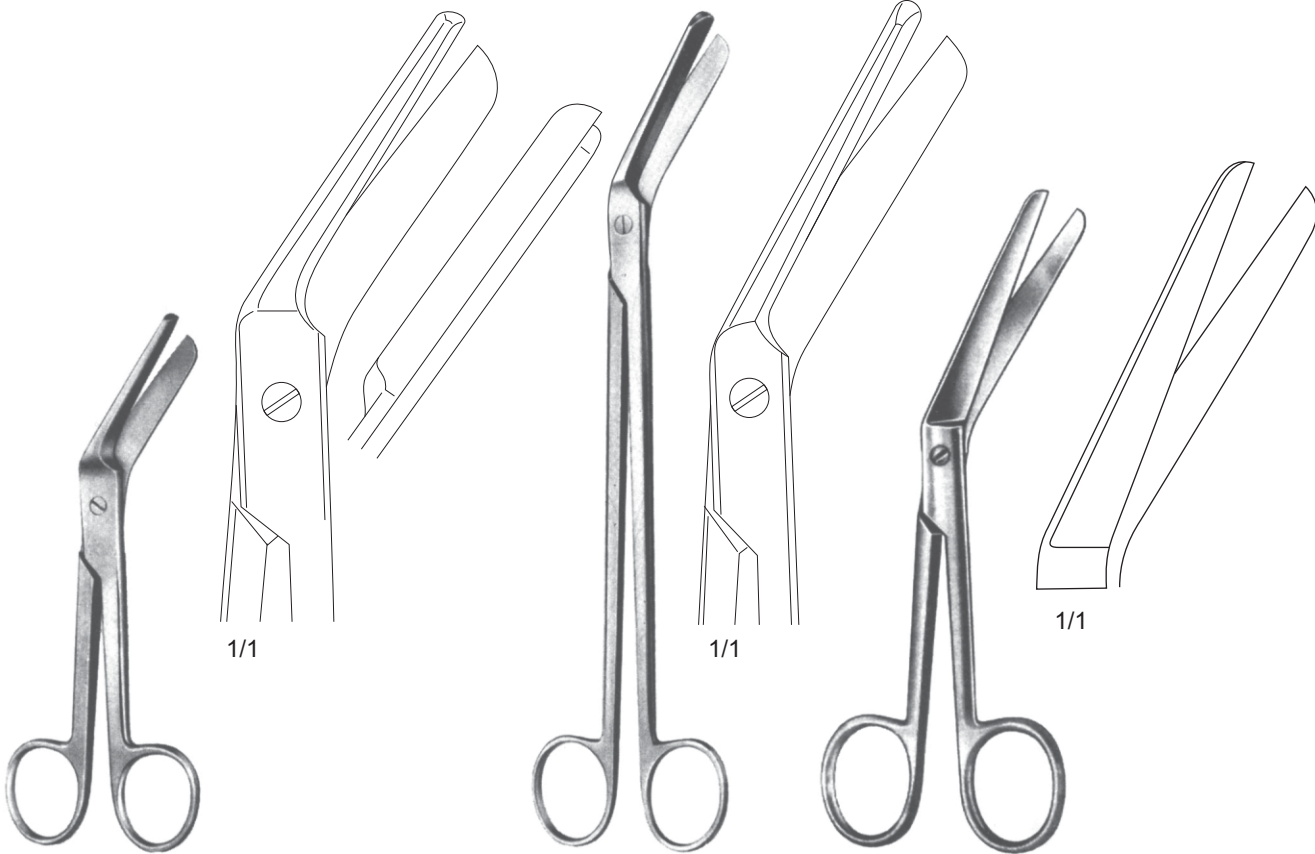

Braun-Stadler  
02-051-14  
14.5 cm / 5½"

Braun-Stadler  
02-052-22  
22 cm / 8¾"

Richter  
02-053-13 13 cm / 5¼"  
02-053-14 14.5 cm / 5¾"



Busch  
02-054-16  
16 cm / 6¼"

Mod. USA  
02-055-10  
10.5 cm / 4¼"

Universal  
02-056-12  
12 cm / 4¾"



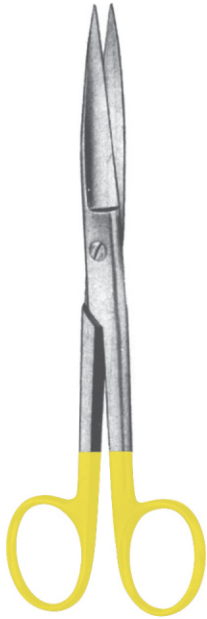

Standard TC (Str.)  
02-057-12 - 02-057-15

1/1

02-057-11  
11.5 cm / 4½"

02-057-13  
13.0 cm / 5"

02-057-14  
14.5 cm / 5½"

02-057-15  
15.5 cm / 6"

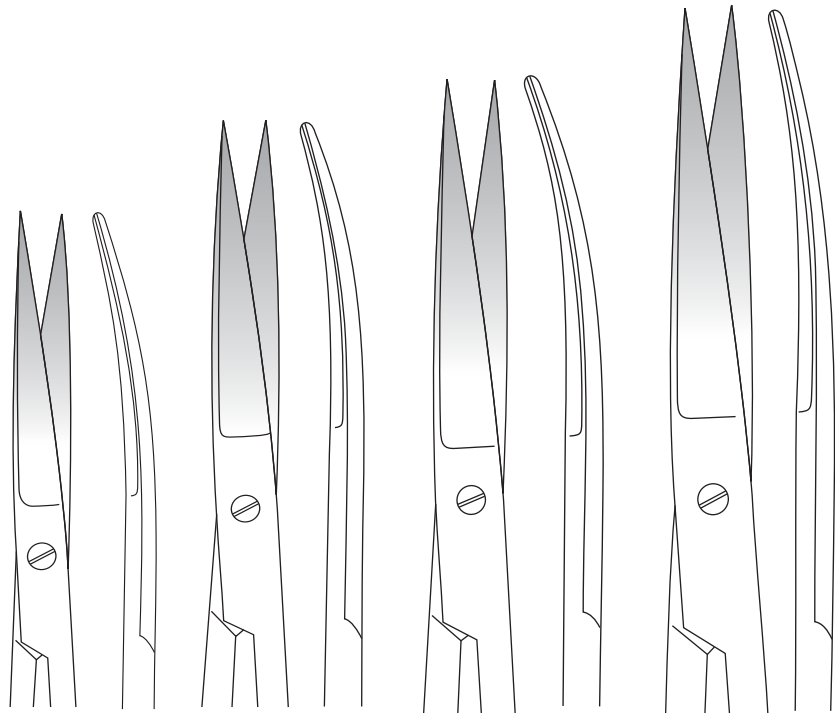

02-058-11  
11.5 cm / 4½"

02-058-13  
13.0 cm / 5"

02-058-14  
14.5 cm / 5½"

02-058-16  
15.5 cm / 6½"



Standard TC (Cvd.)  
02-058-11 - 02-058-16

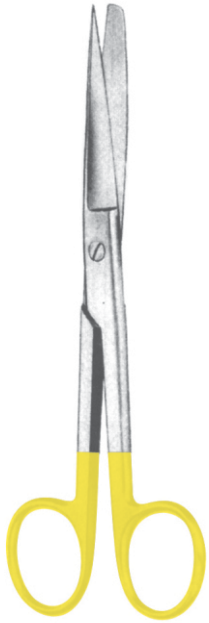

Standard TC (S/B, Str.)  
02-059-11 - 02-059-18

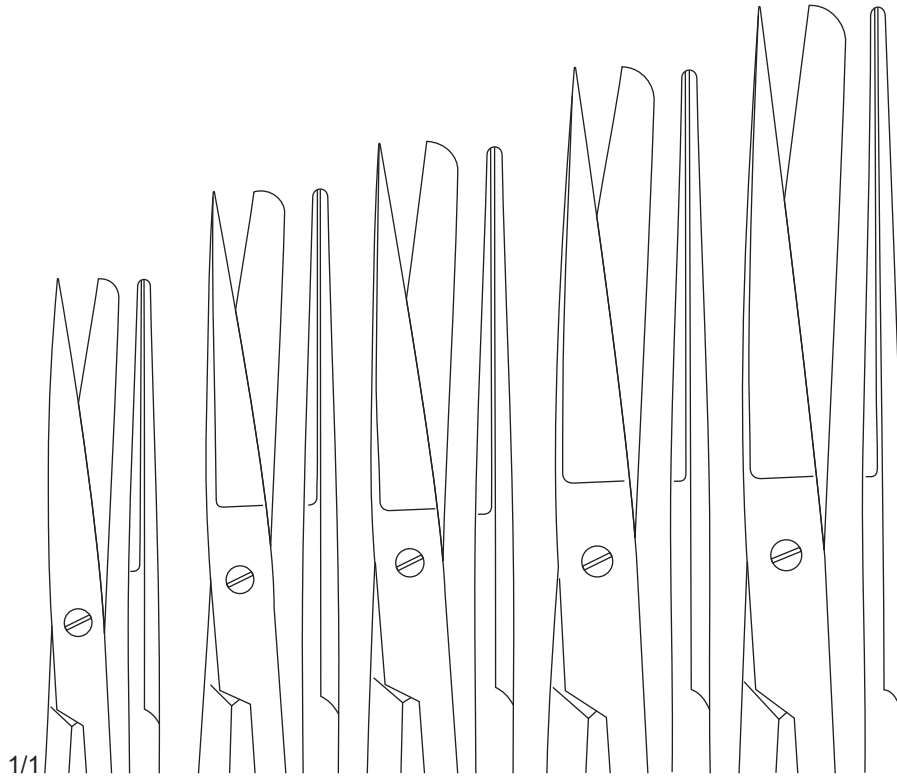

02-059-11  
11.5 cm / 4½"

02-059-13  
13.0 cm / 5"

02-059-14  
14.5 cm / 5½"

02-059-16  
16.5 cm / 6½"

02-059-18  
18 cm / 7½"

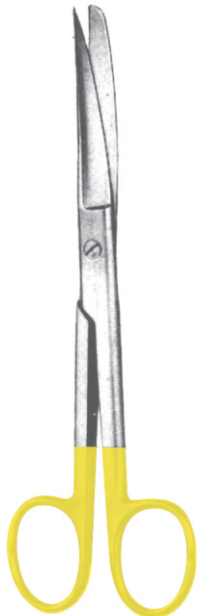

Standard TC (S/B, Cvd.)  
02-060-11 - 02-060-18

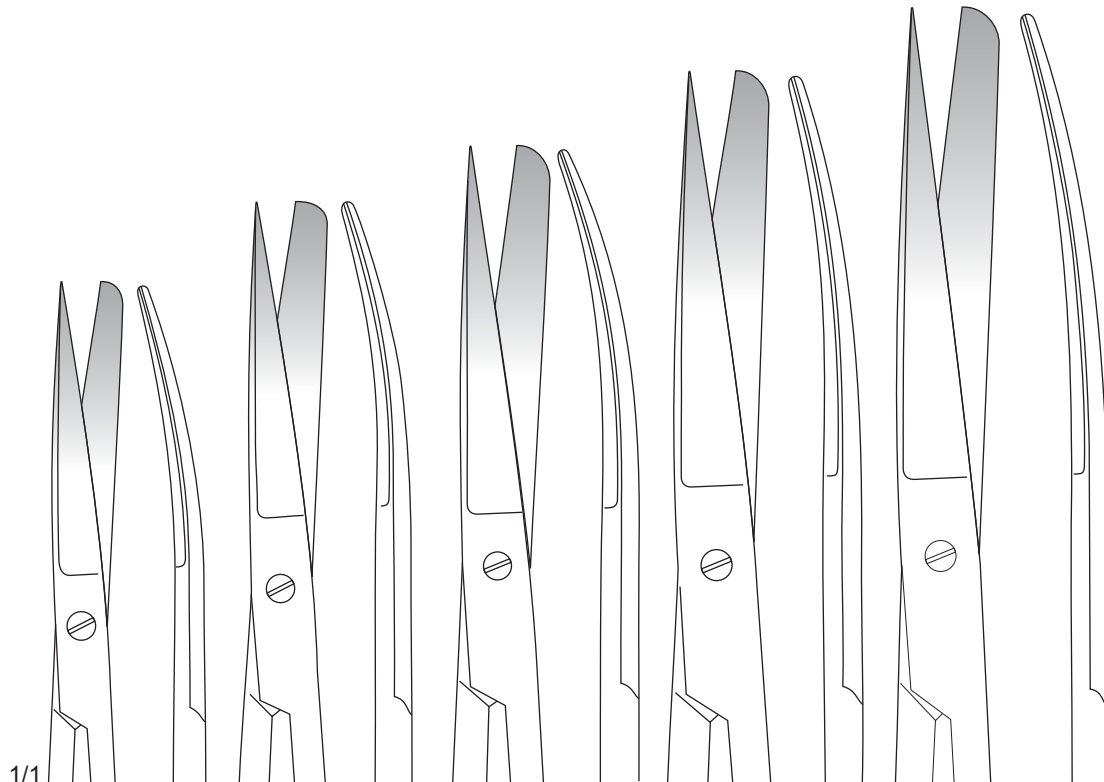

02-060-11  
11.5 cm / 4½"

02-060-13  
13.0 cm / 5"

02-060-14  
14.5 cm / 5½"

02-060-16  
16.5 cm / 6½"

02-060-18  
18 cm / 7½"





Standard TC (B/B, Str.)  
02-061-10 - 02-061-18

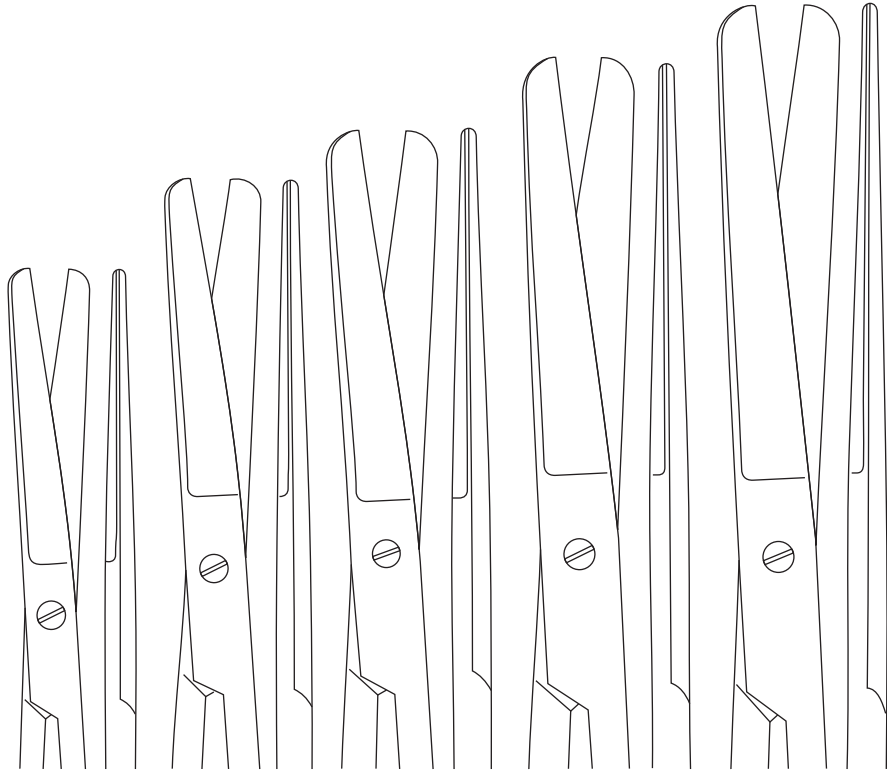

02-061-11  
11.5 cm / 4½"

02-061-13  
13.0 cm / 5"

02-061-14  
14.5 cm / 5½"

02-061-16  
16.5 cm / 6½"

02-061-18  
18.5 cm / 7½"

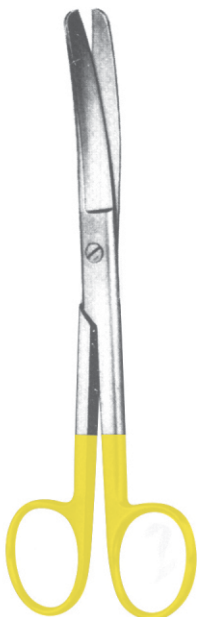

Standard TC (B/B, Cvd.)  
02-062-11 - 02-062-18

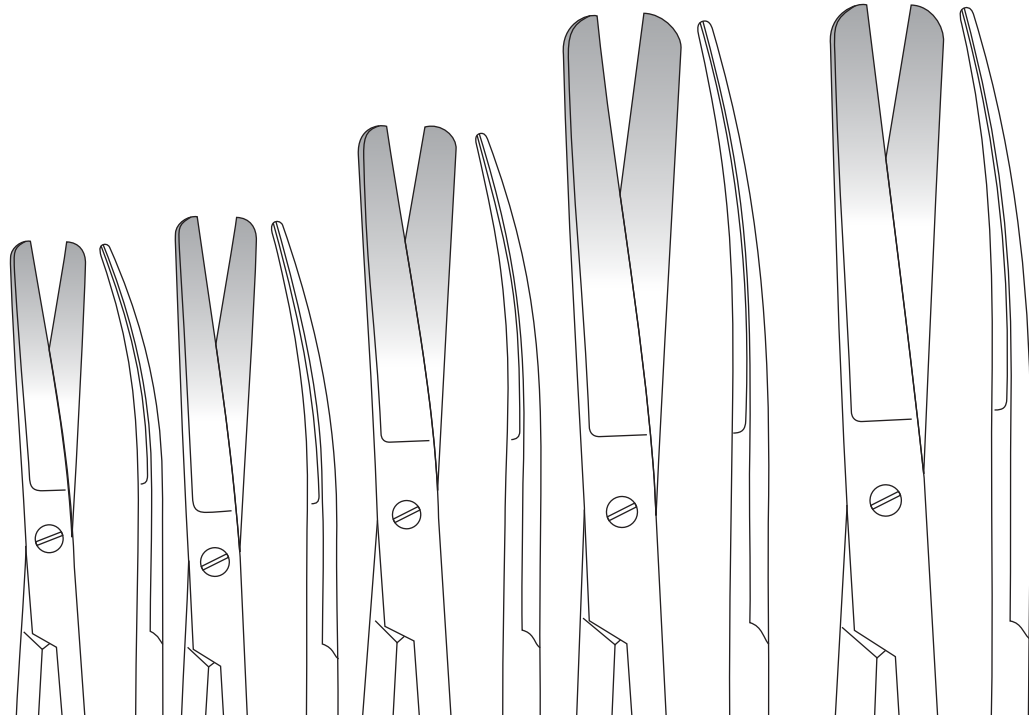

02-062-11  
11.5 cm / 4½"

02-062-13  
13.0 cm / 5"

02-062-14  
14.5 cm / 5½"

02-062-16  
16.5 cm / 6½"

02-062-18  
18.5 cm / 7½"

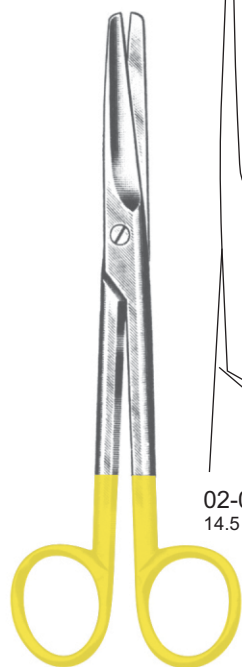

Mayo TC  
02-063-14 - 02-064-28

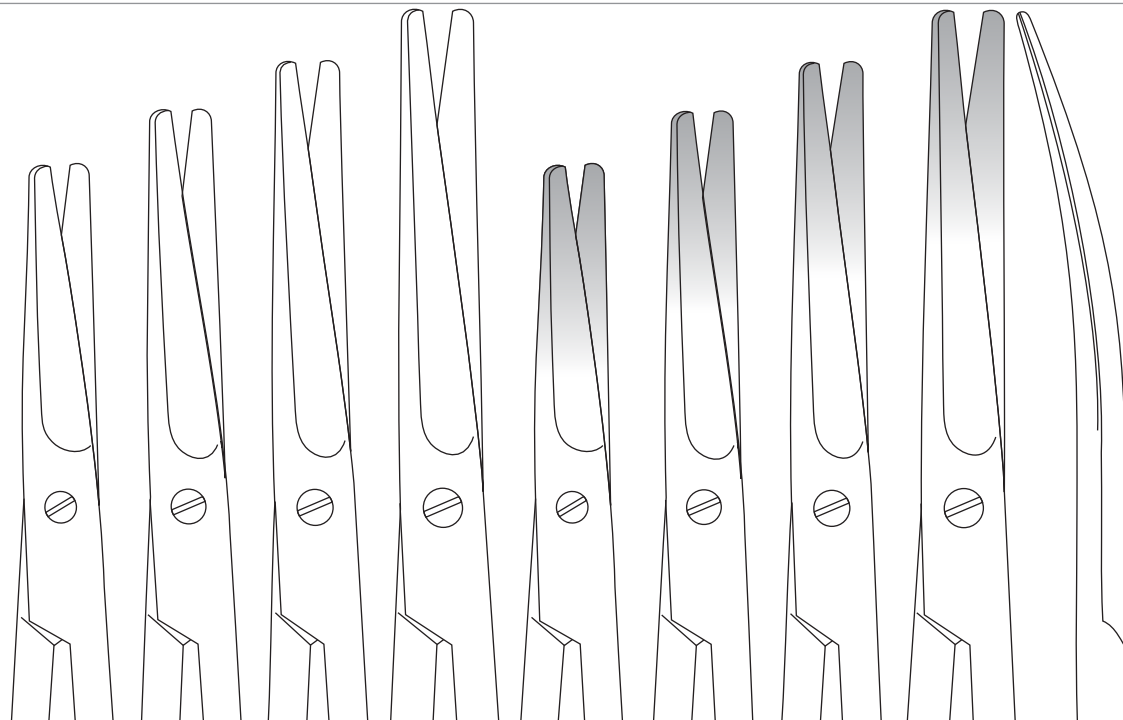

02-063-14	02-063-15	02-063-17	02-063-23	02-064-14	02-064-15	02-064-17	02-064-23
14.5 cm / 5½"	15 cm / 6"	17 cm / 6¾"	23 cm / 9"	14.5 cm / 5½"	15 cm / 6"	17 cm / 6¾"	23 cm / 9"

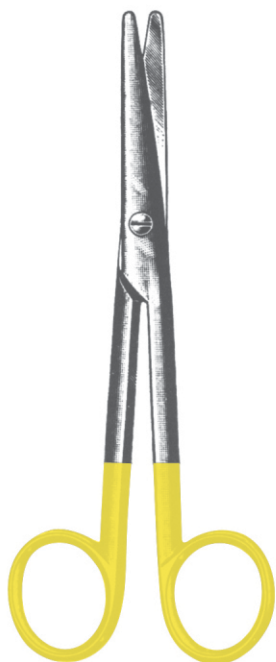

Mayo-Stille TC  
02-065-15 - 02-066-17

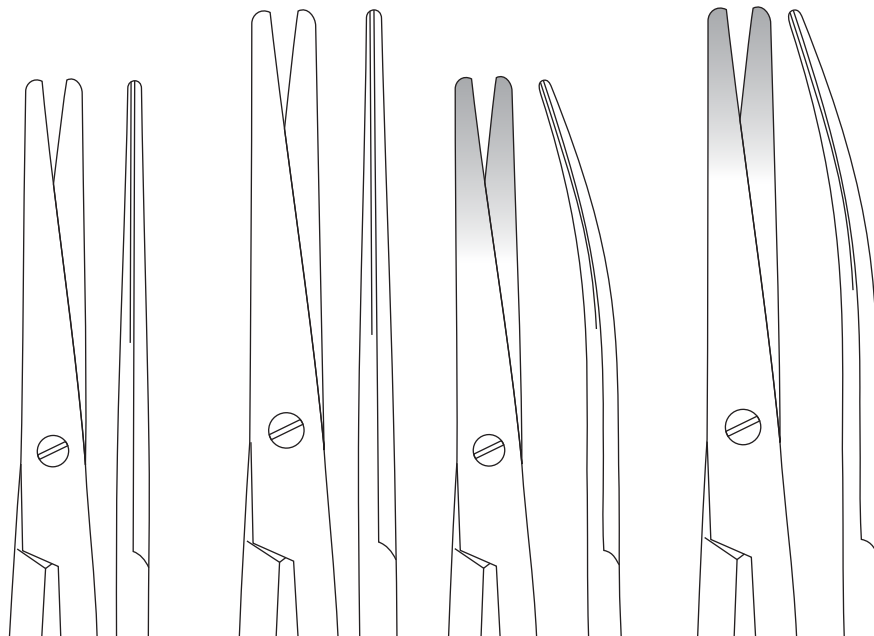

02-065-15	02-065-17	02-066-15	02-066-17
15 cm / 6"	17 cm / 6¾"	15 cm / 6¾"	17 cm / 6¾"



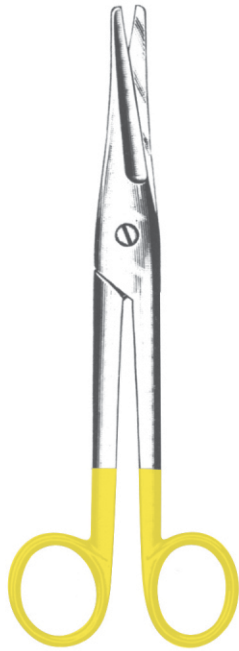

**Mayo-Noble TC**  
02-067-17 - 02-068-17  
17 cm / 6 3/4"

1/1



02-067-17  
Str.

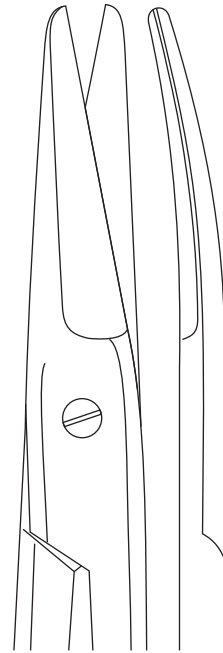

02-068-17  
Cvd.

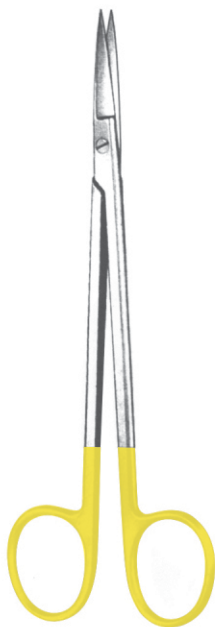

**Kelly TC**  
02-069-16 - 02-070-18

1/1



02-069-16  
16 cm / 6 1/2"

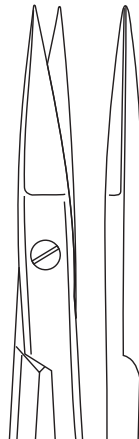

02-070-18  
18 cm / 7 1/4"

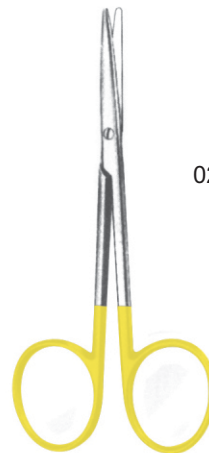

**Baby Metzenbaum TC**  
02-071-11 - 02-072-11  
11.5 cm / 4 1/2"

02-071-11

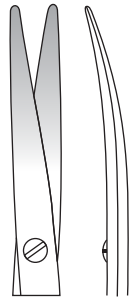

02-072-11

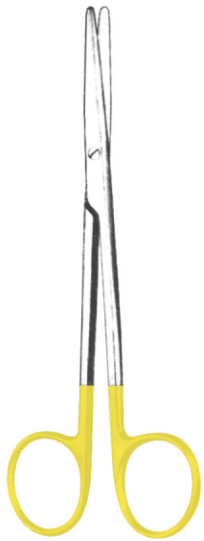

Metzenbaum TC  
02-073-14 - 02-078-14

B/B	S/B	S/S
1/1		
02-073-14 14 cm / 5½" str	02-075-14 14 cm / 5½" str	02-077-14 14 cm / 5½" str
02-074-14 14 cm / 5½" cvd	02-076-14 14 cm / 5½" cvd	02-078-14 14 cm / 5½" cvd
02-073-15 15 cm / 6" str	02-075-15 15 cm / 6" str	02-077-15 15 cm / 6" str
02-074-15 15 cm / 6" cvd	02-076-15 15 cm / 6" cvd	02-078-15 15 cm / 6" cvd
02-073-18 18 cm / 7" str	02-075-18 18 cm / 7" str	02-077-18 18 cm / 7" str
02-074-18 18 cm / 7" cvd	02-076-18 18 cm / 7" cvd	02-078-18 18 cm / 7" cvd
02-073-20 20 cm / 8" str	02-075-20 20 cm / 8" str	02-077-20 20 cm / 8" str
02-074-20 20 cm / 8" cvd	02-076-20 20 cm / 8" cvd	02-078-20 20 cm / 8" cvd
02-073-23 23 cm / 9" str	02-075-23 23 cm / 9" str	02-077-23 23 cm / 9" str
02-074-23 23 cm / 9" cvd	02-076-23 23 cm / 9" cvd	02-078-23 23 cm / 9" cvd
02-073-25 25 cm / 10" str	02-075-25 25 cm / 10" str	02-077-25 25 cm / 10" str
02-074-25 25 cm / 10" cvd	02-076-25 25 cm / 10" cvd	02-078-25 25 cm / 10" cvd
02-073-28 28 cm / 11" str	02-075-28 28 cm / 11" str	02-077-28 28 cm / 11" str
02-074-28 28 cm / 11" cvd	02-076-28 28 cm / 11" cvd	02-078-28 28 cm / 11" cvd
02-073-30 30 cm / 12" str	02-075-30 30 cm / 12" str	02-077-30 30 cm / 12" str
02-074-30 30 cm / 12" cvd	02-076-30 30 cm / 12" cvd	02-078-30 30 cm / 12" cvd



Gorney TC  
02-079-12 - 02-080-19

1/1		
02-079-12 12.5 cm / 5" Str.	02-079-19 19.5 cm / 7¾" Str.	02-080-19 19.5 cm / 7¾" Cvd.



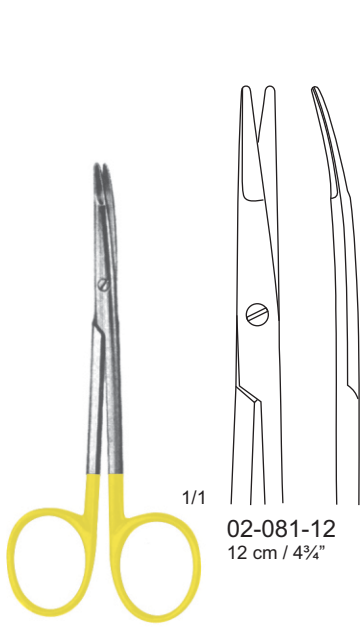

1/1  
02-081-12  
12 cm / 4 3/4"

**Kilner TC**  
02-081-12 - 02-081-15

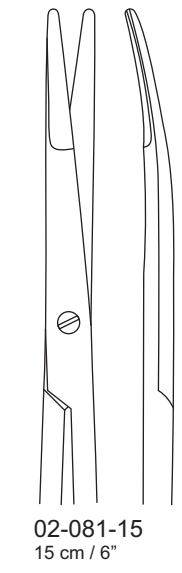

02-081-15  
15 cm / 6"

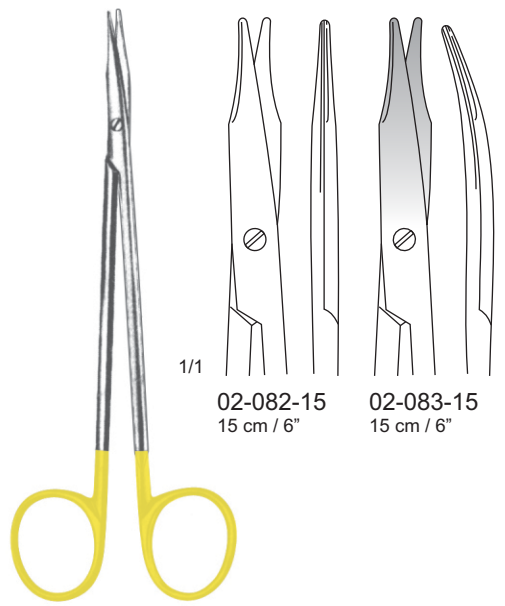

1/1  
02-082-15  
15 cm / 6"      02-083-15  
15 cm / 6"

**Reynolds TC**  
02-082-15 - 02-083-18

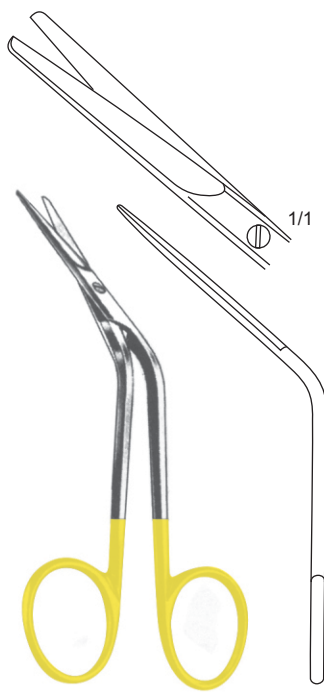

1/1  
02-084-15  
15 cm / 6"

**Fomon TC**  
02-084-15  
15 cm / 6"

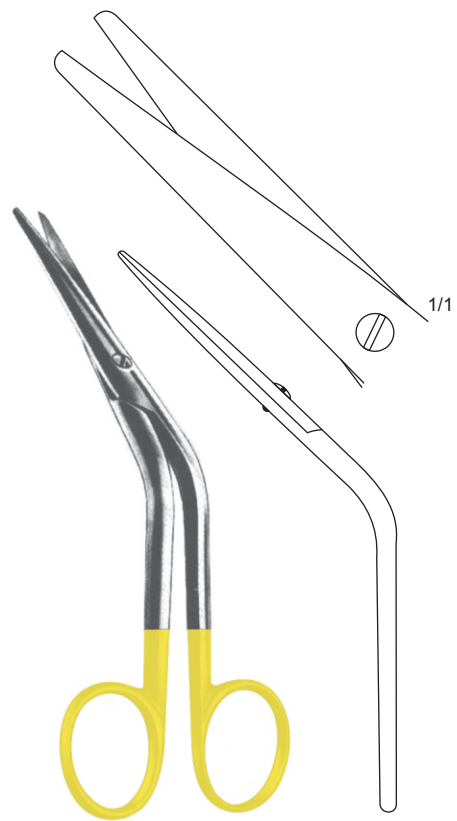

1/1  
02-085-16  
16 cm / 6 1/2"

**Cottle TC**  
02-085-16  
16 cm / 6 1/2"

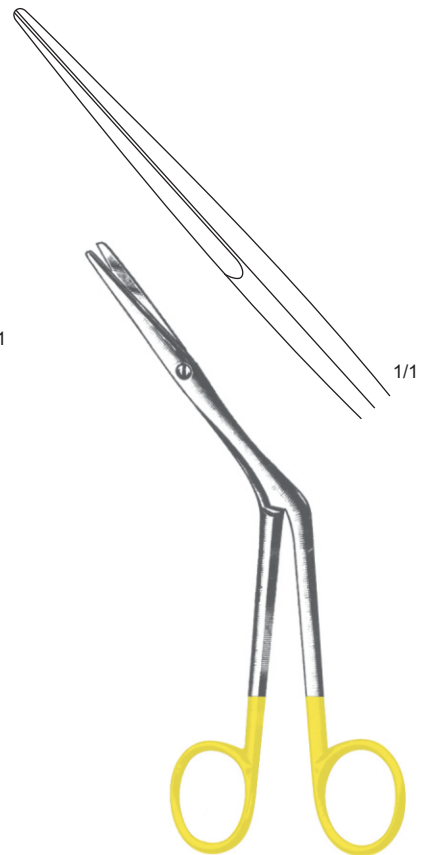

1/1  
02-086-18  
18 cm / 7"

**Heymann TC**  
02-086-18  
18 cm / 7"





**Iris TC**  
02-088-09 - 02-089-10

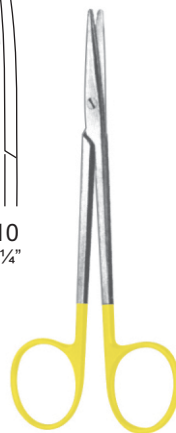
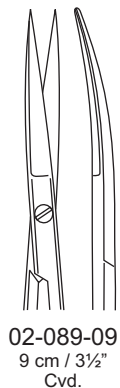
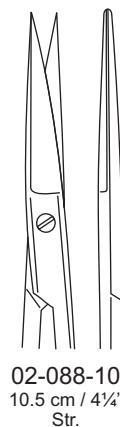
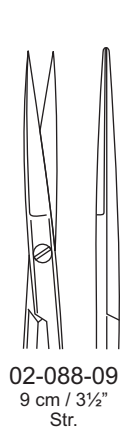

**Strabismus TC**  
02-090-11 - 02-091-11  
11.5 cm / 4½"

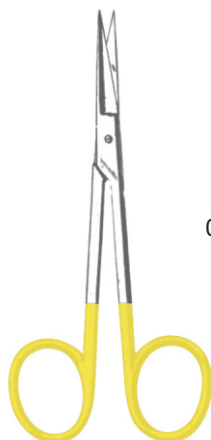
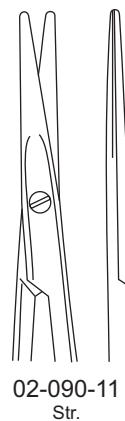

**Iris**  
02-092-11 - 02-095-11  
11.5 cm / 4½"

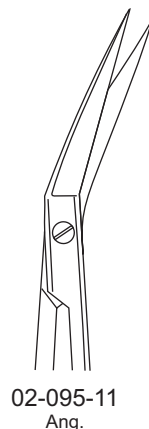
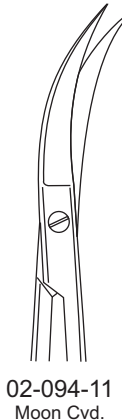
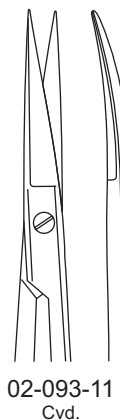
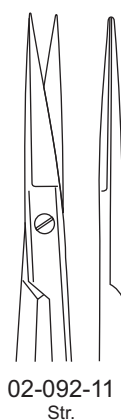

**Wagner TC**  
02-096-12 - 02-097-12  
12 cm / 4¾"

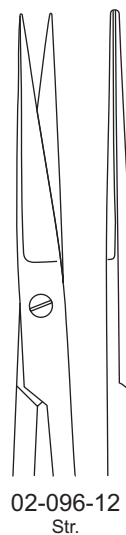



1/1  
02-098-11

02-099-11



02-100-11

02-101-11



**Btrabismus TC**  
02-090-11 - 02-091-11  
11.5 cm / 4½"

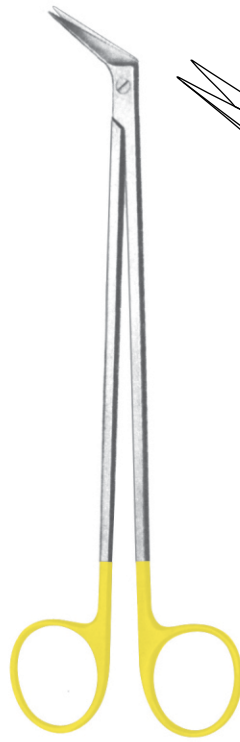

**Btrabismus TC**  
02-090-11 - 02-091-11  
11.5 cm / 4½"

1/1  
02-102-19  
19 cm / 7½"

02-103-19  
19 cm / 7½"

02-104-19  
19 cm / 7½"

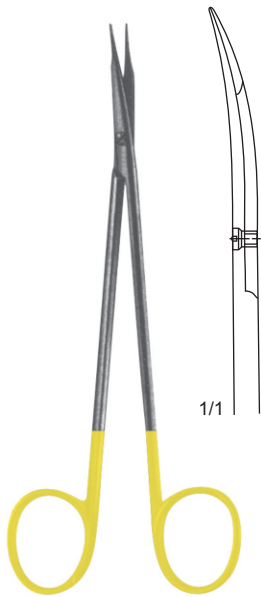

1/1

**Jameson TC**  
02-105-15  
15 cm / 6"

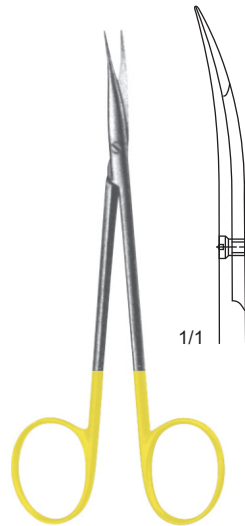

1/1

**Jameson TC**  
02-106-13  
13 cm / 5"

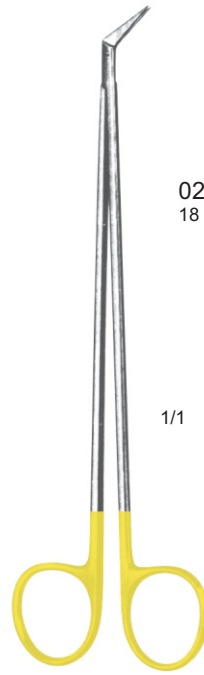

02-107-25  
18 cm / 7"

02-107-45  
18 cm / 7"

02-107-60  
17.5 cm / 7"

1/1  
90°  
02-107-90  
17 cm / 6¾"

125°  
02-108-00  
17 cm / 6¾"

**Dietrich TC**  
02-107-25 - 02-108-00

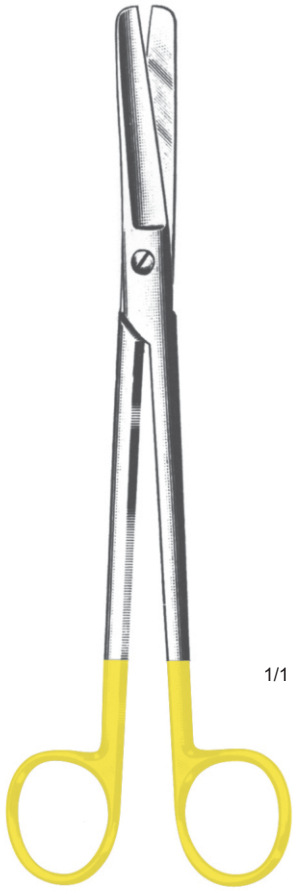

**Sims TC**  
02-109-19 - 02-110-19

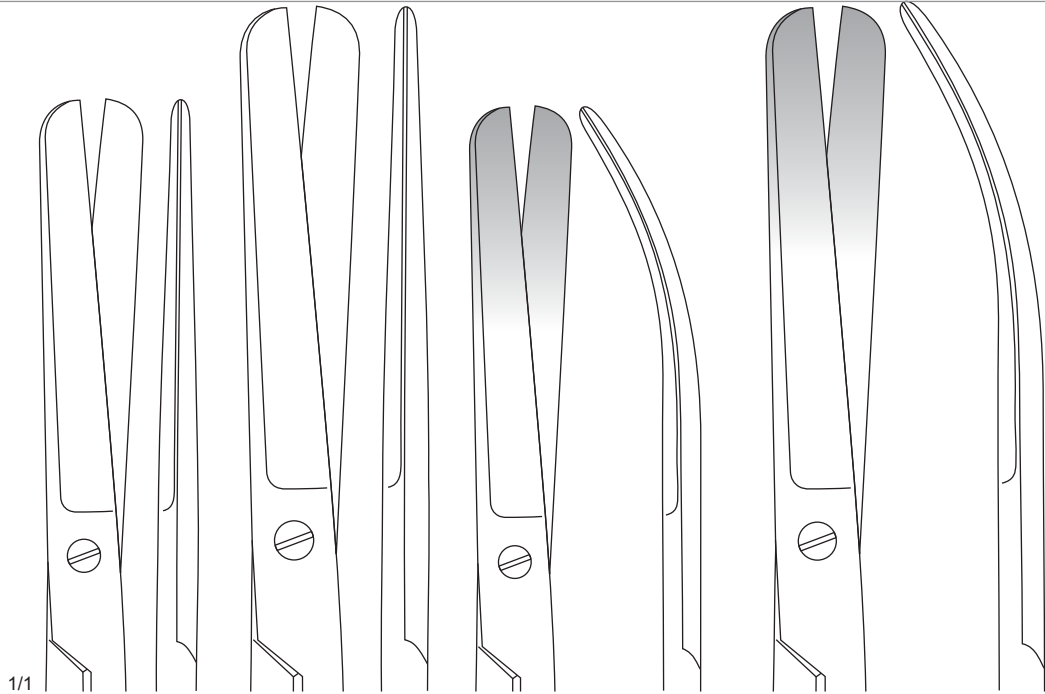

1/1  
02-109-20  
20 cm / 8"  
Str.

02-109-23  
23 cm / 9"  
Str.

02-110-23  
20 cm / 8"  
Cvd.

02-110-23  
23 cm / 9"  
Cvd.

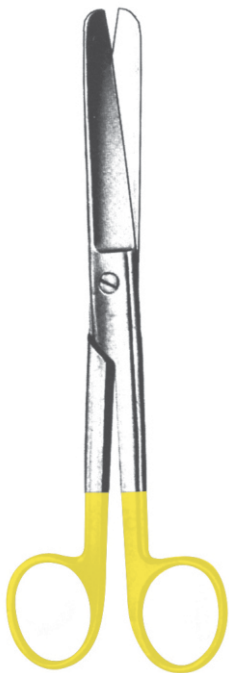

**Doyen TC**  
02-111-17 - 02-112-17

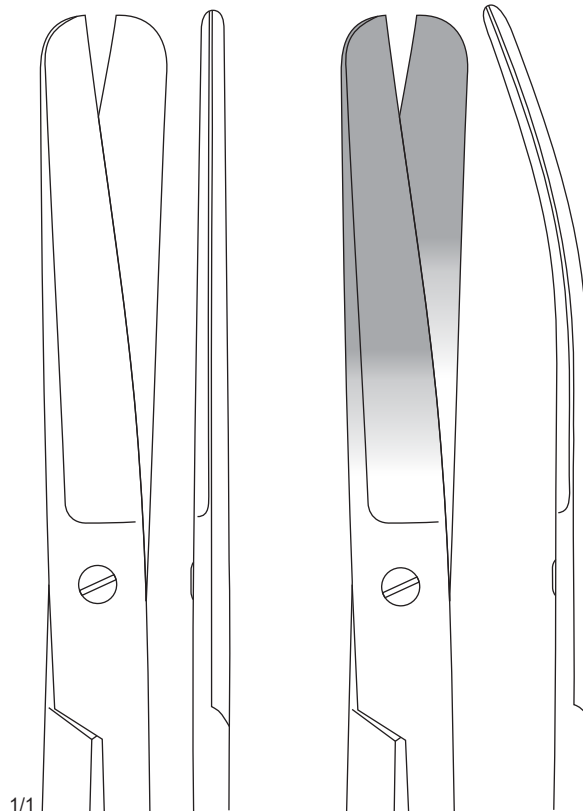

1/1  
02-111-17  
27.5 cm / 7"  
Str.

02-112-17  
27.5 cm / 7"  
Cvd.



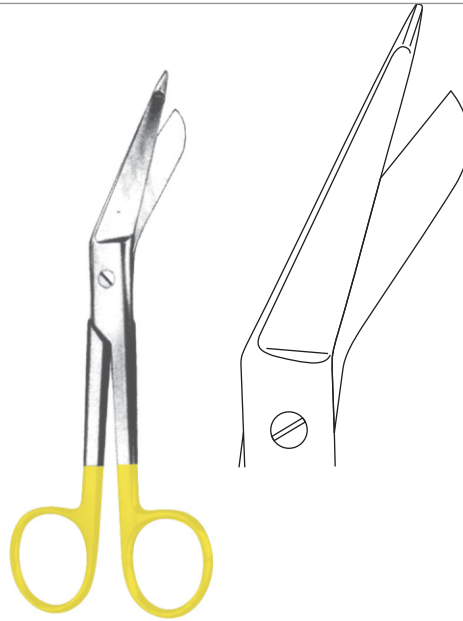

**Lister TC**  
02-113-09 9 cm / 3½"  
02-113-14 14 cm / 5½"  
02-113-18 18 cm / 7"  
02-113-20 20 cm / 8"



**Bergmann TC**  
02-114-23  
23 cm / 9"

**Esmarch TC**  
02-115-20 20 cm / 8"  
02-116-22 22 cm / 8¾"



**Braun-Standler TC**  
02-117-14  
14.5 cm / 5½"

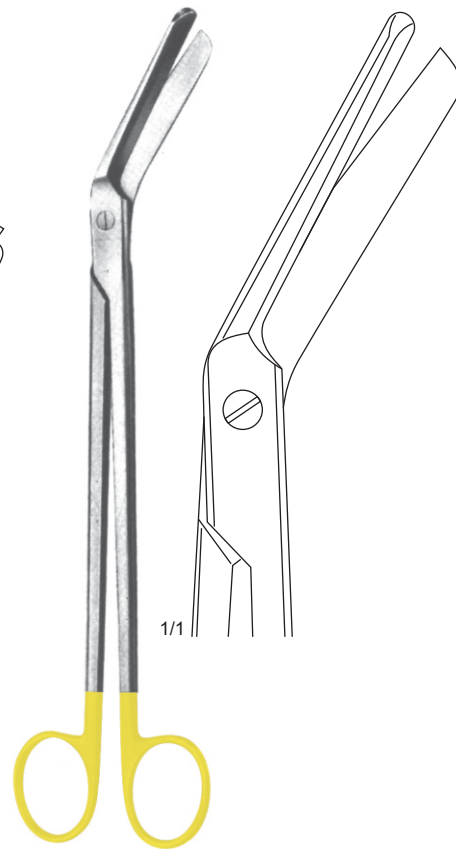

**Braun-Standler TC**  
02-118-22  
22 cm / 8¾"

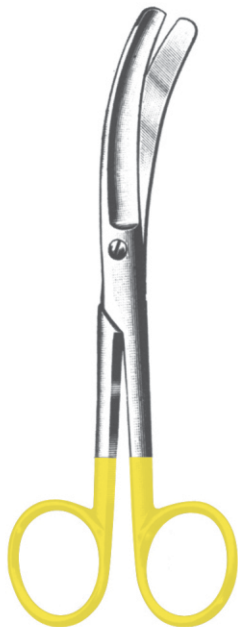

**Busch TC**  
02-119-16  
16 cm / 6¼"

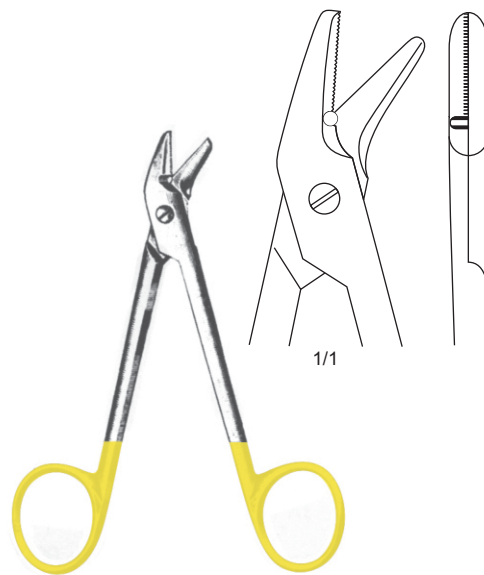

**Universal TC**  
02-120-12  
12 cm / 4½"





Standard SC (S/S, Str.)  
02-121-11 - 02-124-16

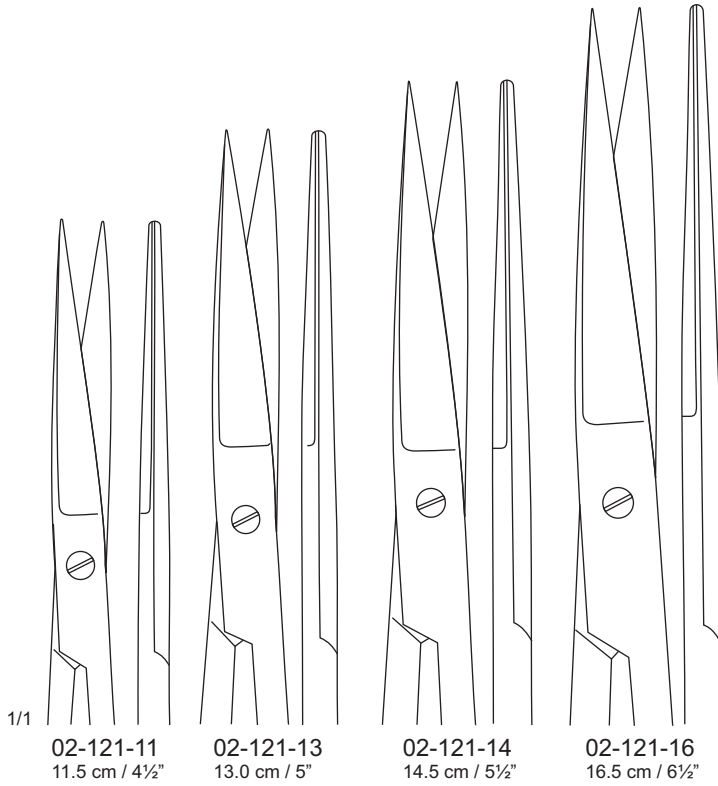

Standard SC (S/S, Cvd.)  
02-122-11 - 02-122-16

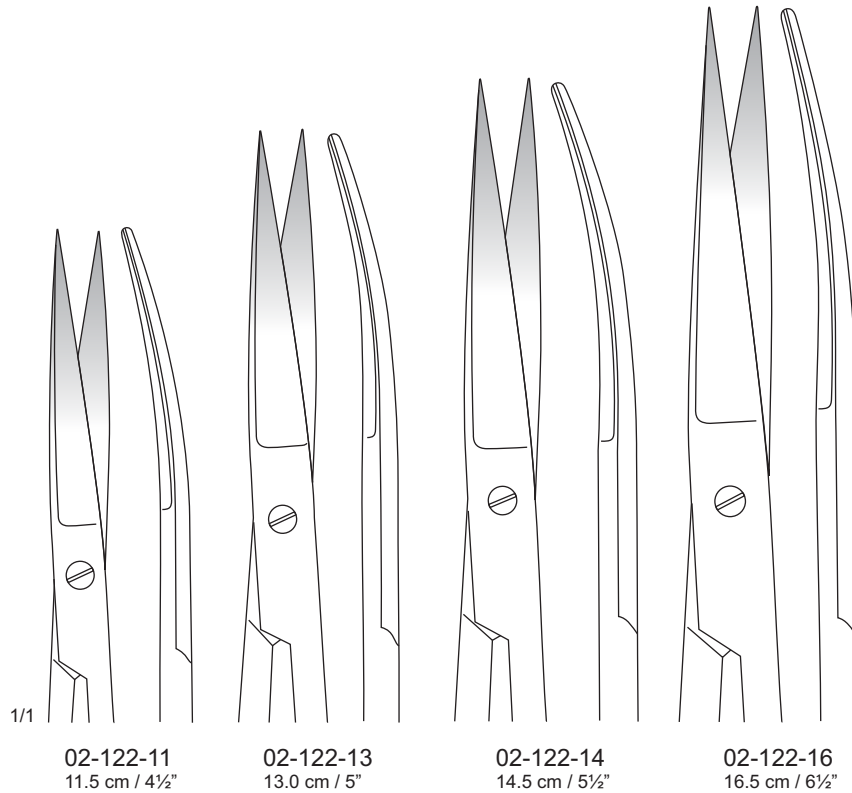

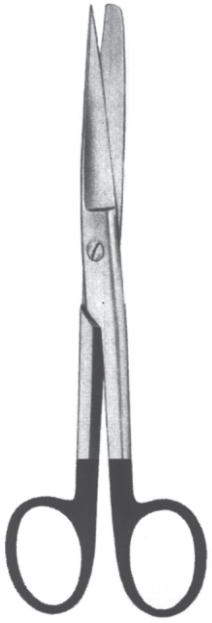

Standard **SC** (S/B, Str.)  
02-123-11 - 02-123-18

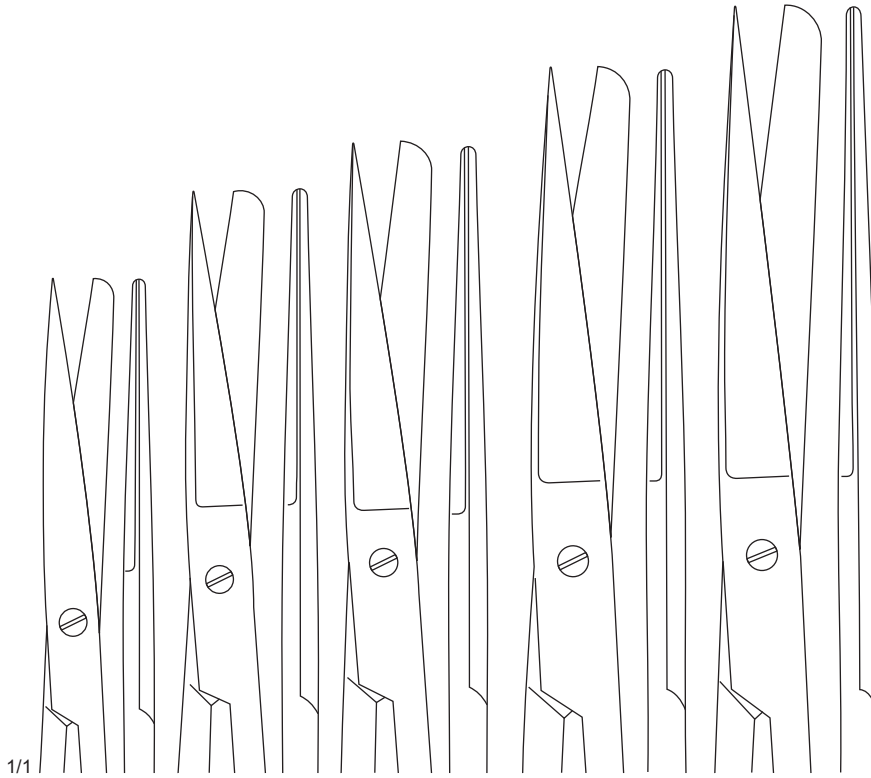

02-123-11  
11.5 cm / 4½"

02-123-13  
13.0 cm / 5½"

02-123-14  
14.5 cm / 5½"

02-123-16  
16.5 cm / 6½"

02-123-18  
18.5 cm / 7½"

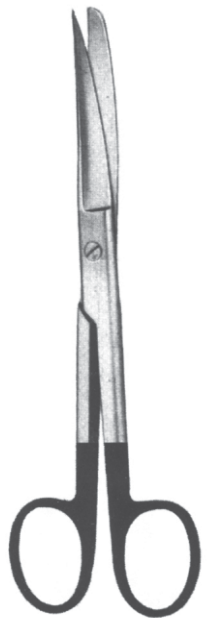

Standard **SC** (S/B, Cvd.)  
02-124-11 - 02-124-18

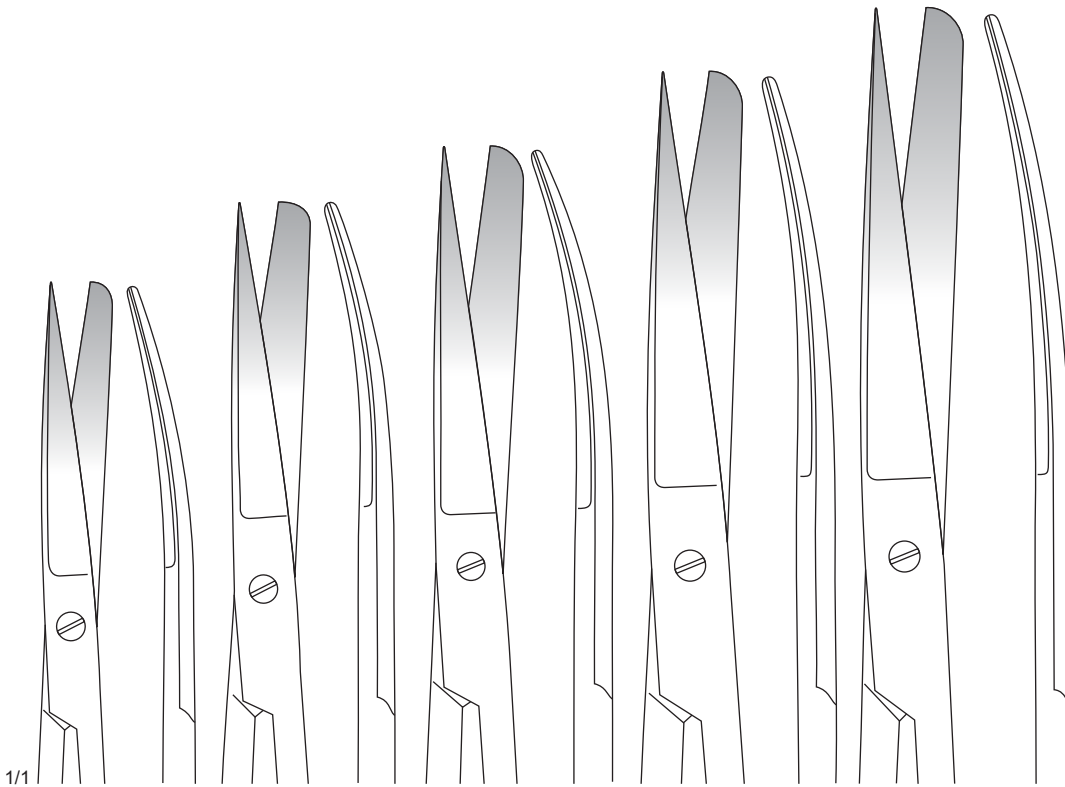

02-124-11  
11.5 cm / 4½"

02-124-13  
13.0 cm / 5½"

02-124-14  
14.5 cm / 5½"

02-124-16  
16.5 cm / 6½"

02-124-18  
18.5 cm / 7½"





Standard SC (B/B, Str.)  
02-125-11 - 02-125-18

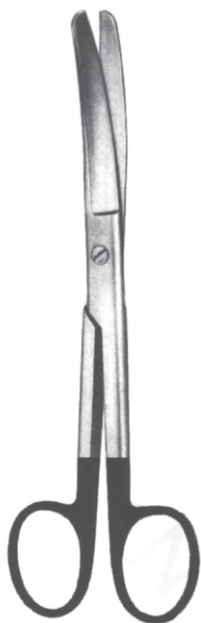
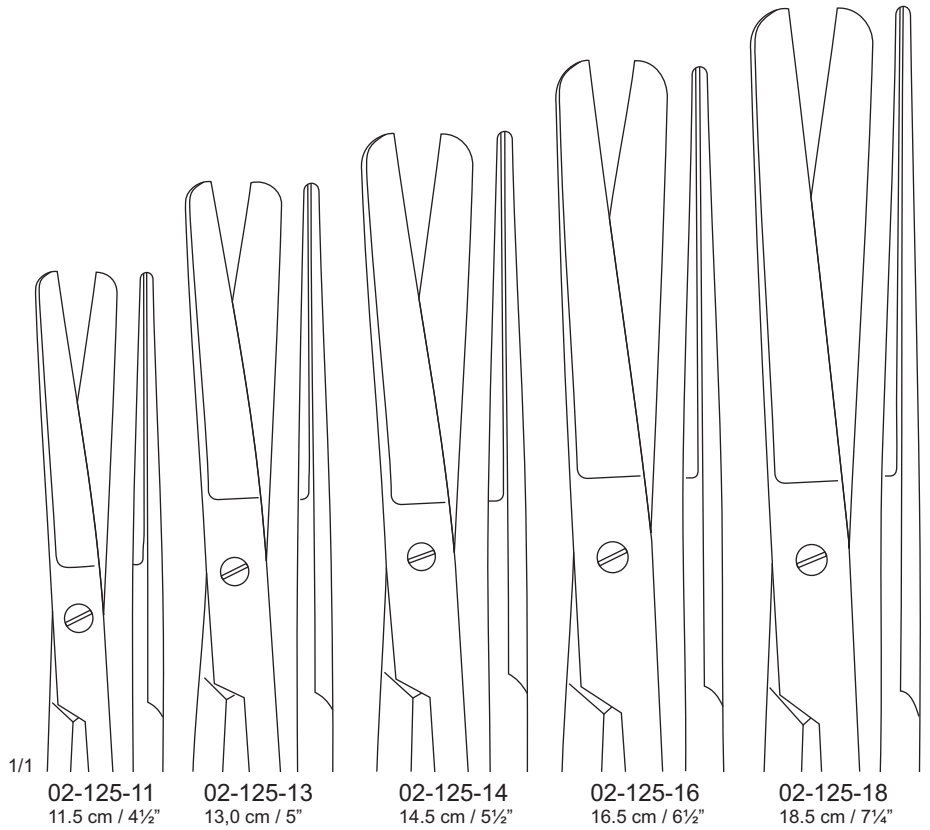

Standard SC (B/B, Cvd.)  
02-126-11 - 02-126-18

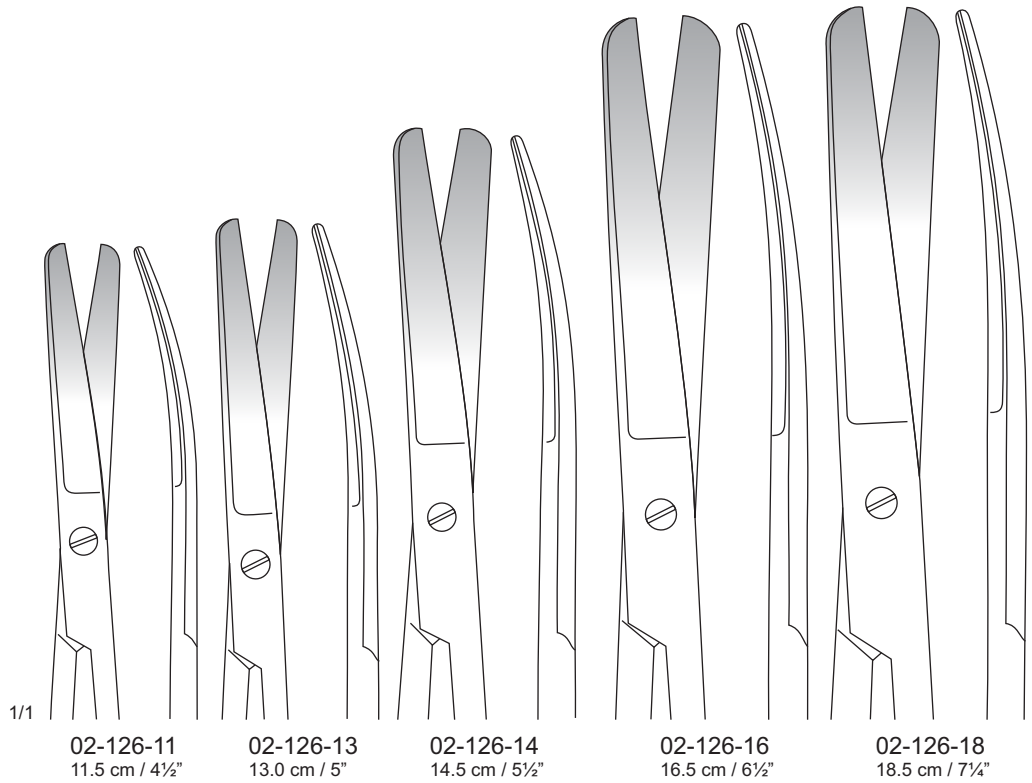



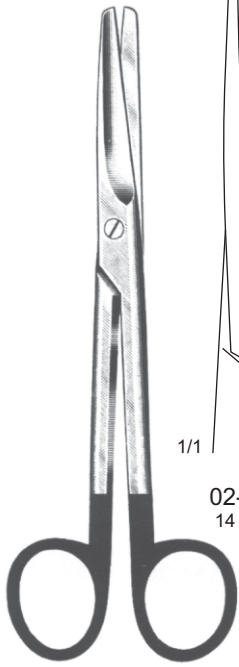

**Mayo SC**  
02-127-14 - 02-128-23

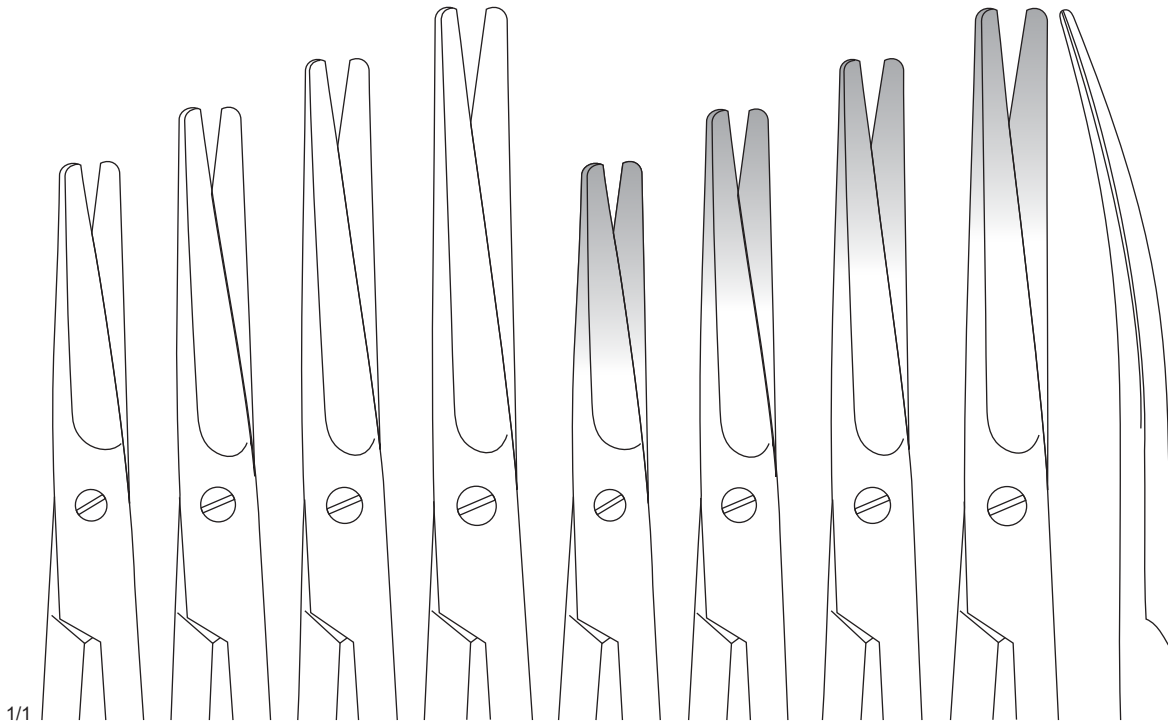

02-127-14 14 cm / 5½" Str.	02-127-15 15 cm / 6" Str.	02-127-17 17 cm / 6¾" Str.	02-127-23 23 cm / 9" Str.	02-128-14 14 cm / 5½" Cvd.	02-128-15 15 cm / 6" Cvd.	02-128-17 17 cm / 6¾" Cvd.	02-128-23 23 cm / 9" Cvd.
----------------------------------	---------------------------------	----------------------------------	---------------------------------	----------------------------------	---------------------------------	----------------------------------	---------------------------------

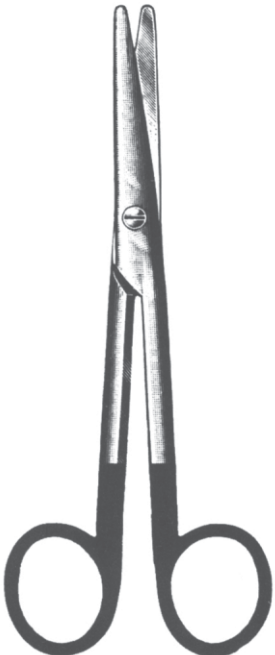

**Mayo-Stille SC**  
02-129-15 - 02-130-17

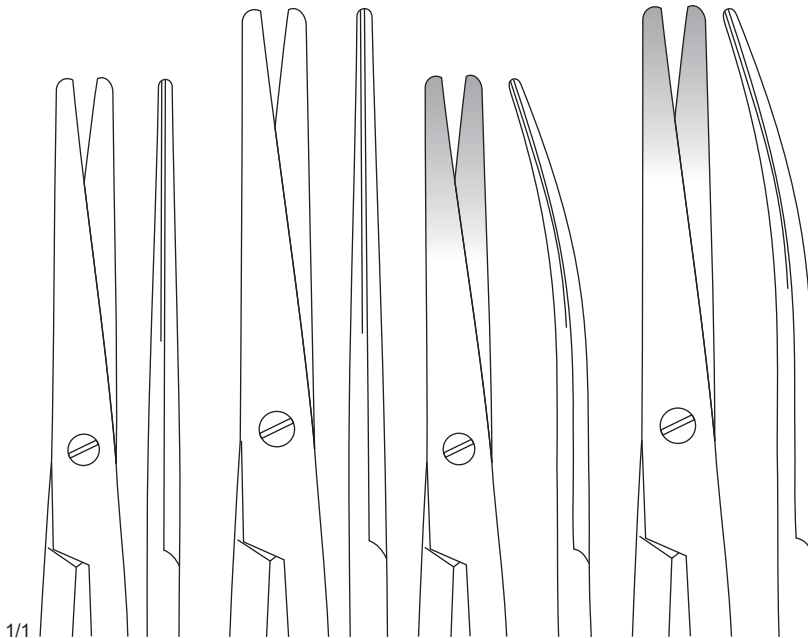

02-129-15 15 cm / 6" Str.	02-129-17 17 cm / 6¾" Str.	02-130-15 15 cm / 6" Cvd.	02-130-17 17 cm / 6¾" Cvd.
---------------------------------	----------------------------------	---------------------------------	----------------------------------



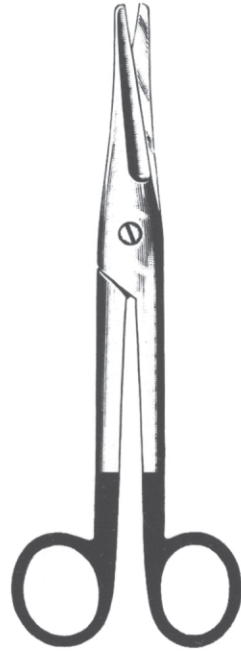

**Mayo-Noble SC**  
02-131-17 - 02-132-17  
17 cm / 6 3/4"

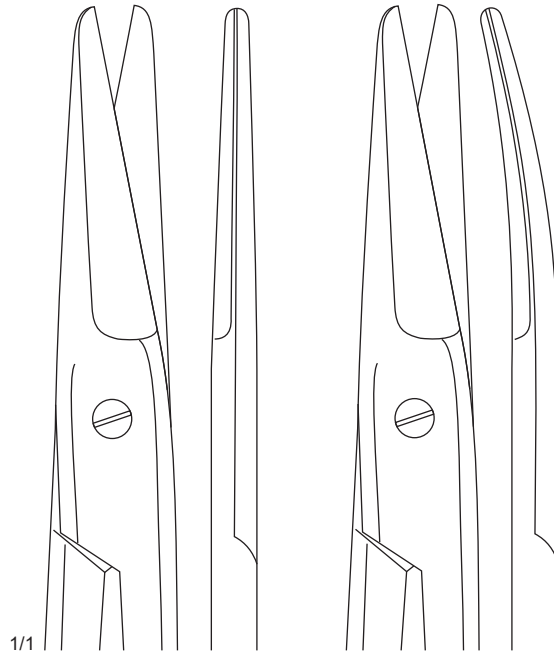

02-131-17  
Str.

02-132-17  
Cvd.

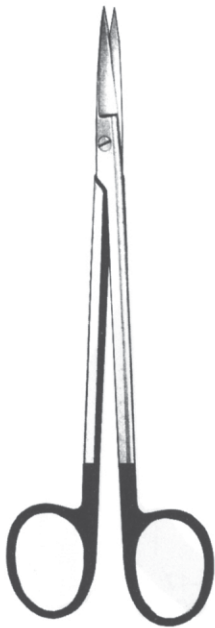

**Kelly SC**  
02-133-16 - 02-134-18

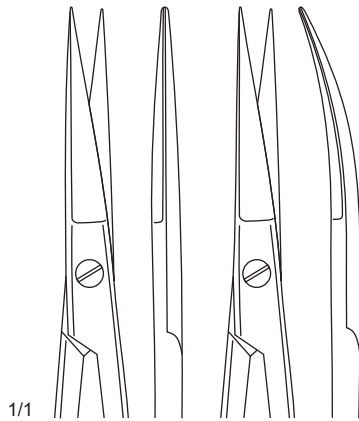

02-133-16  
16 cm / 6 1/2"  
Str.

02-134-16  
16 cm / 6 1/2"  
Cvd.



**Baby Metzenbaum SC**  
02-135-11 - 02-136-11  
11,5 cm / 4 1/2"

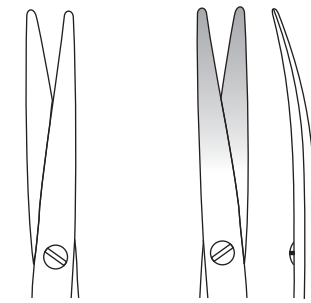

02-135-11  
Str.

02-136-11  
Cvd.

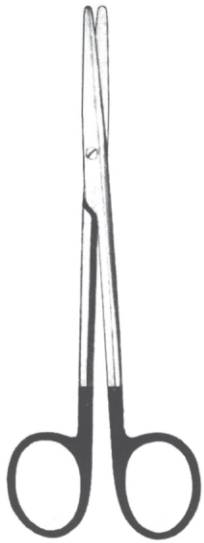

**Metzenbaum SC**  
02-137-14 - 02-142-14

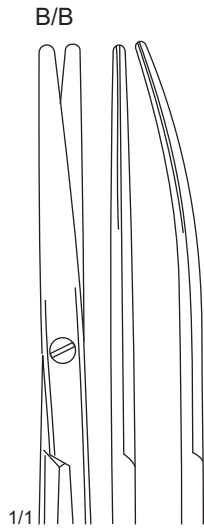

- |           |             |     |
|-----------|-------------|-----|
| 02-137-14 | 14 cm / 5½" | str |
| 02-138-14 | 14 cm / 5½" | cvd |
| 02-137-15 | 15 cm / 6"  | str |
| 02-138-15 | 15 cm / 6"  | cvd |
| 02-137-18 | 18 cm / 7"  | str |
| 02-138-18 | 18 cm / 7"  | cvd |
| 02-137-20 | 20 cm / 8"  | str |
| 02-138-20 | 20 cm / 8"  | cvd |
| 02-137-23 | 23 cm / 9"  | str |
| 02-138-23 | 23 cm / 9"  | cvd |
| 02-137-25 | 25 cm / 10" | str |
| 02-138-25 | 25 cm / 10" | cvd |
| 02-137-28 | 28 cm / 11" | str |
| 02-138-28 | 28 cm / 11" | cvd |
| 02-137-30 | 30 cm / 12" | str |
| 02-138-30 | 30 cm / 12" | cvd |



- |           |             |     |
|-----------|-------------|-----|
| 02-139-14 | 14 cm / 5½" | str |
| 02-140-14 | 14 cm / 5½" | cvd |
| 02-139-15 | 15 cm / 6"  | str |
| 02-140-15 | 15 cm / 6"  | cvd |
| 02-139-18 | 18 cm / 7"  | str |
| 02-140-18 | 18 cm / 7"  | cvd |
| 02-139-20 | 20 cm / 8"  | str |
| 02-140-20 | 20 cm / 8"  | cvd |
| 02-139-23 | 23 cm / 9"  | str |
| 02-140-23 | 23 cm / 9"  | cvd |
| 02-139-25 | 25 cm / 10" | str |
| 02-140-25 | 25 cm / 10" | cvd |
| 02-139-28 | 28 cm / 11" | str |
| 02-140-28 | 28 cm / 11" | cvd |
| 02-139-30 | 30 cm / 12" | str |
| 02-140-30 | 30 cm / 12" | cvd |

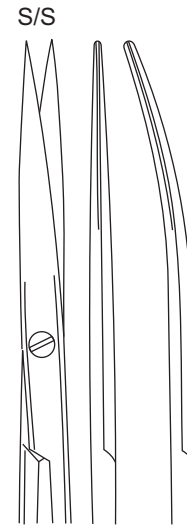

- |           |             |     |
|-----------|-------------|-----|
| 02-141-14 | 14 cm / 5½" | str |
| 02-142-14 | 14 cm / 5½" | cvd |
| 02-141-15 | 15 cm / 6"  | str |
| 02-142-15 | 15 cm / 6"  | cvd |
| 02-141-18 | 18 cm / 7"  | str |
| 02-142-18 | 18 cm / 7"  | cvd |
| 02-141-20 | 20 cm / 8"  | str |
| 02-142-20 | 20 cm / 8"  | cvd |
| 02-141-23 | 23 cm / 9"  | str |
| 02-142-23 | 23 cm / 9"  | cvd |
| 02-141-25 | 25 cm / 10" | str |
| 02-142-25 | 25 cm / 10" | cvd |
| 02-141-28 | 28 cm / 11" | str |
| 02-142-28 | 28 cm / 11" | cvd |
| 02-141-30 | 30 cm / 12" | str |
| 02-142-30 | 30 cm / 12" | cvd |



**Gorney SC**  
02-143-12 - 02-144-19



02-143-12  
12,5 cm / 5"



02-143-19  
19,5 cm / 7¾"



02-144-19  
19,5 cm / 7¾"



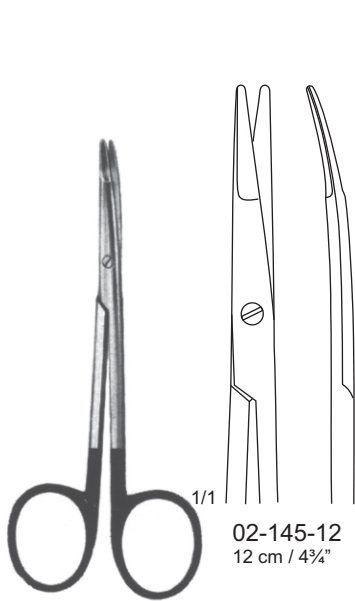

02-145-12  
12 cm / 4¾"

**Kilner SC**  
02-145-12 - 02-046-18

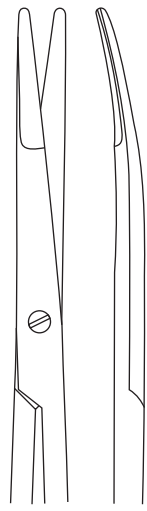

02-146-15  
15 cm / 6"

**Cottle SC**  
02-150-16  
16 cm / 6½"

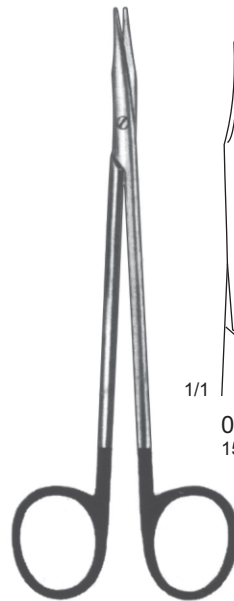

1/1  
02-147-15  
15 cm / 6"

**Reynolds SC**  
02-147-15 - 02-148-18

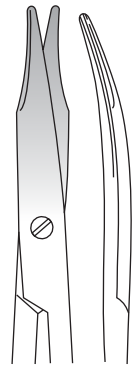

02-148-15  
15 cm / 6"

**Heymann SC**  
02-151-18  
18 cm / 7"



**Fomon SC**  
02-149-15  
15 cm / 6"

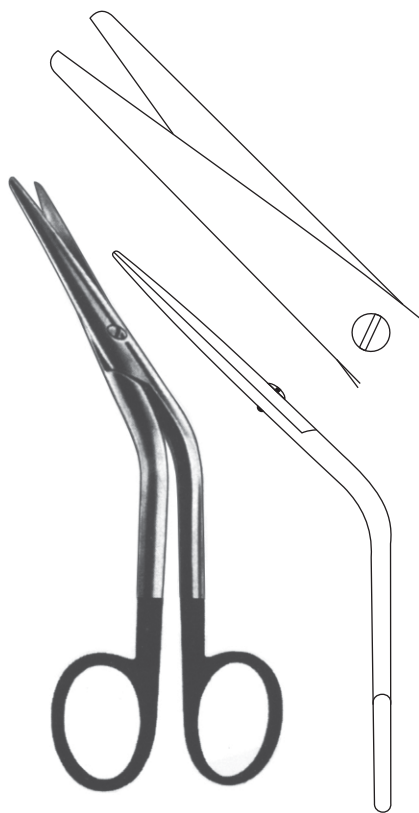

**Cottle SC**  
02-150-16  
16 cm / 6½"

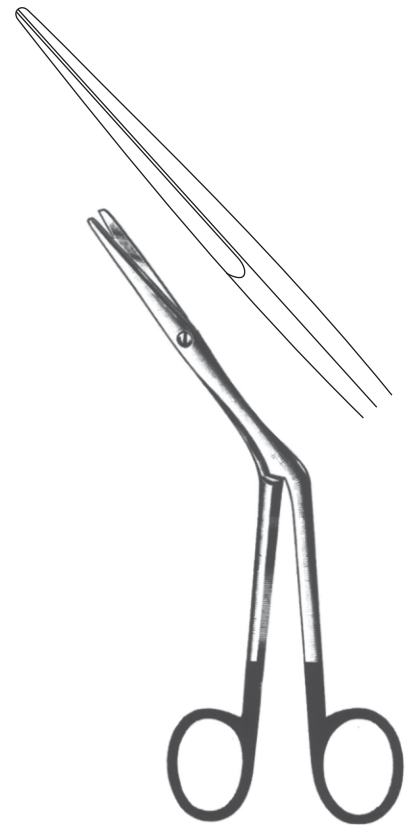

**Heymann SC**  
02-151-18  
18 cm / 7"



**Iris SC**  
02-152-09 - 02-153-10

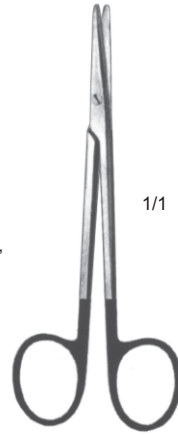
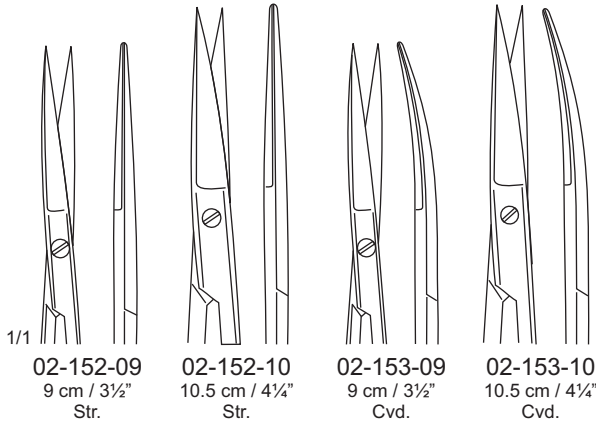

**Strabismus SC**  
02-154-11 - 02-155-11  
11.5 cm / 4 1/2"

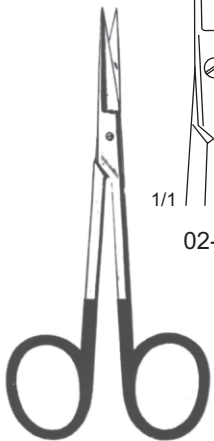
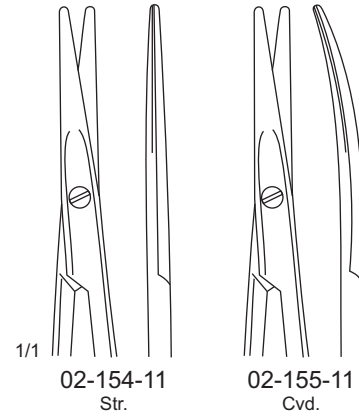

**Iris SC**  
02-156-11 - 02-159-11  
11.5 cm / 4 1/2"

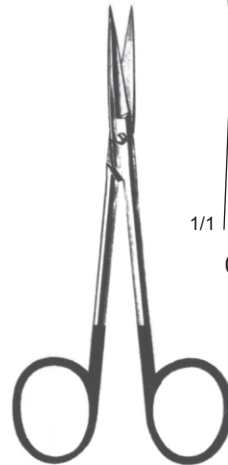

**Wagner SC**  
02-160-12 - 02-161-12  
12 cm / 4 3/4"

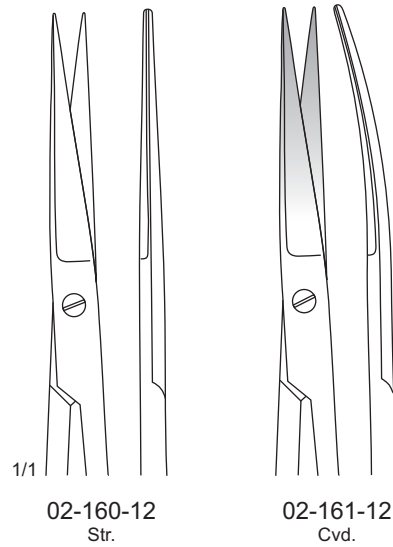

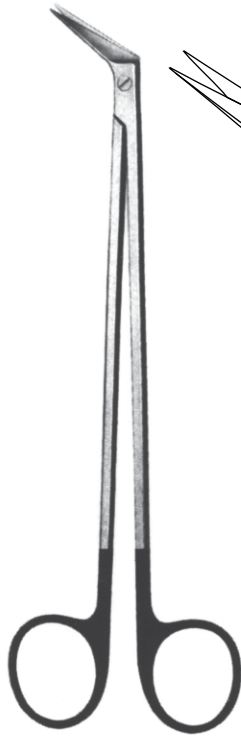

**Potts-Smith SC**  
02-162-19 - 02-164-19  
19 cm / 7½"

1/1  
02-162-19  
19 cm / 7½"

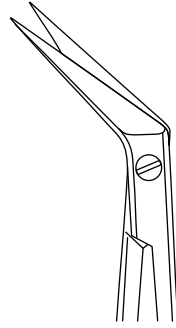

02-163-19  
19 cm / 7½"

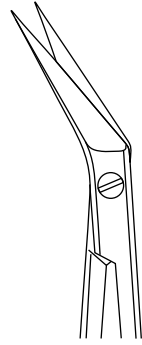

02-164-19  
19 cm / 7½"

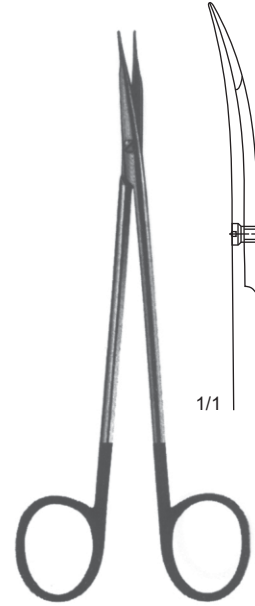

**Jameson SC**  
02-165-15  
15 cm / 6"

1/1

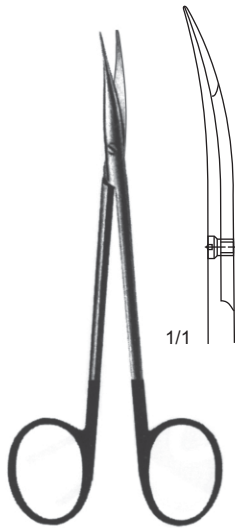

**Jameson**  
02-166-13  
13 cm / 5"

1/1

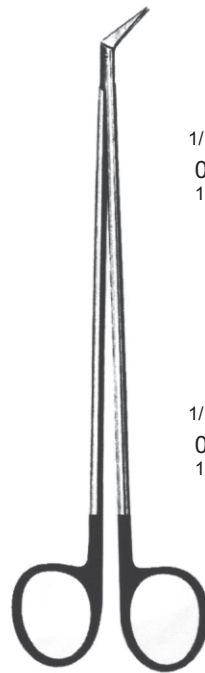

**Dietrich SC**  
02-167-25 - 02-168-00



1/1  
02-167-25  
18 cm / 7"

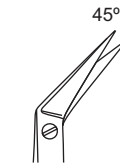

02-167-45  
18 cm / 7"

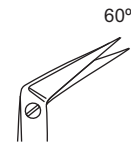

02-167-60  
17,5 cm / 7"

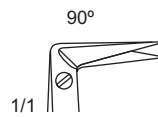

1/1  
02-167-90  
17 cm / 6¾"

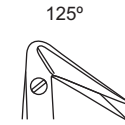

02-168-00  
17 cm / 6¾"

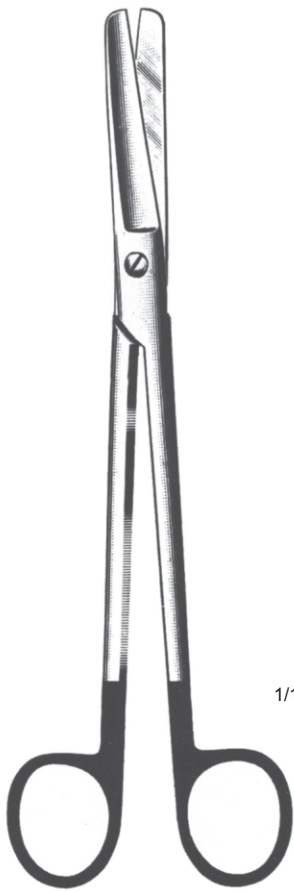

**Sims SC**  
02-169-20 - 02-170-23

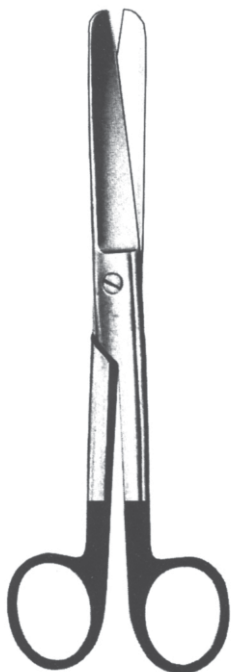
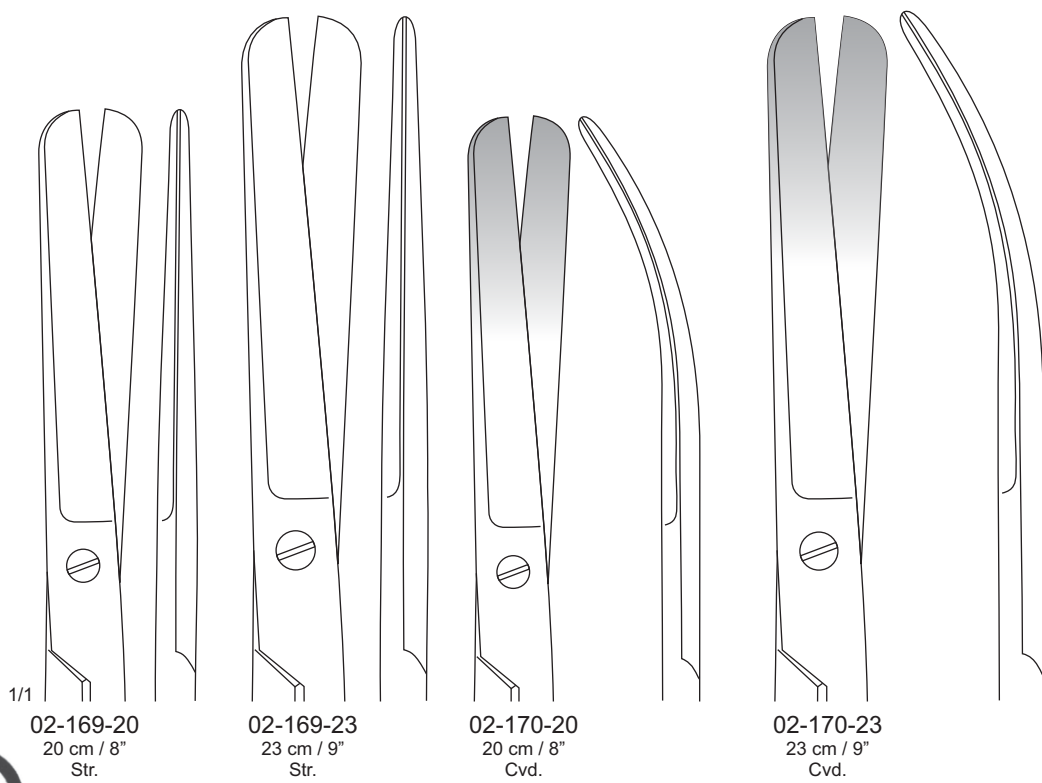

**Braun-Standler TC**  
02-117-14  
14.5 cm / 5½"

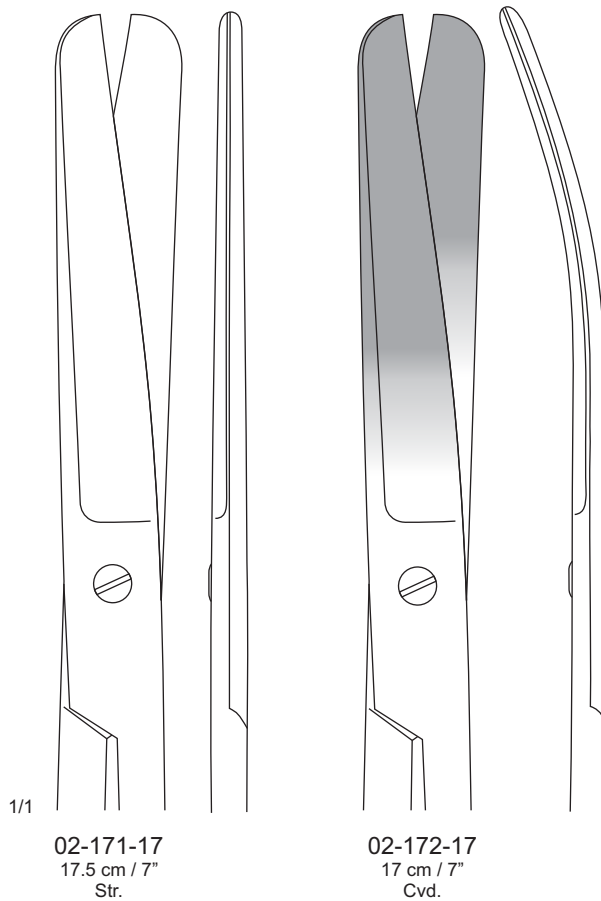

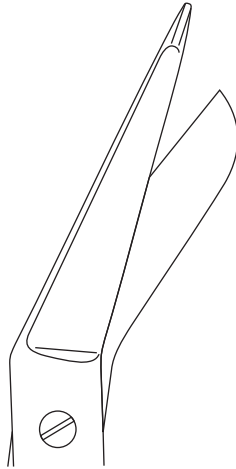

**Lister SC**  
02-173-09 09 cm / 3½"  
02-173-14 14 cm / 5½"  
02-173-18 18 cm / 7"  
02-173-20 20 cm / 8"

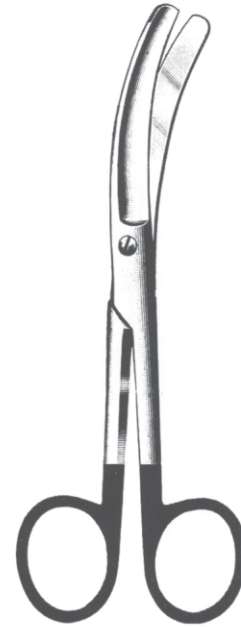

**Busch SC**  
02-174-16  
16 cm / 6¼"

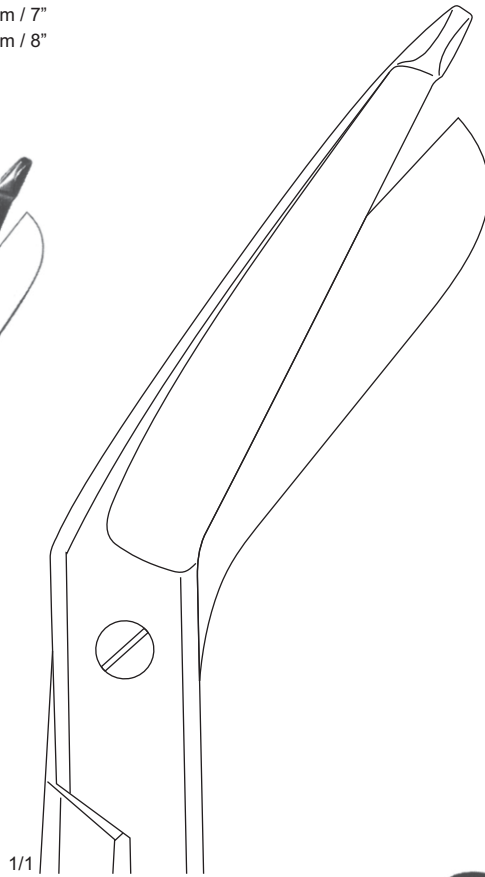
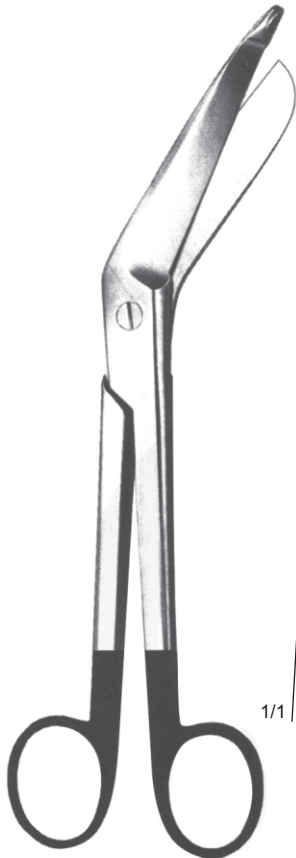

**Bergmann SC**  
02-175-23  
23 cm / 9"

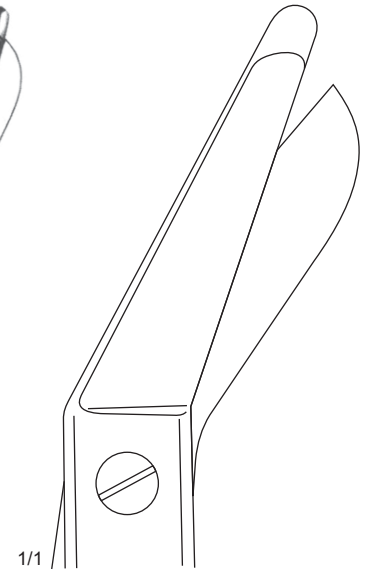
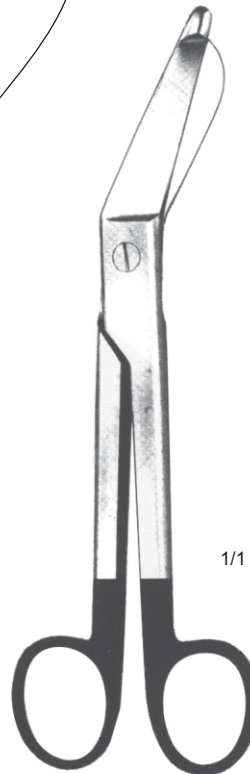

**Esmarch SC**  
02-176-20 20 cm / 8"  
02-176-22 22 cm / 8¾"





[www.krnano.com](http://www.krnano.com)

조직 및 혈관포셉

**FORCEPS & CLAMPS**

Page 049 - 075

### 검사 및 분류(변형제품 제거)

오염 제거 및 세척 후 검사를 시행합니다.  
이 검사 과정은 팁 파손, 정렬 불량, 부식 및  
구부러짐 등 제품의 변형을 주로 확인해야 합  
니다.

사용 목적에 부합된 제품은 교체해야 합니다.  
긴박한 수술 도중 사용 목적과 부합된 목적으  
로 사용할 경우 기기의 성능이 저하될 수 있습  
니다.이럴 경우, 설계된 대로 작동하지 않으면  
교체해야 합니다.

### 검사준비 및 세척

세척을 위해 기구를 준비할 때 섬세하게 뚜껍  
으로 보호하십시오.

세척 중 기구의 열린 위치, 날카로운 포인트  
는 서로 닿아서는 안 되며,  
사용 후 세척을 준비할 때, 의료기구를 배치  
하는 것이 중요합니다.

필요한 경우 수건을 바닥에 깔고 의료기를 놓  
고 분리하면 의료기 상호 간에 마찰을 최소화  
할 수 있어서 밀부분을 보호할 수 있습니다.

KGMP에서 요구하는 의료기 관리지침을  
준수하십시오



2페이지의 재사용 의료기구의 관리를 참조하십시오

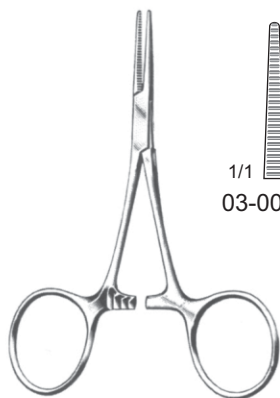

**Hartmann**  
03-001-10 - 03-002-10  
10 cm / 4"

1/1  
03-001-10

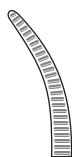

03-002-10

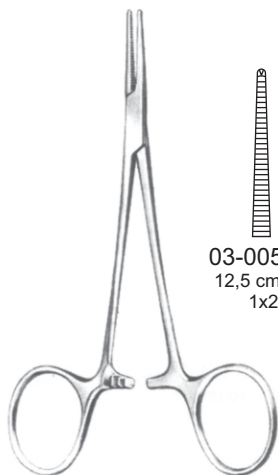

**Halsted-Mosquito**  
03-003-12 - 03-006-14

1/1  
03-003-12  
12,5 cm / 5"

03-003-14  
14 cm / 5½"

03-004-12  
12,5 cm / 5"

03-004-14  
14 cm / 5½"

03-005-12  
12,5 cm / 5"  
1x2

03-005-14  
14 cm / 5½"  
1x2

03-006-12  
12,5 cm / 5"  
1x2

03-006-14  
14 cm / 5½"  
1x2

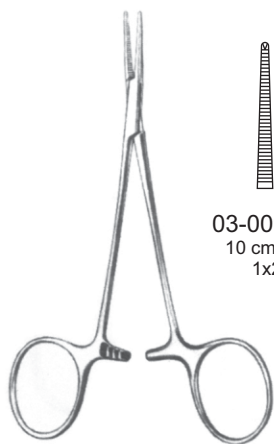

**Micro-Mosquito**  
03-007-10 - 03-010-12

1/1  
03-007-10  
10 cm / 4"

03-007-12  
12 cm / 4¾"

03-008-10  
10 cm / 4"

03-008-12  
12 cm / 4¾"

03-009-10  
10 cm / 4"  
1x2

03-009-12  
12 cm / 4¾"  
1x2

03-010-10  
10 cm / 4"  
1x2

03-010-12  
12 cm / 4¾"  
1x2

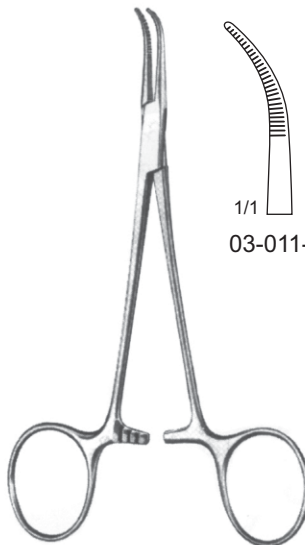

**Baby-Mixer**  
03-011-01 - 03-011-02  
14 cm / 5½"

1/1  
03-011-01

03-011-02





**Kelly**  
03-012-14 - 03-015-16

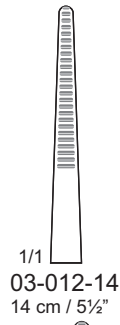

1/1  
03-012-14  
14 cm / 5½"

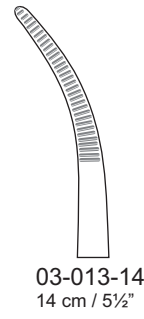

03-013-14  
14 cm / 5½"

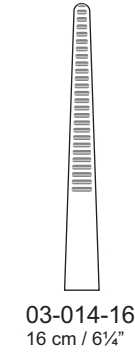

03-014-16  
16 cm / 6¼"

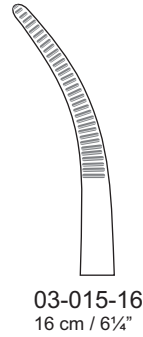

03-015-16  
16 cm / 6¼"

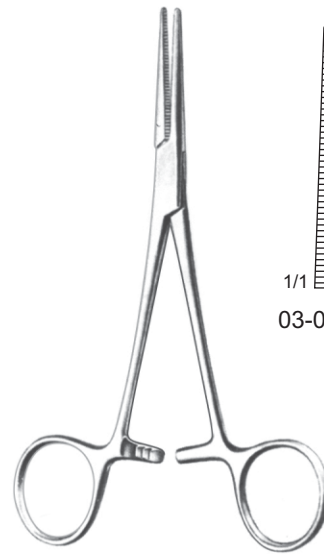

**Crile**  
03-016-64 - 03-017-64  
14 cm / 5½"

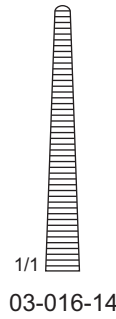

1/1  
03-016-14

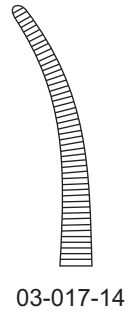

03-017-14



**Crile-Rankin**  
03-018-16 - 03-019-16  
16 cm / 6¼"

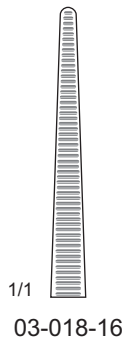

1/1  
03-018-16

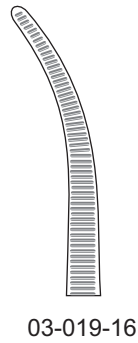

03-019-16

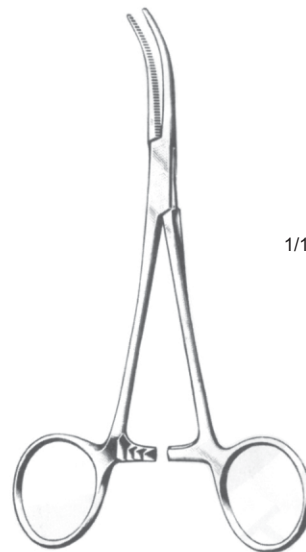

**Dandy**  
03-020-16 - 03-021-16

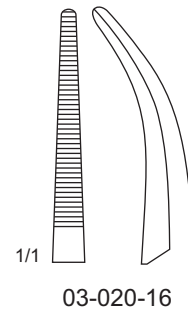

1/1  
03-020-16

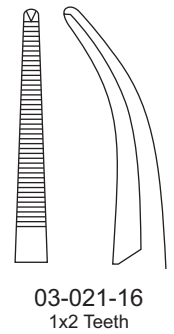

03-021-16  
1x2 Teeth



Rochester Carmalt  
03-022-16 - 03-023-20

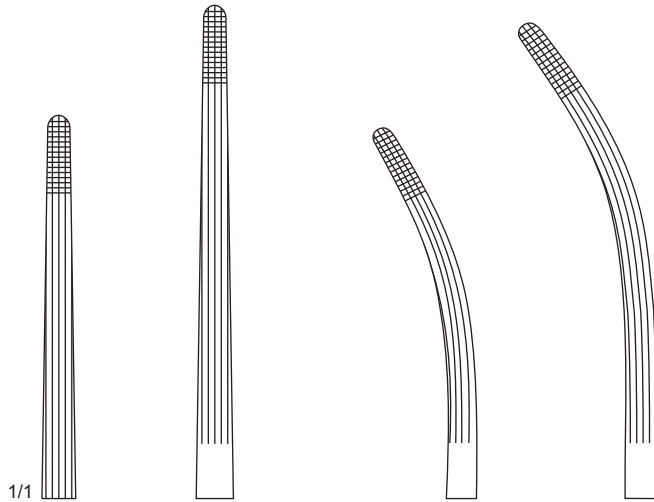

03-022-16  
16 cm / 6¼"

03-022-20  
20 cm / 8"

03-023-16  
16 cm / 6¼"

03-023-20  
20 cm / 8"



Schnidt  
03-024-18 - 03-024-19

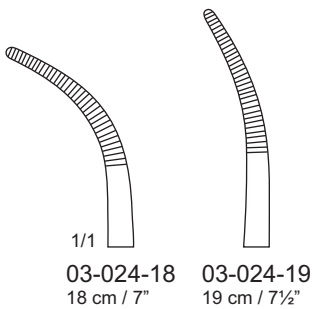

03-024-18  
18 cm / 7"

03-024-19  
19 cm / 7½"

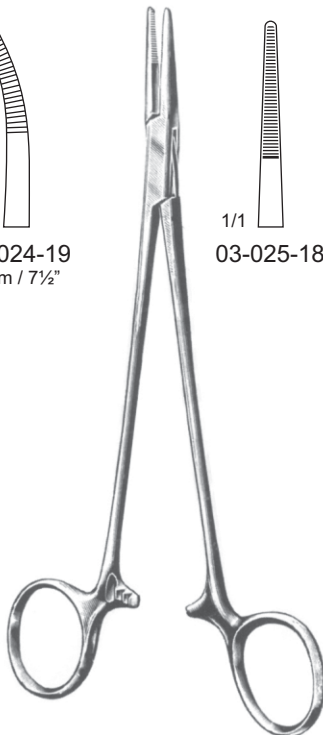

Adson  
03-025-18 - 03-026-18  
18,5 cm / 7¼"

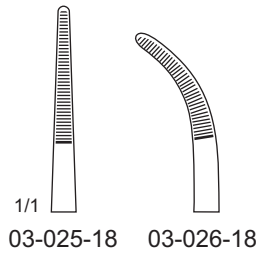

03-025-18

03-026-18

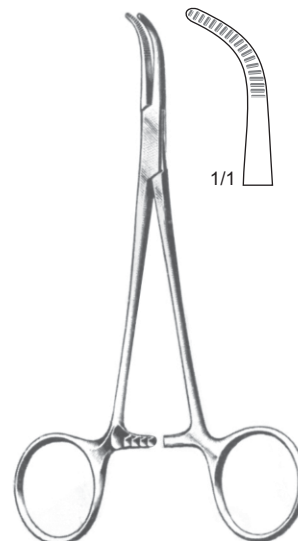

Mixer Baby  
03-027-14  
14 cm / 5½"



1/1





Péan (Delicate)  
03-028-13 - 03-029-16

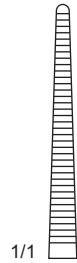

1/1  
03-028-13  
16 cm / 5"



03-028-14  
14 cm / 5½"



03-028-16  
16 cm / 6¼"



03-029-13  
13 cm / 5"



03-029-14  
14 cm / 5½"

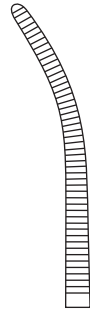

03-029-16  
16 cm / 6¼"



Péan  
03-030-13 - 03-031-16



1/1  
03-030-13  
16 cm / 5"



03-030-14  
14 cm / 5½"



03-030-16  
16 cm / 6¼"



03-031-13  
13 cm / 5"



03-031-14  
14 cm / 5½"

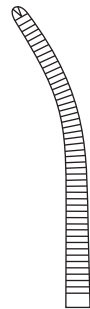

03-031-16  
16 cm / 6¼"

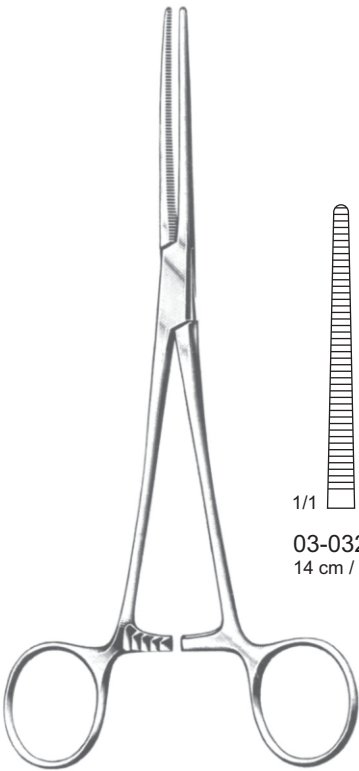

Péan (Rochester)  
03-032-14 - 03-033-30

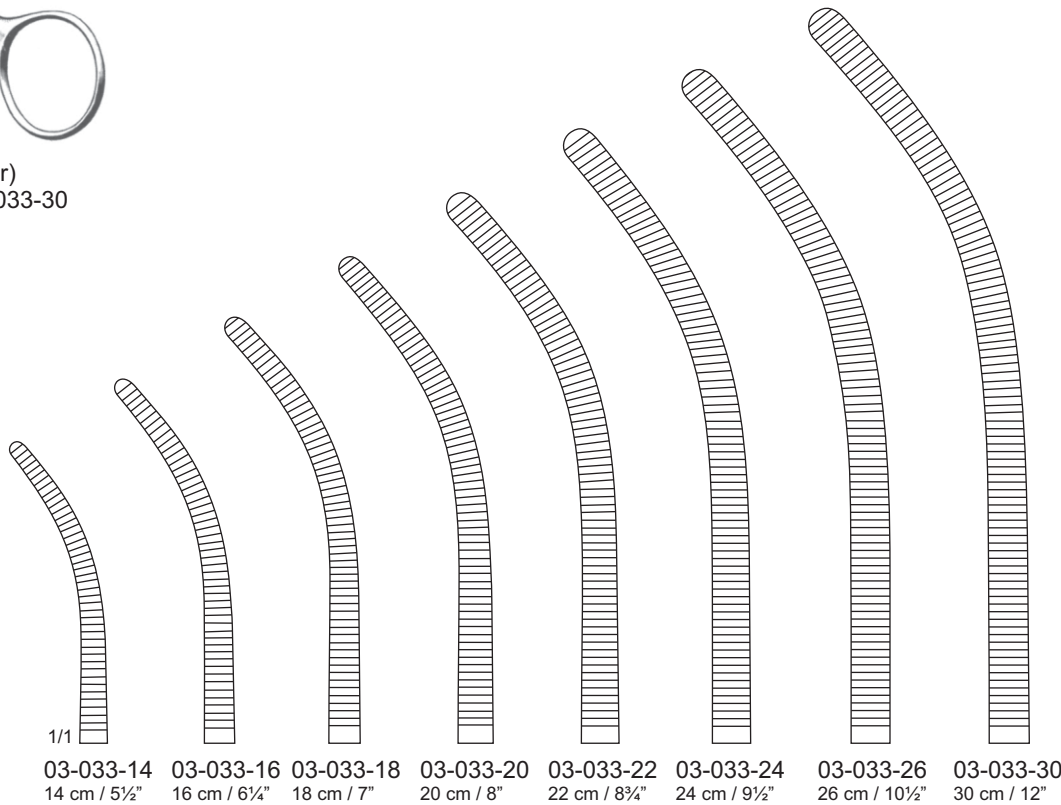
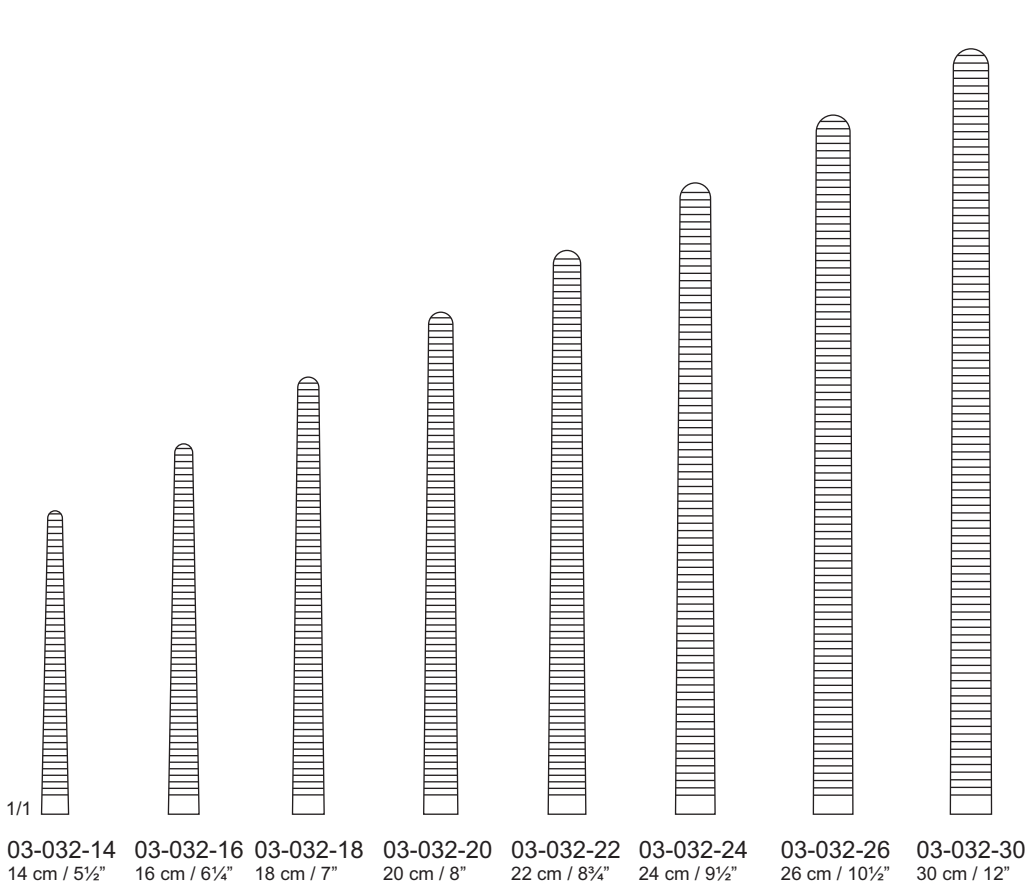

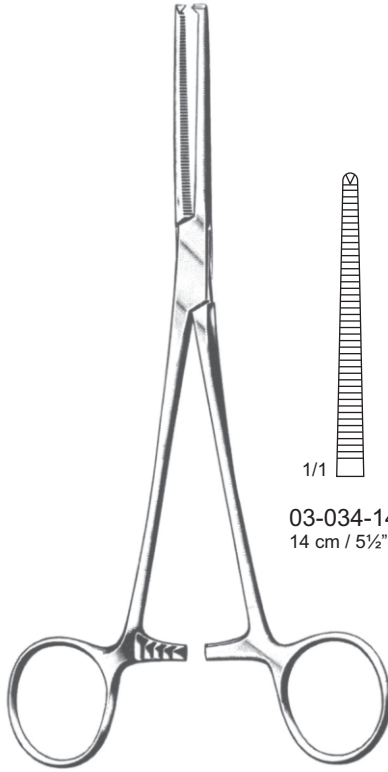

Kocher (Ochsner)  
03-034-14 - 03-035-30

1/1

- 03-034-14  
14 cm / 5½"
- 03-034-16  
16 cm / 6¼"
- 03-034-18  
18 cm / 7"
- 03-034-20  
20 cm / 8"
- 03-034-22  
22 cm / 8¾"
- 03-034-24  
24 cm / 9½"
- 03-034-26  
26 cm / 10½"
- 03-034-30  
30 cm / 12"

1/1

- 03-035-14  
14 cm / 5½"
- 03-035-16  
16 cm / 6¼"
- 03-035-18  
18 cm / 7"
- 03-035-20  
20 cm / 8"
- 03-035-22  
22 cm / 8¾"
- 03-035-24  
24 cm / 9½"
- 03-035-26  
26 cm / 10½"
- 03-035-30  
30 cm / 12"



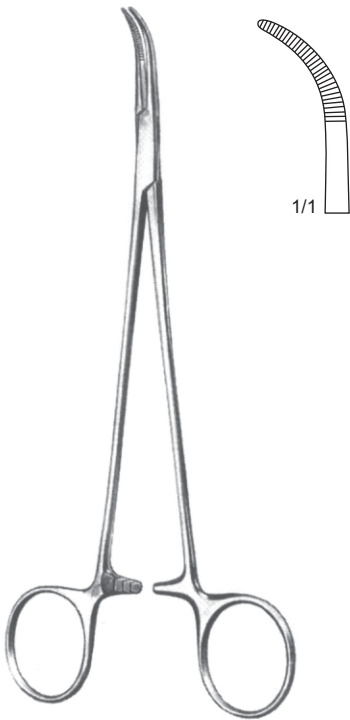

**Baby-Mixer**  
03-036-18  
18 cm / 7"



**Baby-Adson**  
03-037-14 - 03-038-18

03-037-14  
14 cm / 5½"

03-038-18  
18 cm / 7"

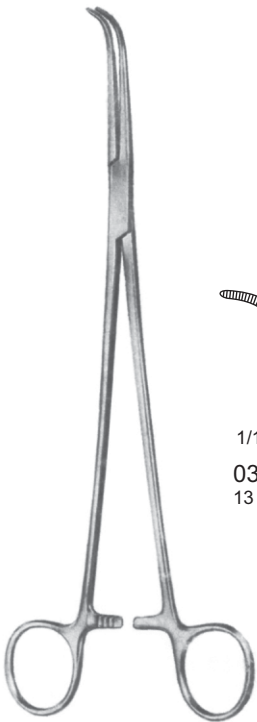

**Gemini**  
03-039-18 - 03-039-28

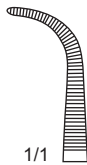

03-039-13  
13 cm / 5"

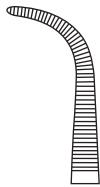

03-039-16  
16 cm / 6¼"

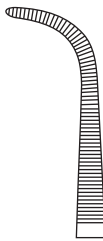

03-039-18  
18 cm / 7"

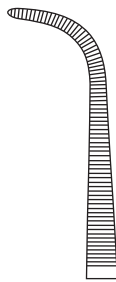

03-039-20  
20 cm / 8"

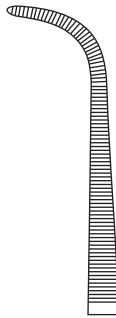

03-039-23  
23 cm / 9"



03-039-25  
25 cm / 10"



03-039-28  
28 cm / 11"





Mixer  
03-040-22 - 03-042-28

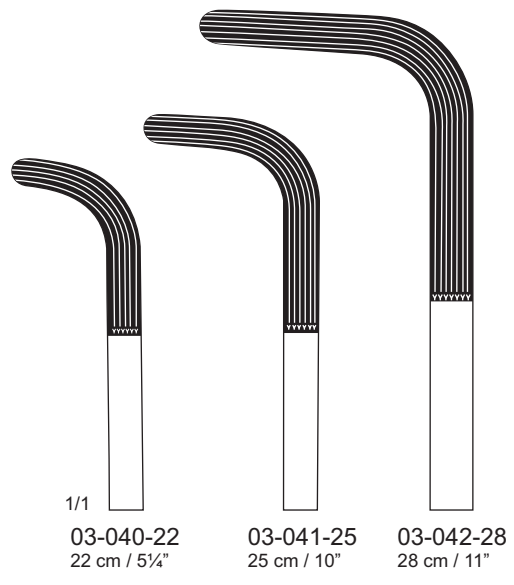

1/1  
03-040-22 22 cm / 5 1/4"  
03-041-25 25 cm / 10"  
03-042-28 28 cm / 11"



Lahey  
03-043-19 - 03-044-23

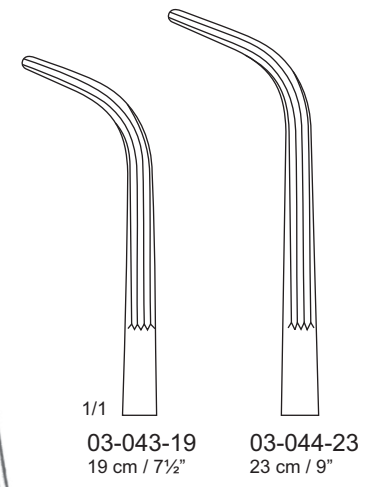

1/1  
03-043-19 19 cm / 7 1/2"  
03-044-23 23 cm / 9"



Heaney  
03-045-19 - 03-046-23

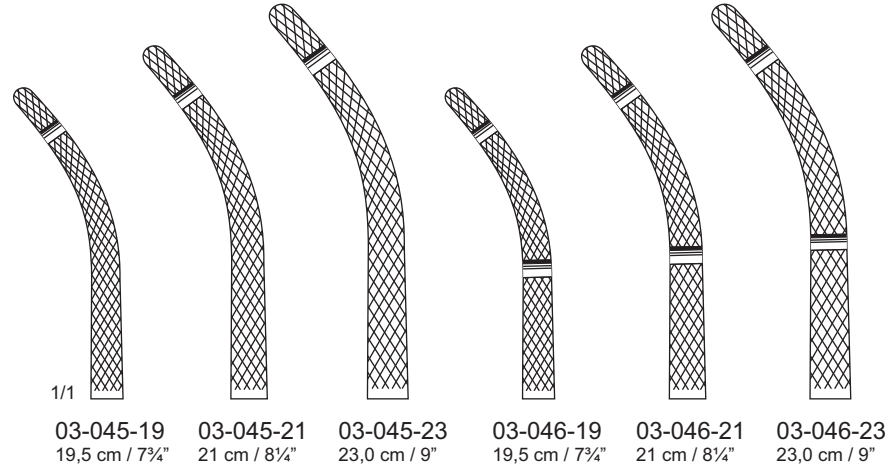

1/1  
03-045-19 19,5 cm / 7 3/4"  
03-045-21 21 cm / 8 1/4"  
03-045-23 23,0 cm / 9"  
03-046-19 19,5 cm / 7 3/4"  
03-046-21 21 cm / 8 1/4"  
03-046-23 23,0 cm / 9"

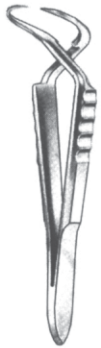

**Jones**  
03-047-05 5 cm / 2"  
03-047-09 9 cm / 3½"



**Backhaus**  
03-048-08 8 cm / 3¼"  
03-048-09 9 cm / 3½"  
03-048-11 11 cm / 4½"  
03-048-13 13 cm / 5"  
03-048-15 15 cm / 6"



**Bernhard**  
03-049-16  
16,5 cm / 6½"

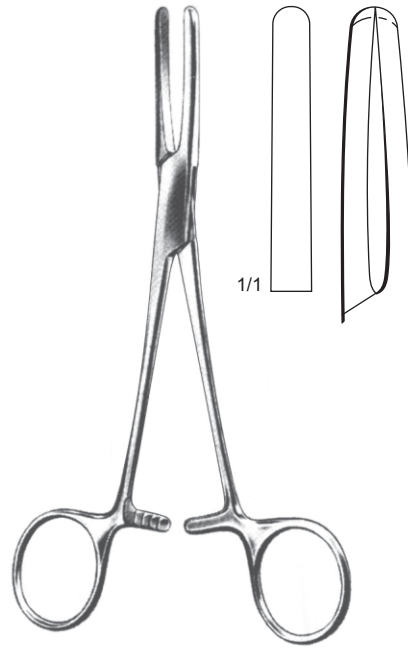

**Tube Clamp**  
03-050-16  
16,5 cm / 6½"



**Standard**  
03-051-15 - 03-051-20



03-051-15  
15 cm / 6"

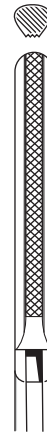

03-051-18  
18 cm / 7"

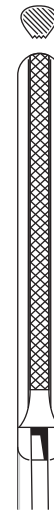

03-051-20  
20 cm / 8"



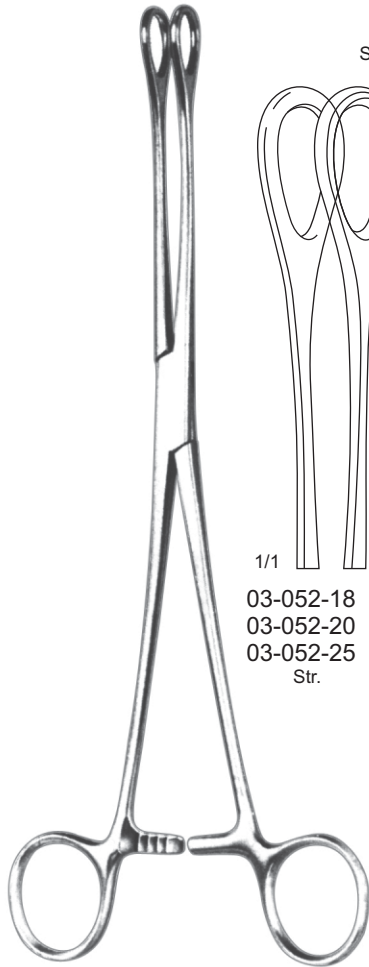

**Foerster**  
03-052-18 - 03-055-25

SMOOTH

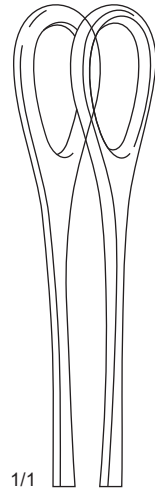

1/1  
03-052-18 18 cm / 7"  
03-052-20 20 cm / 8"  
03-052-25 25 cm / 10"  
Str.

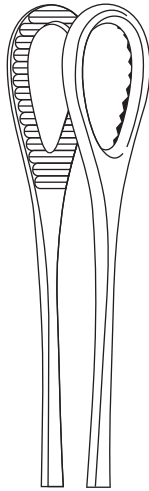

03-053-18 18 cm / 7"  
03-053-20 20 cm / 8"  
03-053-25 25 cm / 10"  
Str.

SMOOTH

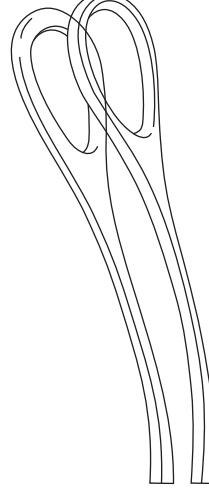

03-054-18 18 cm / 7"  
03-054-20 20 cm / 8"  
03-054-25 25 cm / 10"  
Cvd.

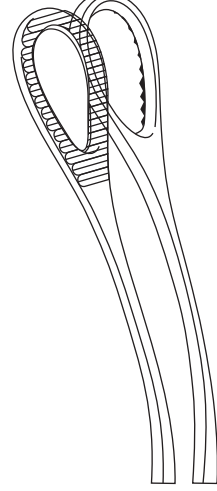

03-055-18 18 cm / 7"  
03-055-20 20 cm / 8"  
03-055-25 25 cm / 10"  
Cvd.



**Staude-Moore**  
03-056-17  
17 cm / 6 3/4"



**Rampley**  
03-057-25  
25 cm / 10"



1/1

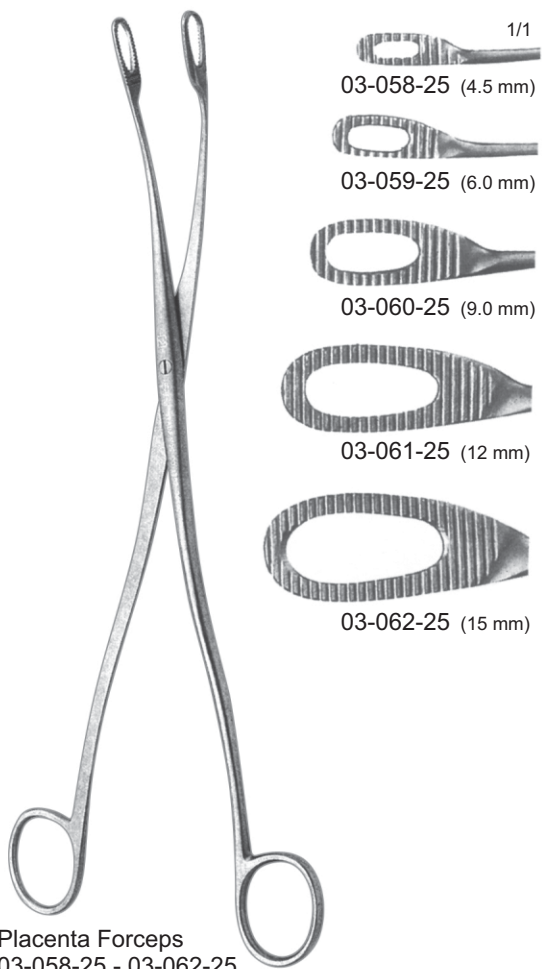

**Placenta Forceps**  
03-058-25 - 03-062-25  
25 cm / 10"

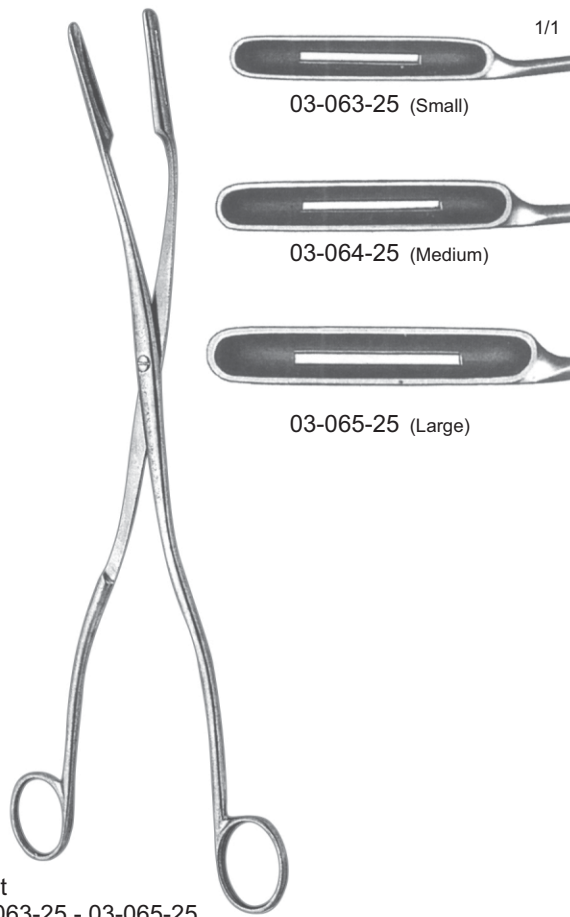

**Hirst**  
03-063-25 - 03-065-25  
25 cm / 10"

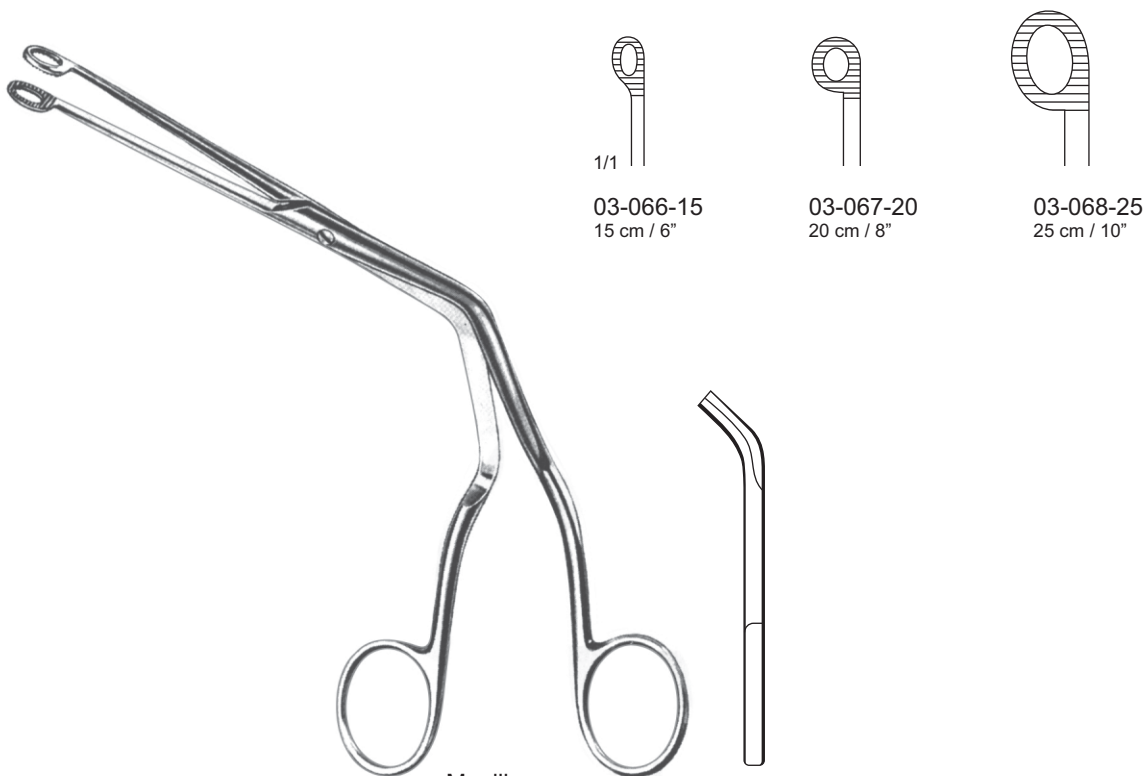

**Magill**  
03-066-15 - 03-068-25



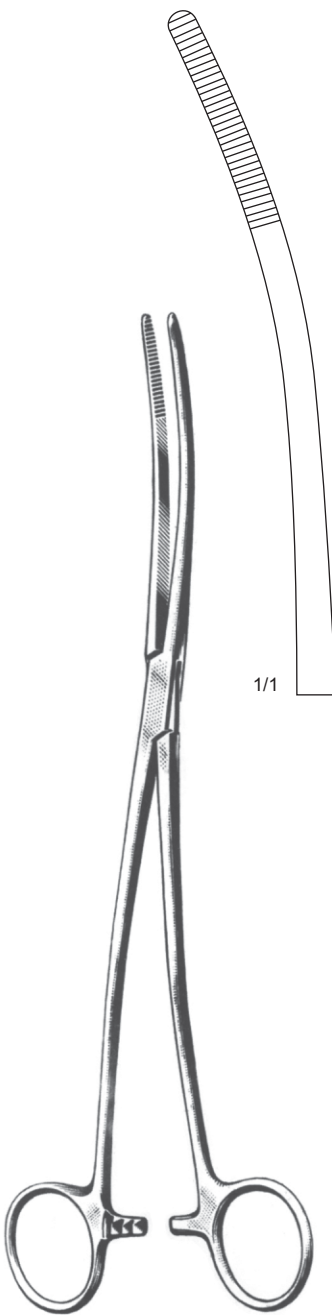

**Bozemann**  
03-069-26  
26 cm / 10¼"

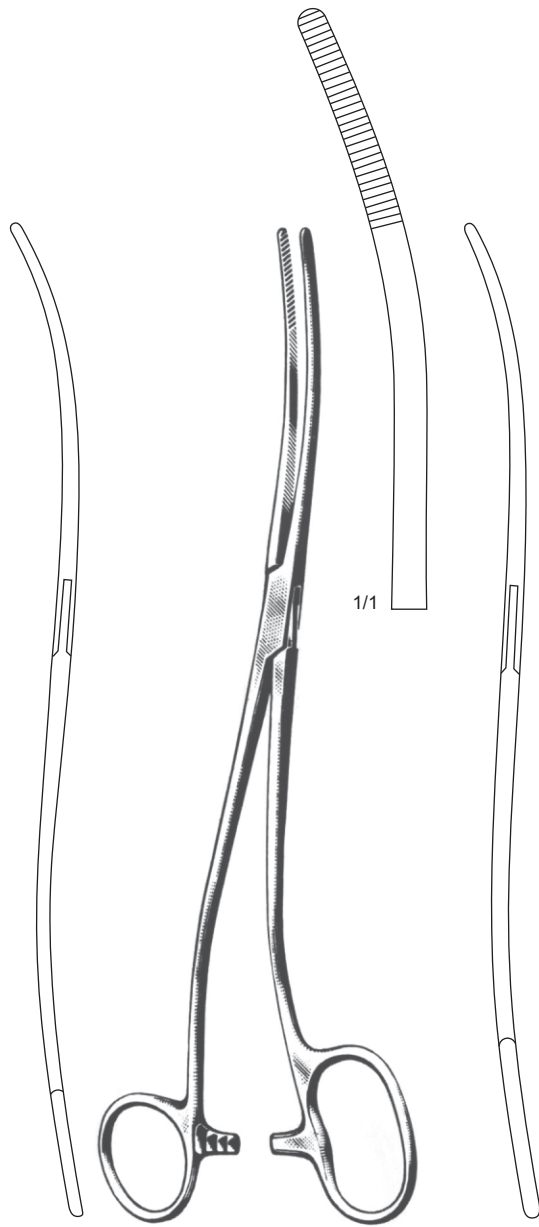

**Bozemann-Douglas**  
03-070-26  
26 cm / 10¼"

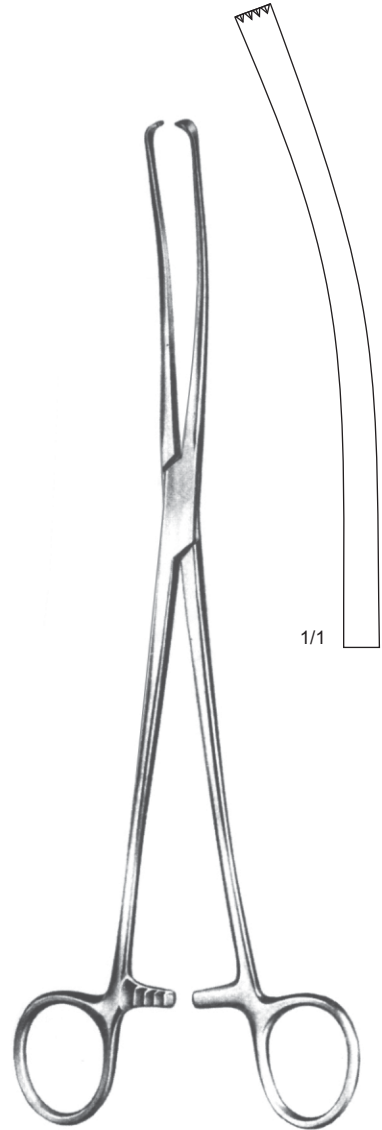

**Lowa**  
03-071-26  
26 cm / 10¼"



**Pozzi**  
03-072-26  
25,5 cm / 10¼"



**Braun**  
03-073-25  
25 cm / 10"



**Schroeder**  
03-074-25  
25 cm / 10"

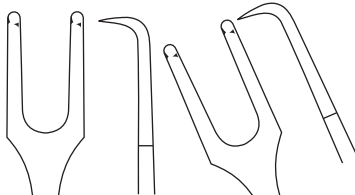

1/1  
03-075-25

1/1  
03-076-25



**Schroeder 2x2 Teeth**  
03-075-25 - 03-076-24  
24 cm / 9½"



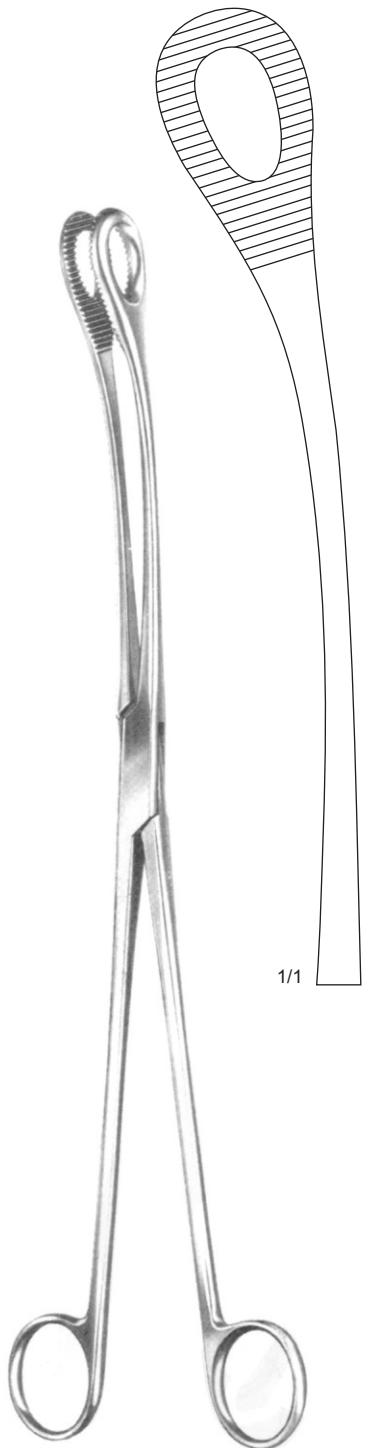

**Kelly**  
03-077-32  
32 cm / 12½"

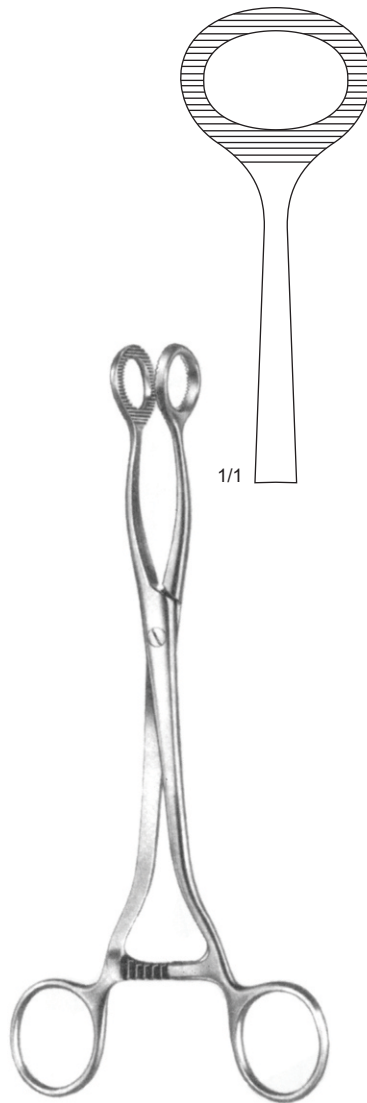

**Doyen**  
03-078-20  
20 cm / 8"

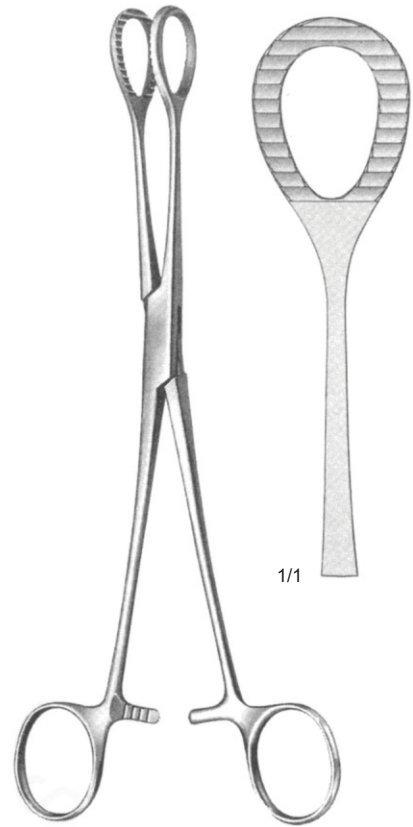

**Heywood**  
03-079-20  
20 cm / 8"



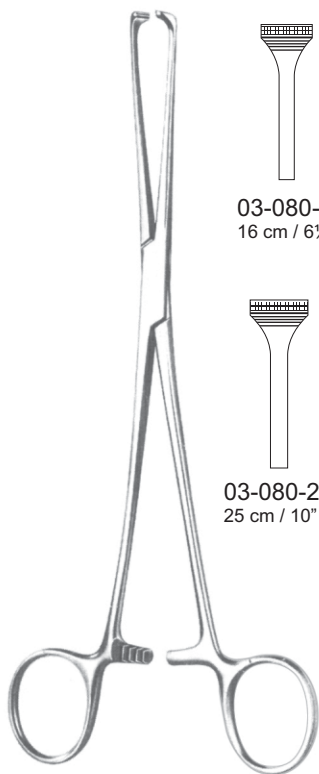

03-080-16  
16 cm / 6 1/4"

03-080-20  
20 cm / 8 1/4"

03-080-25  
25 cm / 10"

03-080-30  
30 cm / 12"

**Allis-DeBakey**  
03-080-16 - 03-080-30

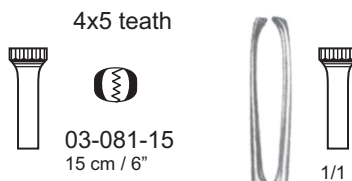

4x5 teeth

03-081-15  
15 cm / 6"

5x6 teeth

03-082-15  
15 cm / 6"

03-082-19  
19 cm / 7 1/2"

03-082-25  
25 cm / 10"

**Allis**  
03-081-15 - 03-082-25

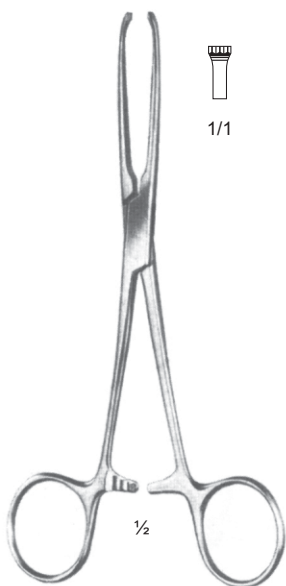

1/1

1/2

**Judd-Allis**  
03-083-15 15 cm / 6"  
03-083-19 19 cm / 7 1/2"

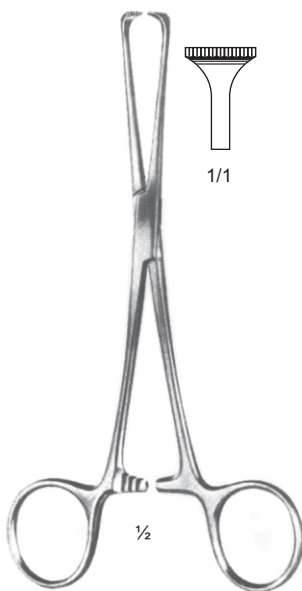

1/1

1/2

**Allis-Adair**  
03-084-15  
15 cm / 6"



1/1

1/2

**Thomas-Allis**  
03-085-20  
20 cm / 8"

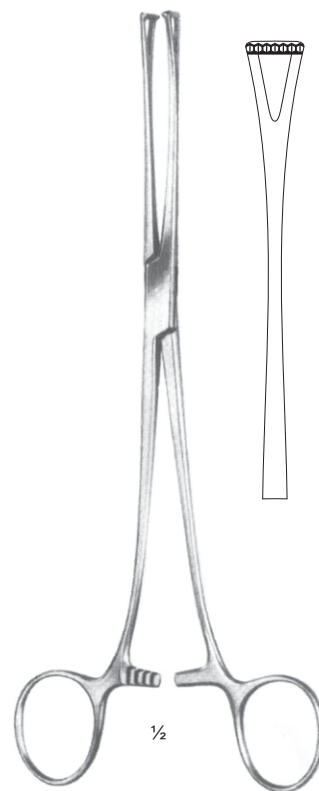

1/2

**Lockwood**  
03-086-20  
20 cm / 8"





Babcock  
03-087-16 - 03-087-24

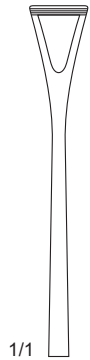

1/1  
03-087-16  
16 cm / 6¼"

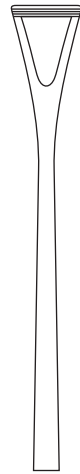

03-087-18  
18 cm / 7"

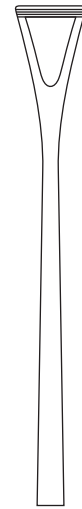

03-087-20  
20 cm / 8"

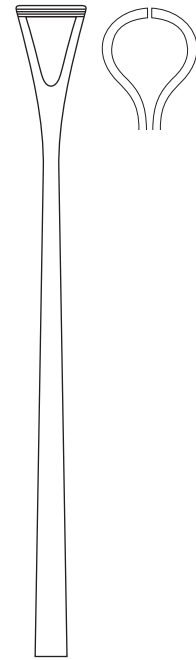

03-087-24  
24 cm / 9½"

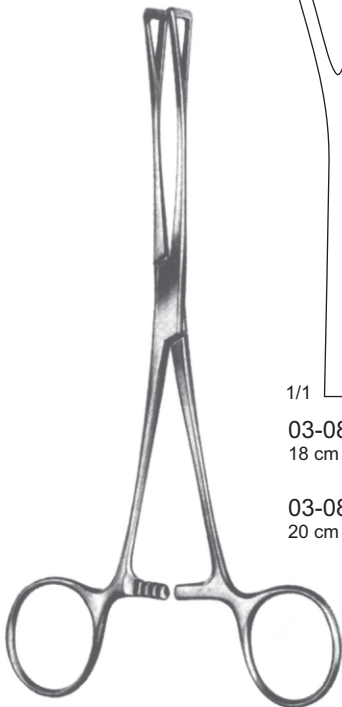

Duval  
03-088-18 - 03-089-23

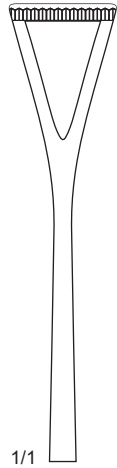

1/1  
03-088-18  
18 cm / 7"

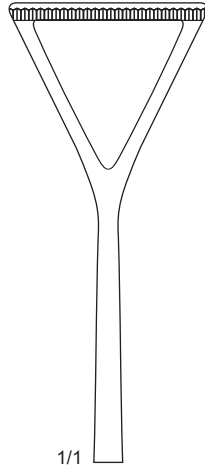

1/1  
03-089-20  
20 cm / 9"

03-088-20  
20 cm / 8"

03-089-23  
23 cm / 9"

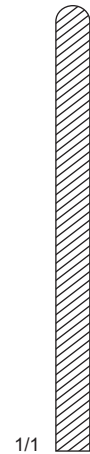

1/1  
03-090-18

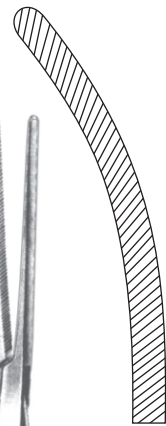

03-091-18

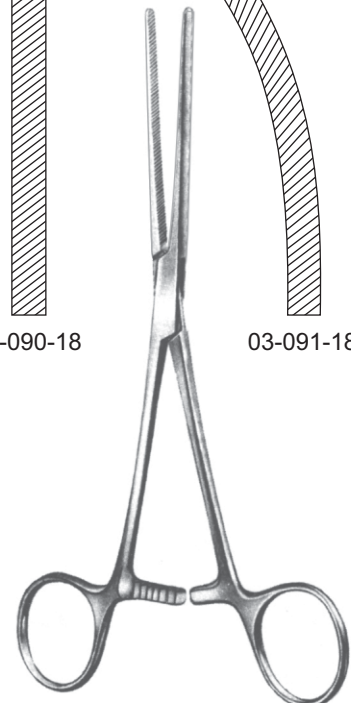

Baby-Doyen  
03-090-18 - 03-091-18  
18 cm / 7"

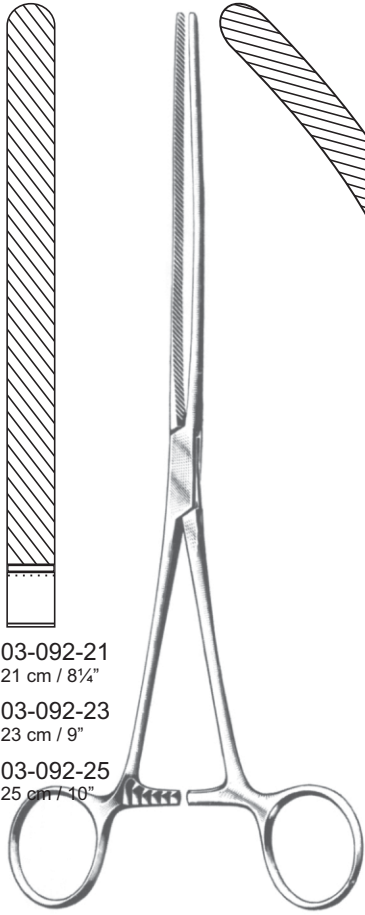

03-092-21  
21 cm / 8¼"  
03-092-23  
23 cm / 9"  
03-092-25  
25 cm / 10"

**Doyen**  
03-092-21 - 03-093-23

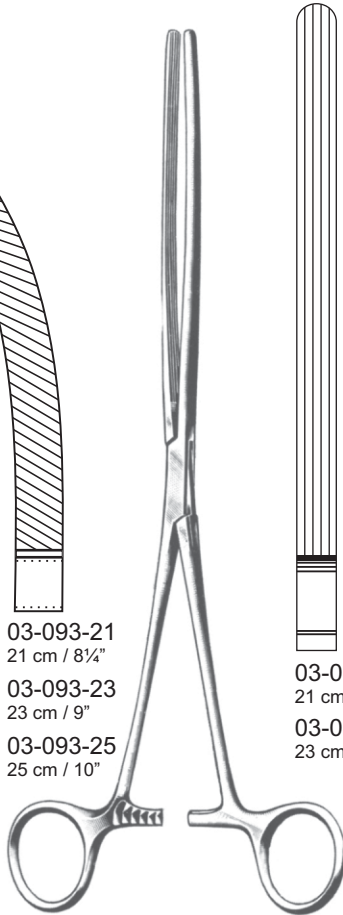

03-093-21  
21 cm / 8¼"  
03-093-23  
23 cm / 9"  
03-093-25  
25 cm / 10"

**Mayo-Robson**  
03-094-21 - 03-095-23

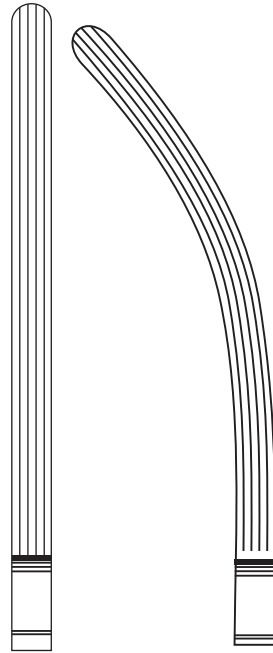

03-094-21  
21 cm / 8¼"  
03-094-23  
23 cm / 9"

03-095-21  
21 cm / 8¼"  
03-095-23  
23 cm / 9"



1/1  
03-096-25

**Mayo-Robson**  
03-096-25 - 03-097-25  
25 cm / 10"

03-097-25



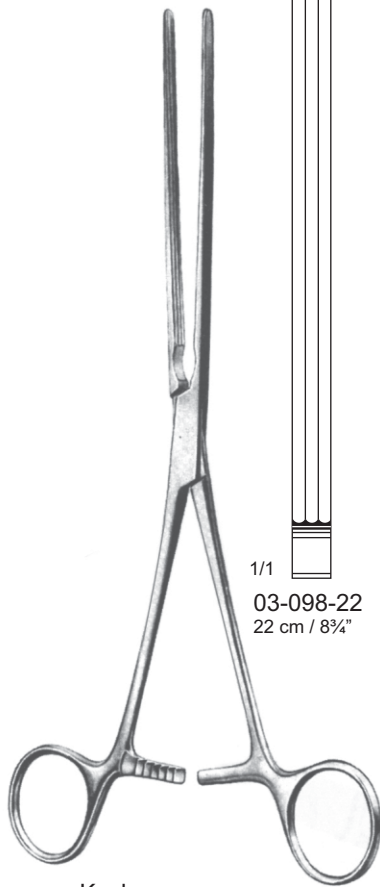

Kocher  
03-098-22 - 03-098-28

1/1

03-098-22  
22 cm / 8 3/4"

03-098-25  
25 cm / 10"

03-098-28  
28 cm / 11"

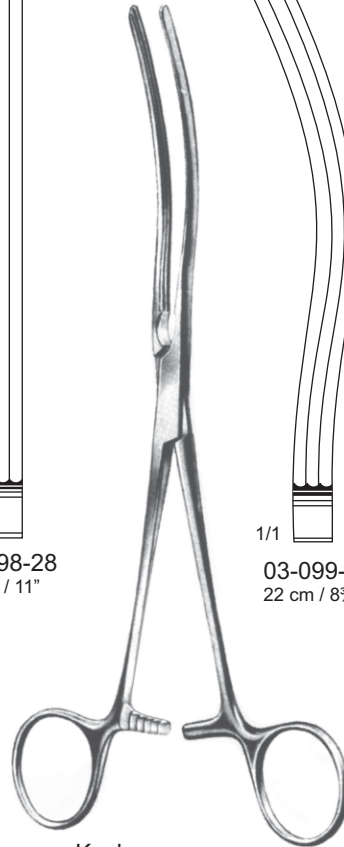

Kocher  
03-099-22 - 03-099-28

1/1

03-099-22  
22 cm / 8 3/4"

03-099-25  
25 cm / 10"

03-099-28  
28 cm / 11"

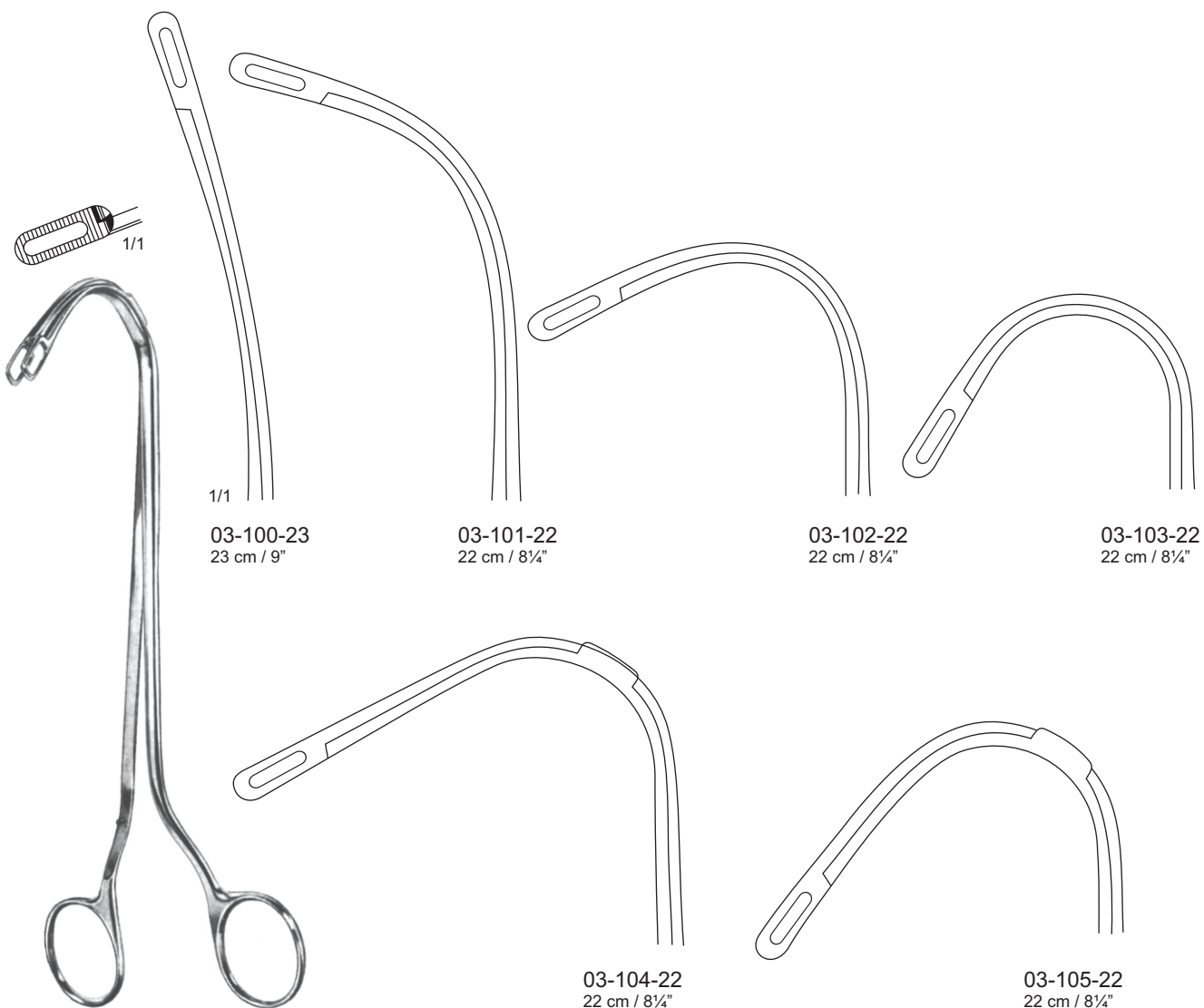
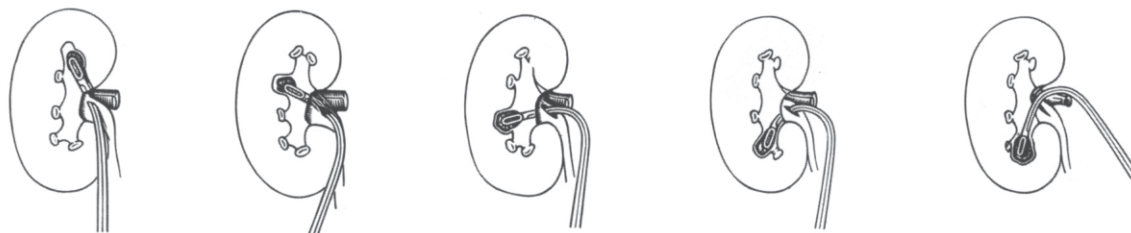

03-100-23  
23 cm / 9"

03-101-22  
22 cm / 8 1/4"

03-102-22  
22 cm / 8 1/4"

03-103-22  
22 cm / 8 1/4"

03-104-22  
22 cm / 8 1/4"

03-105-22  
22 cm / 8 1/4"

Randall  
03-100-23 - 03-105-19



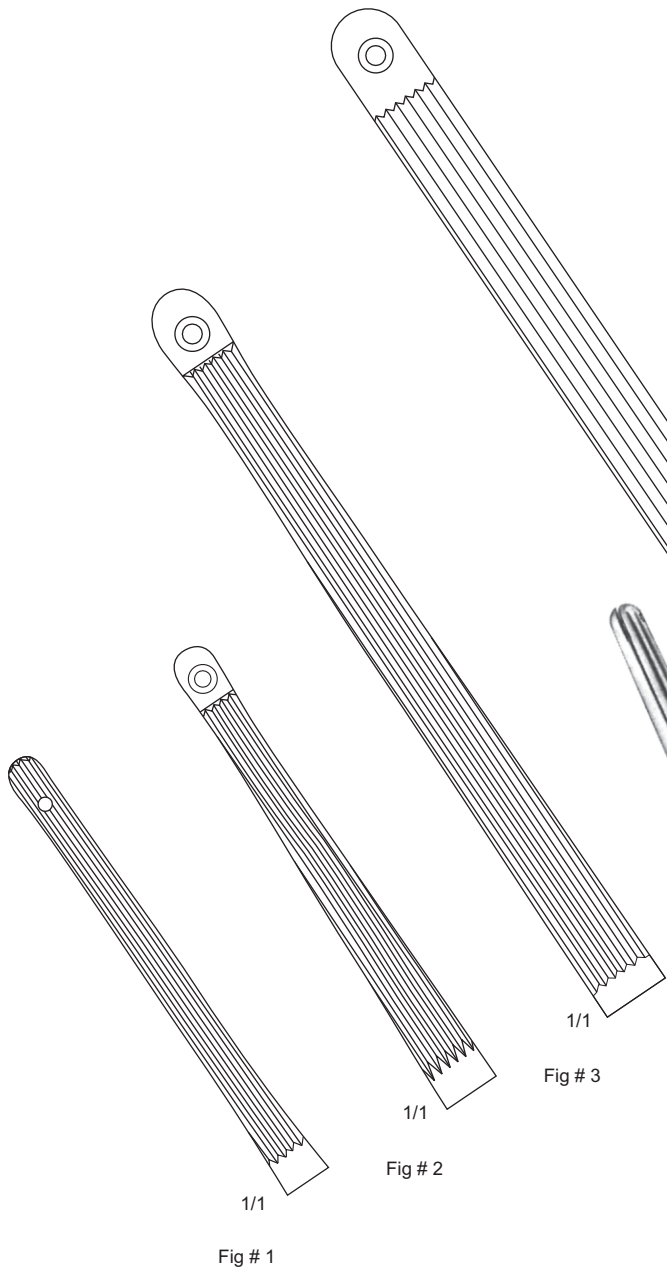

Fig # 1

Fig # 2

Fig # 3

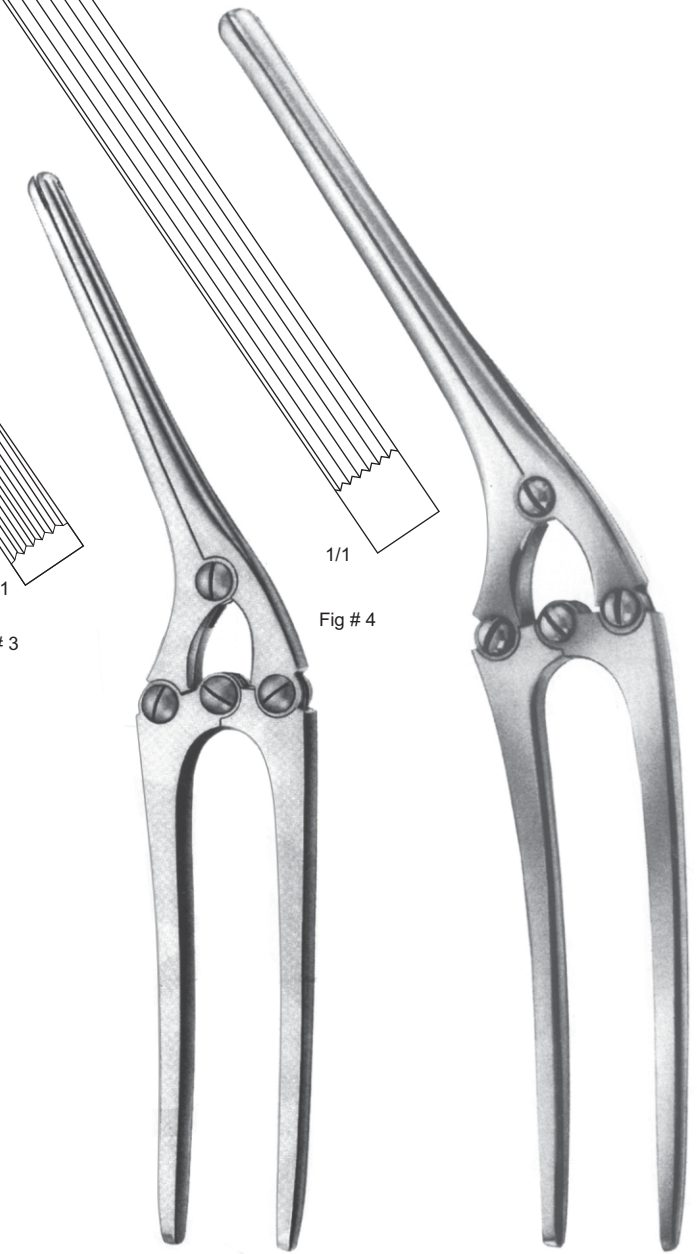

Fig # 4

Payr Intestinal Clamp

Payr Pylorus Intestinal Clamp

- Fig # 1 03-106-18 18 cm / 7"
- Fig # 2 03-106-20 20 cm / 8"
- Fig # 3 03-106-28 28 cm / 10<sup>3</sup>/<sub>4</sub>"

- Fig # 4 03-107-32 32 cm / 12<sup>1</sup>/<sub>2</sub>"



DeBakey  
03-108-05  
05 cm / 2"



DeBakey  
03-109-05  
05 cm / 2"



Glover  
03-110-06  
06 cm / 2½"



DeBakey  
03-111-06  
06 cm / 2½"

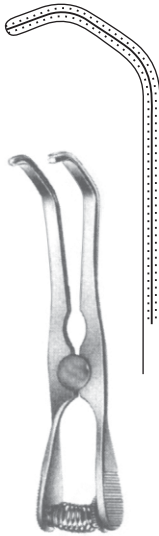

DeBakey  
03-112-10  
10 cm / 4"

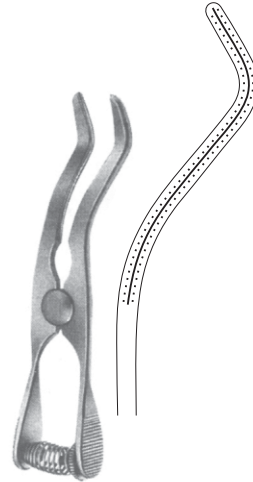

DeBakey  
03-112-09  
09 cm / 3½"



Glover  
03-113-06 06 cm / 2½"  
03-114-09 09 cm / 3½"  
03-115-11 11 cm / 4¾"



Cooley  
03-116-06 06 cm / 3¼"  
03-117-08 08 cm / 3½"  
03-118-13 13 cm / 5½"



DeBakey  
03-119-08 08 cm / 3¼"  
03-120-09 08 cm / 3½"  
03-121-10 10 cm / 5¾"  
03-122-13 13 cm / 4½"



DeBakey  
03-123-08 08 cm / 3¼"  
03-124-09 08 cm / 3½"  
03-125-10 10 cm / 3¾"  
03-126-11 11 cm / 4½"





**Johns-Hopkins**  
03-134-23  
23 cm / 9<sup>3</sup>/<sub>4</sub>"



1/1  
**Bulldog Clamp**  
03-127-05  
4.5 cm / 1<sup>3</sup>/<sub>4</sub>"



1/1  
**Bulldog Clamp**  
03-128-05  
4.5 cm / 1<sup>3</sup>/<sub>4</sub>"



1/1  
**Bulldog Clamp**  
03-129-04  
3.5 cm / 1<sup>1</sup>/<sub>2</sub>"

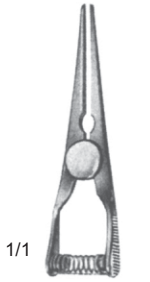

1/1  
**Bulldog Clamp**  
03-129-05  
3.5 cm / 1<sup>1</sup>/<sub>2</sub>"



1/1  
**Dieffenbach**  
03-130-05  
5.8 cm / 2"

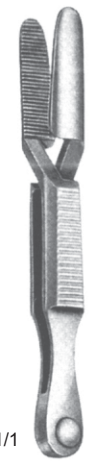

1/1  
**Dieffenbach**  
03-131-05  
5.8 cm / 2"



1/1  
**Dieffenbach**  
03-132-05  
4.0 cm / 1<sup>1</sup>/<sub>2</sub>"



1/1  
**Dieffenbach**  
03-133-04  
5.0 cm / 2"

- Johns-Hopkins**
- 03-135-04 04 cm / 1<sup>1</sup>/<sub>2</sub>"
- 03-135-05 05 cm / 2"
- 03-135-06 06 cm / 2"
- 03-135-07 07 cm / 2<sup>1</sup>/<sub>2</sub>"
- 03-135-08 08 cm / 2<sup>3</sup>/<sub>4</sub>"
- 03-135-09 09 cm / 3"
- 03-135-10 10 cm / 3<sup>1</sup>/<sub>2</sub>"



1/1  
**DeBakey-Hess**  
03-136-05  
05 cm / 2"



1/1  
**DeBakey-Hess**  
03-137-05  
4.5 cm / 1<sup>3</sup>/<sub>4</sub>"



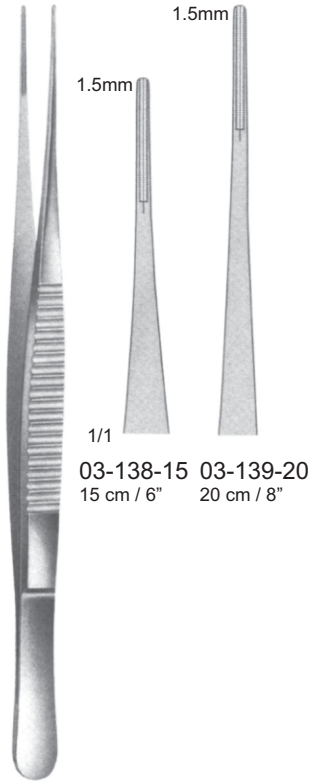

DeBakey  
03-138-15 - 03-139-20

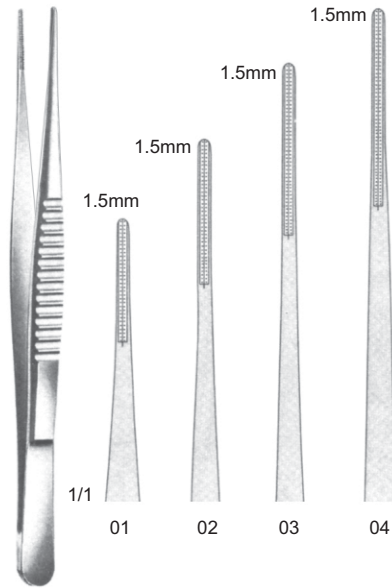

DeBakey  
03-140-15 15 cm / 6" (01)  
03-141-20 20 cm / 8" (02)  
03-142-24 24 cm / 9½" (03)  
03-143-30 30 cm / 12" (04)

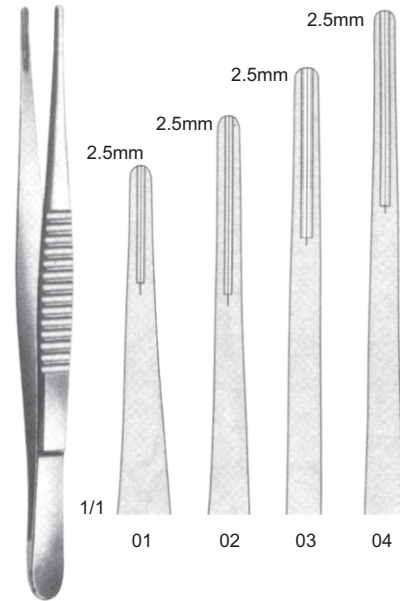

DeBakey  
03-144-15 15 cm / 6" (01)  
03-145-20 20 cm / 8" (02)  
03-146-24 24 cm / 9½" (03)  
03-147-30 30 cm / 12" (04)

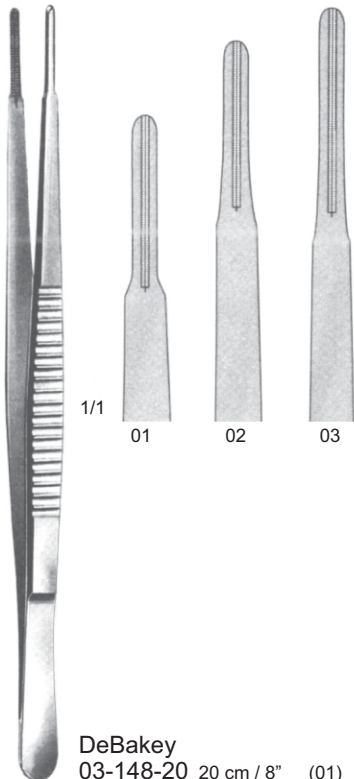

DeBakey  
03-148-20 20 cm / 8" (01)  
03-149-24 24 cm / 9½" (02)  
03-150-30 30 cm / 12" (03)

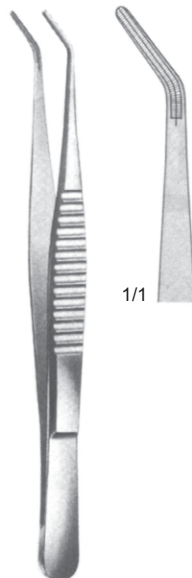

DeBakey  
03-151-15 15 cm / 6"

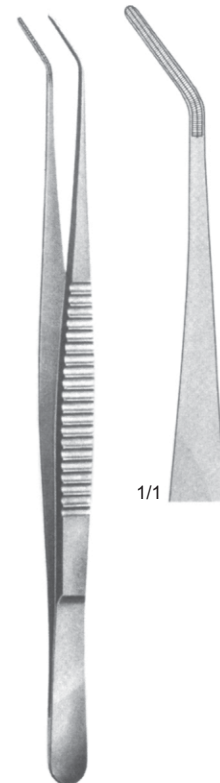

DeBakey  
03-152-20 20 cm / 8"





**Bainbridge**  
03-153-15 - 03-154-18

1/1  
03-153-15  
15 cm / 6"

1/1  
03-154-18  
18 cm / 7"



**DeBakey**  
03-155-16  
16,5 cm / 6½"

1/1



**DeBakey**  
03-156-20 20.5 cm / 8" (01)  
03-157-22 22.5 cm / 9" (02)  
03-158-24 24.5 cm / 9¾" (03)

1/1

01



02



03



**DeBakey**  
03-159-20 20.5 cm / 8" (01)  
03-160-22 22.5 cm / 9" (02)  
03-161-24 24.5 cm / 9¾" (03)

1/1

01



02



03



DeBakey  
03-162-18 - 03-166-28

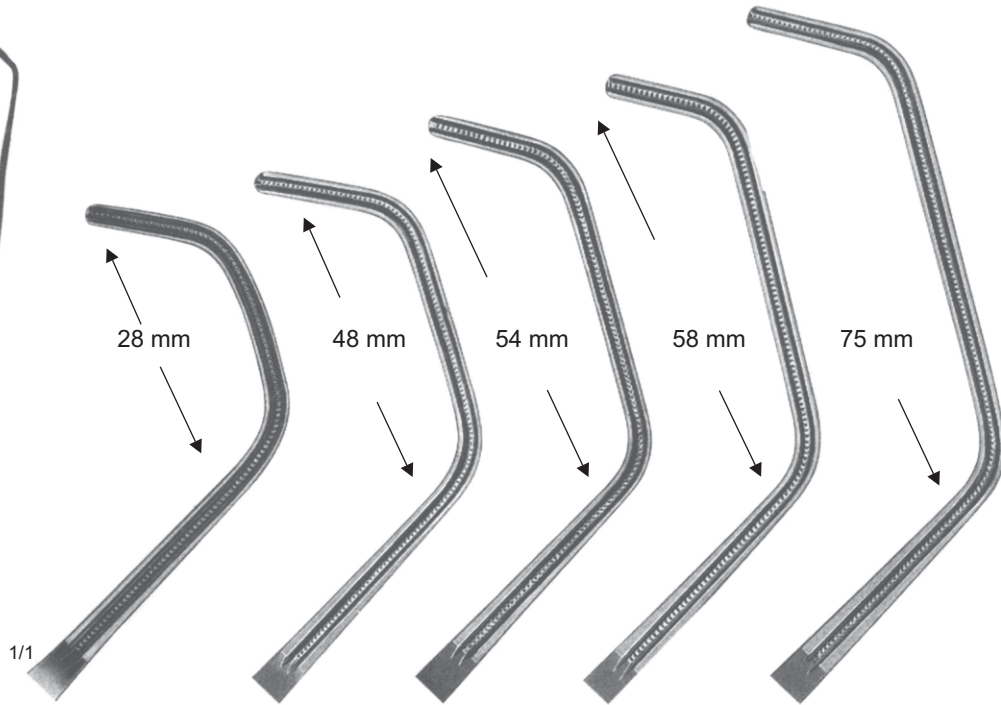

03-162-18  
18 cm / 7"

03-163-26  
26 cm / 10 1/4"

03-164-27  
27,5 cm / 10 3/4"

03-165-27  
27,5 cm / 10 3/4"

03-166-28  
28 cm / 11"

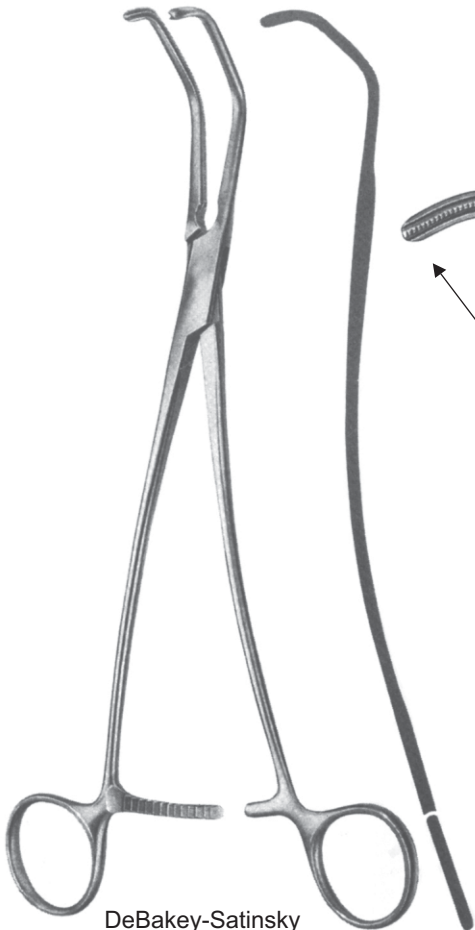

DeBakey-Satinsky  
03-167-28 - 03-169-24

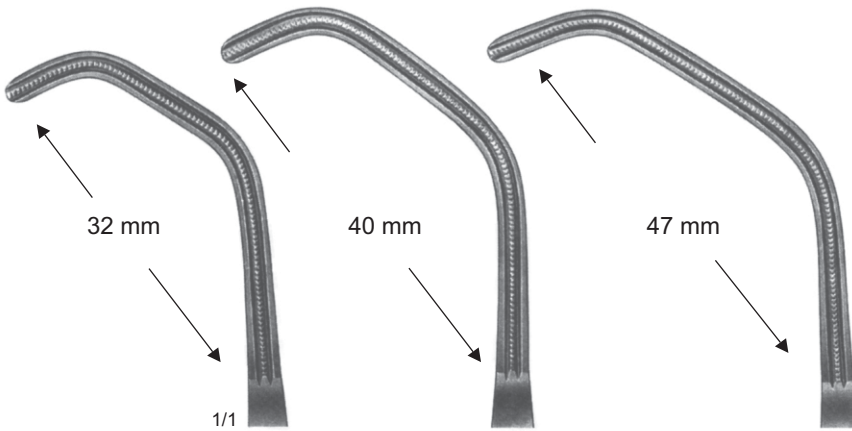

03-167-23  
23,5 cm / 9 1/4"

03-168-24  
24 cm / 9 1/2"

03-169-24  
24,5 cm / 9 3/4"





DeBakey  
03-170-23 - 03-173-24

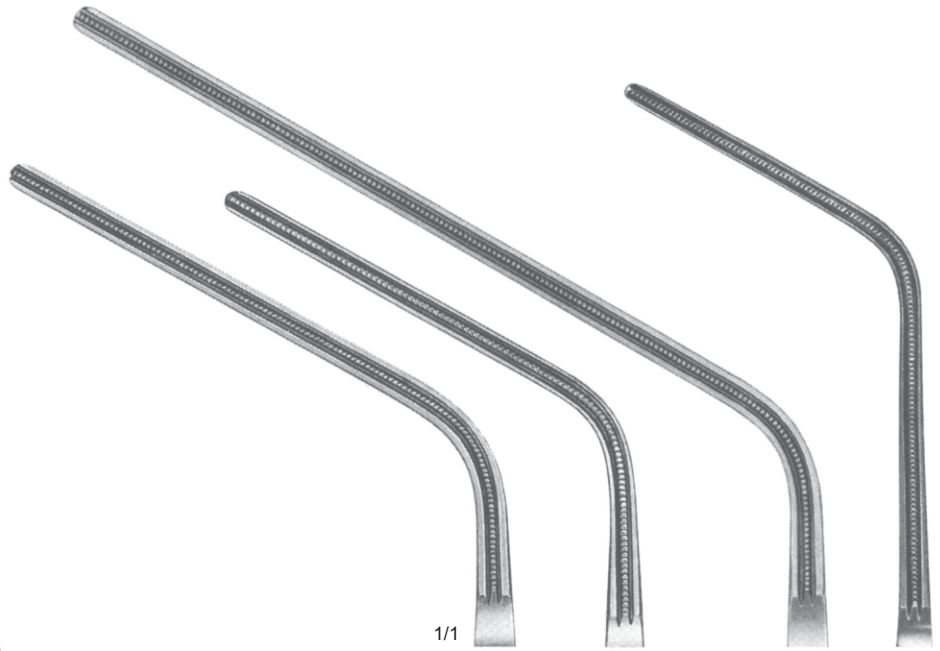

1/1

03-170-23  
23 cm / 9"

03-171-28  
28 cm / 11"

03-172-30  
30,5 cm / 12"

03-173-24  
24 cm / 9½"



DeBakey  
03-174-22 - 03-177-37

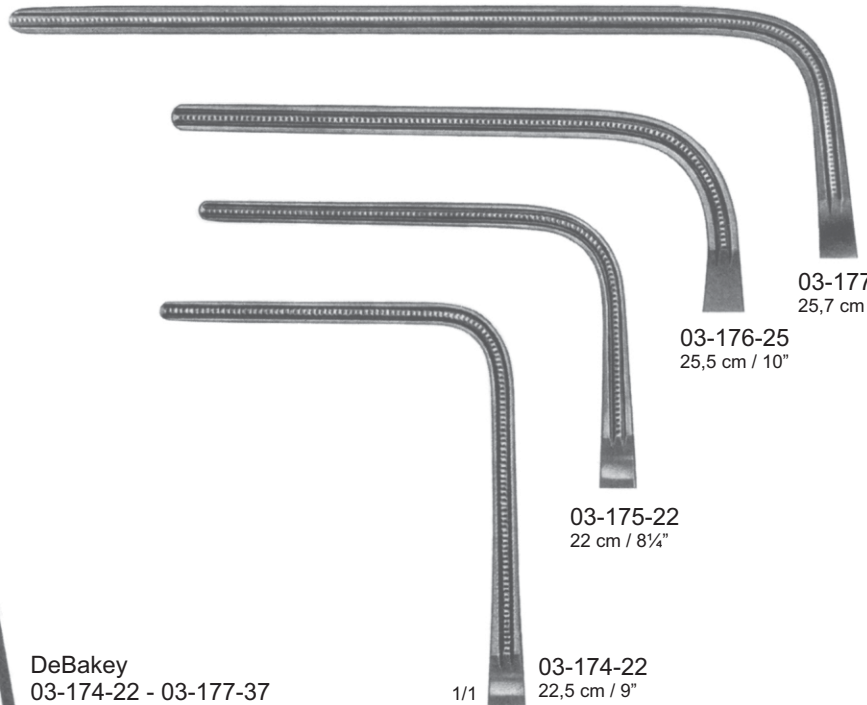

1/1

03-174-22  
22,5 cm / 9"

03-175-22  
22 cm / 8¾"

03-176-25  
25,5 cm / 10"

03-177-25  
25,7 cm / 10¾"



Fixing  
03-178-14  
14 cm / 5½"



Dissecting  
03-178-13  
13 cm / 5"

Vasectomy Set  
03-178-00  
Set of 2

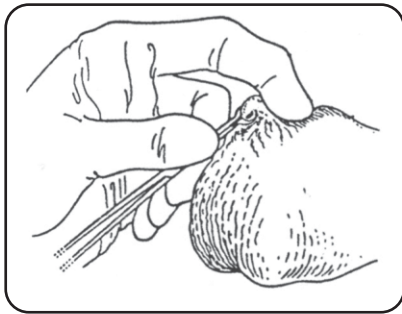

Fig. 1 Fixation of the vas

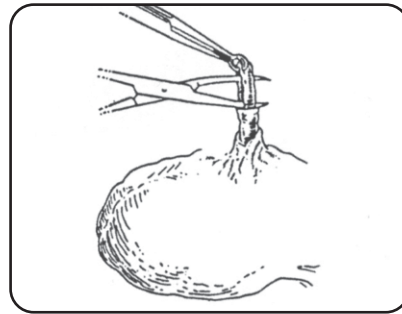

Fig. 4 Catching and freeing the vas deferens

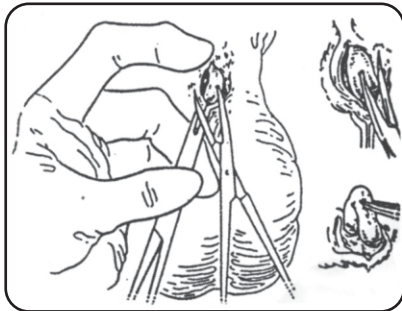

Fig. 2 Separating the Scrotal wall and the vas deferens

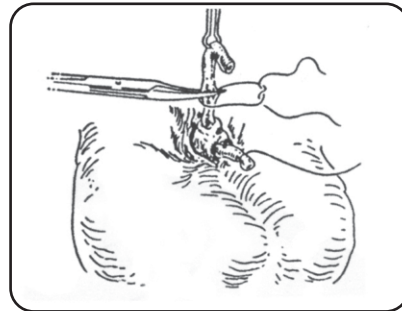

Fig. 5 Ligation of the vas deferens

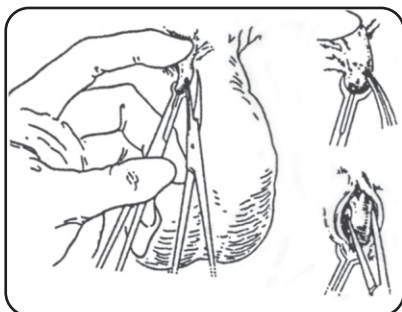

Fig. 2 Elevation of the vas deferens

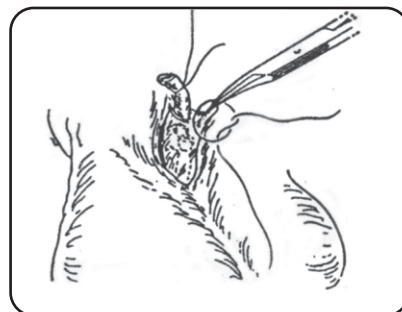
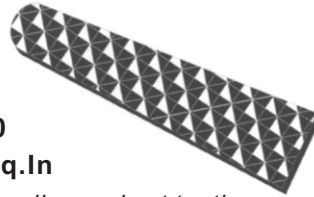

Fig. 8 Embedding of the Epididymal end of vas deferens





**A GUIDE TO  
INSERT SELECTION**



**2500  
Teeth/Sq.In**

*Large size diamond cut teeth  
for use with heavy needles and  
suture (4/0 and larger)*

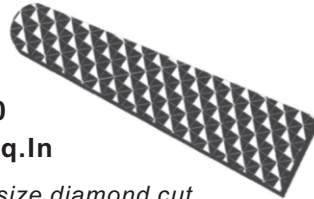

**4000  
Teeth/Sq.In**

*Medium size diamond cut  
teeth for use with fine  
suture (3/0 to 6/0)*

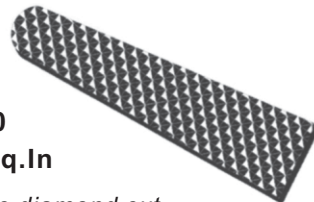

**7000  
Teeth/Sq.In**

*Extra-fine diamond cut  
teeth for use with only delicate  
suture (5/0 to 8/0)*

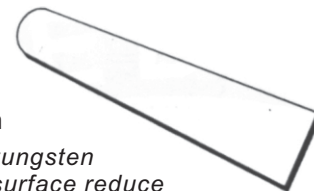

**Smooth**

*Smooth tungsten  
carbide surface reduce  
damage to delicate needles  
and sutures (6/0 and finer).*



Order  
Please order your required teeth size in addition to the  
regular catalogue no of our product.  
Example: 1 X TC needle holder 0103321 teeth 4000



[www.krnano.com](http://www.krnano.com)

니들 홀더

**NEEDLE HOLDERS**

**Page 078 - 084**

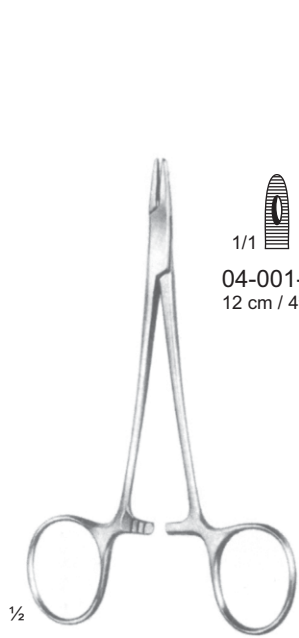

Derf  
04-001-12 - 04-002-12



04-001-12  
12 cm / 4 3/4"



Webster  
04-003-13  
13 cm / 5"

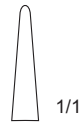

04-002-12  
12.5 cm / 5"

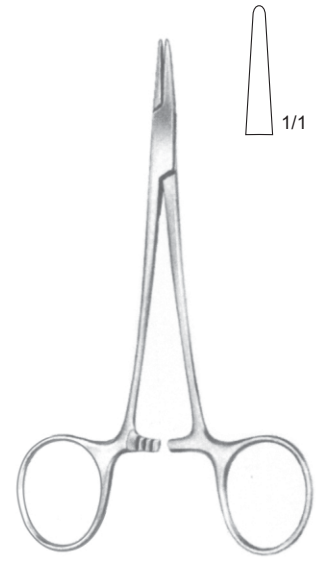

Halsey  
04-004-13  
13 cm / 5"

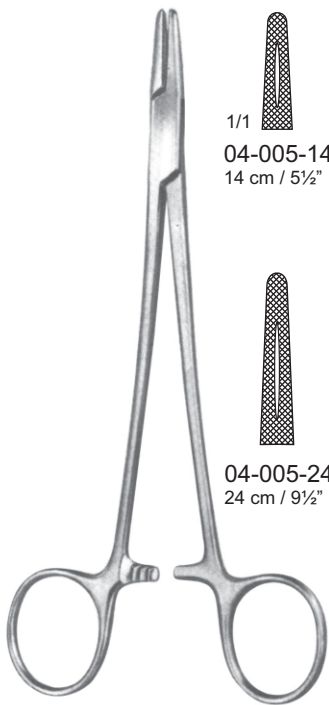

Mayo-Hegar  
04-005-14 - 04-005-30

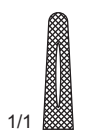

04-005-14  
14 cm / 5 1/2"

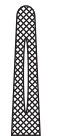

04-005-16  
16 cm / 6 1/4"



04-005-18  
18 cm / 7"

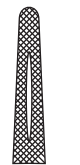

04-005-20  
20 cm / 8"



04-005-24  
24 cm / 9 1/2"

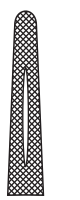

04-005-26  
26 cm / 10 1/4"

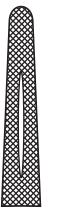

04-005-30  
30 cm / 12"



Crile-Wood  
15 cm / 6"



04-006-15

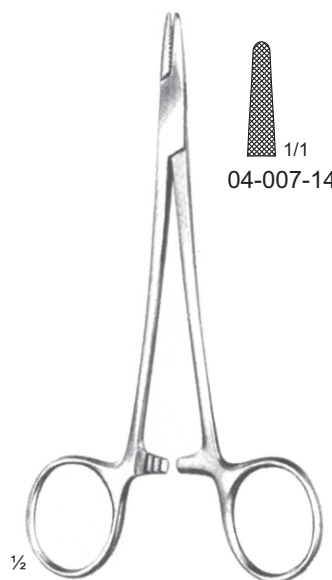

Hegar-Baumgartner  
14 cm / 5 1/2"



04-007-14



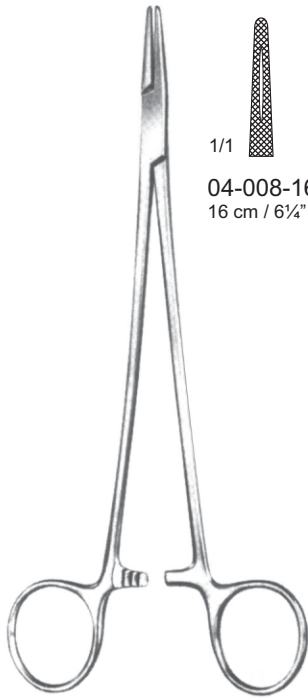

Mayo-Hegar (Delicate)  
04-008-16 - 04-008-20

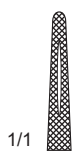

1/1  
04-008-16  
16 cm / 6¼"



04-008-18  
18 cm / 7"



04-008-20  
20 cm / 8"

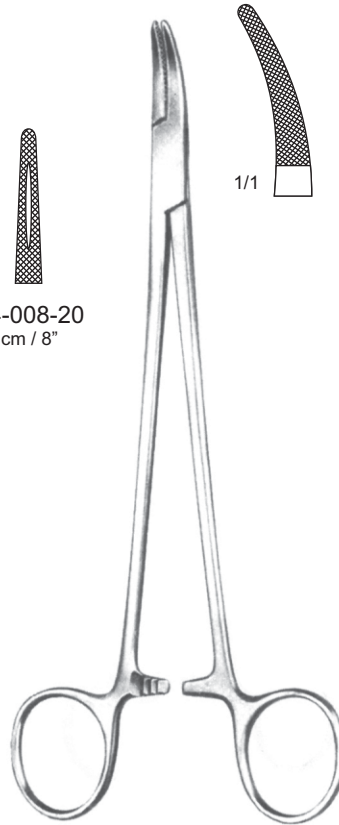

Heaney  
04-009-21  
21 cm / 8¼"

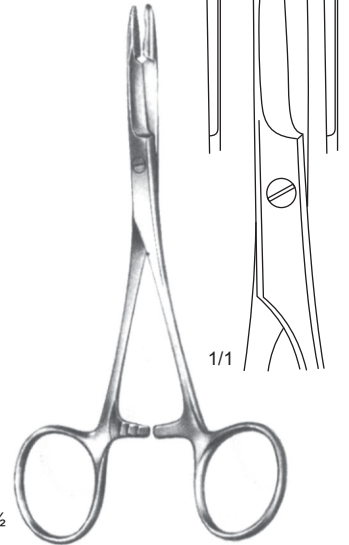

Olsen-Hegar  
04-010-14  
14 cm / 5½"

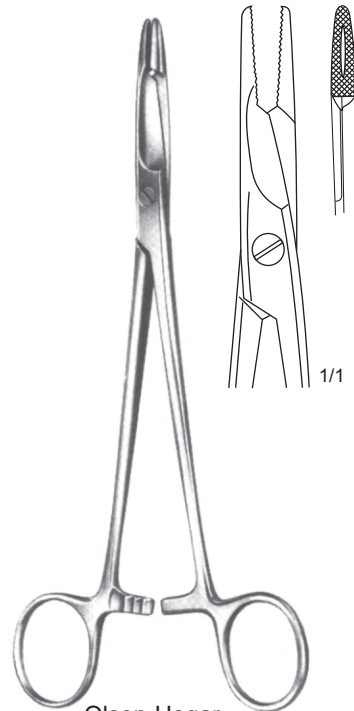
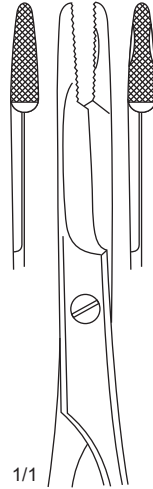

Olsen-Hegar  
04-011-14 14 cm / 5½"  
04-011-16 16.5 cm / 6½"  
04-011-18 18 cm / 7"

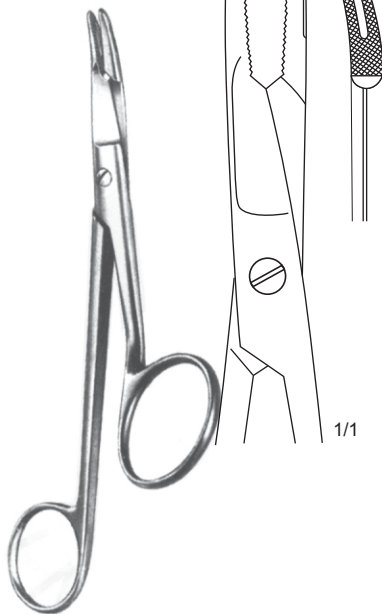
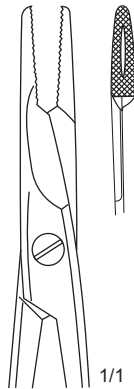

Gillies  
04-012-16  
16 cm / 6¼"



Mathieu  
04-013-14 - 04-015-20



1/1  
04-013-14  
14 cm / 5½"



04-014-17  
17 cm / 6¾"



04-015-20  
20 cm / 8"





**Webster TC**  
04-016-13  
13 cm / 5"



**Derf TC**  
04-017-12  
12 cm / 4 3/4"

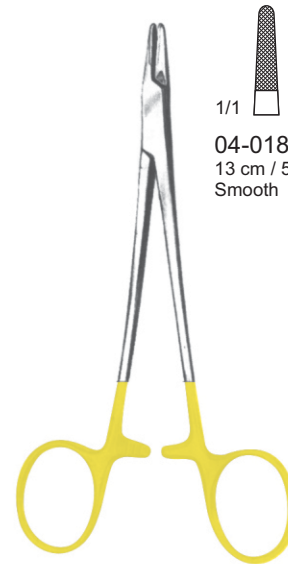

**Hegar-Baumgartner TC**  
04-018-13 - 04-018-14

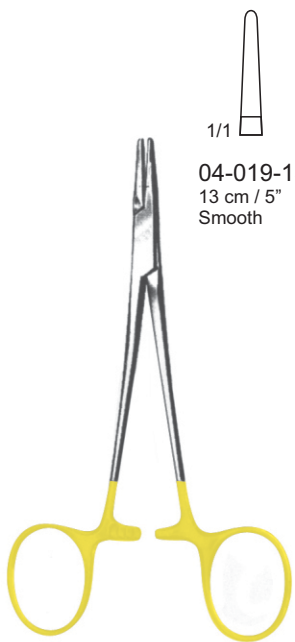
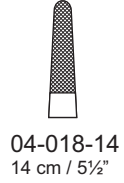
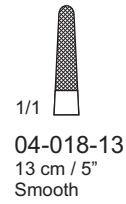

**Halsey TC**  
04-019-13 - 04-020-13  
13 cm / 5"

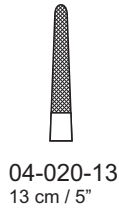

**Webster TC**  
04-021-12  
12 cm / 4 3/4"



**Crile-Wood TC**  
04-022-15  
15 cm / 6"

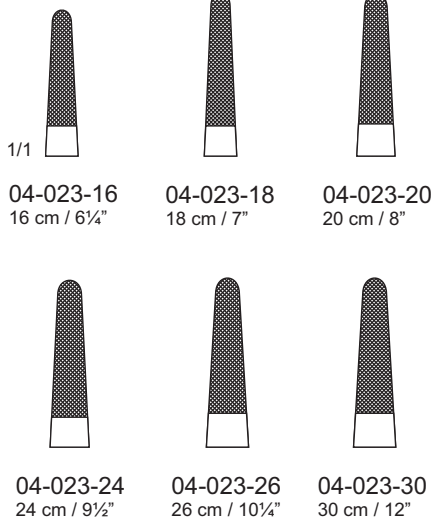
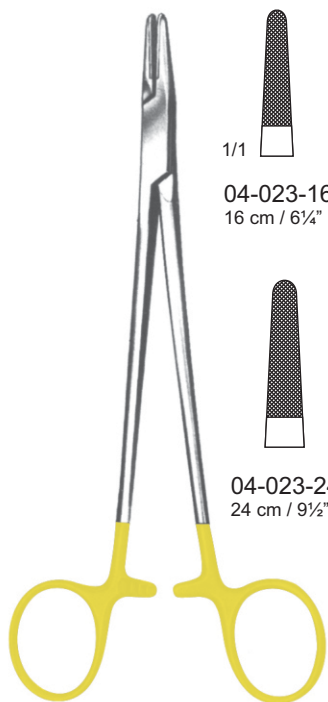

**Mayo-Hegar TC**  
04-023-16 - 04-023-30

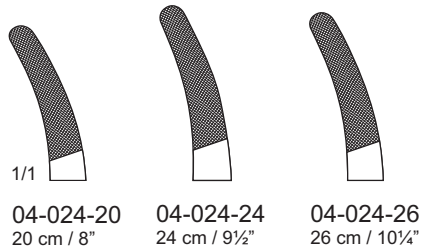
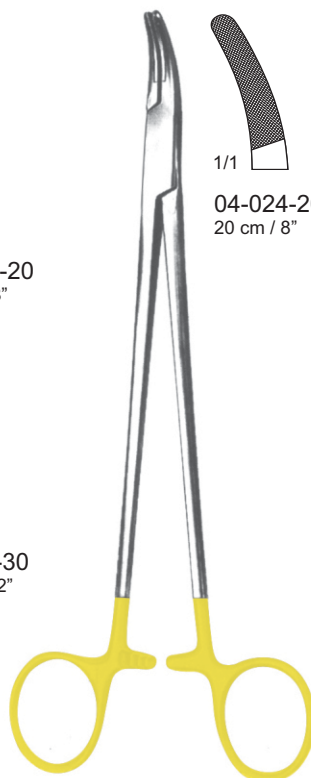

**Mayo-Hegar (Heaney) TC**  
04-024-20 - 04-024-26

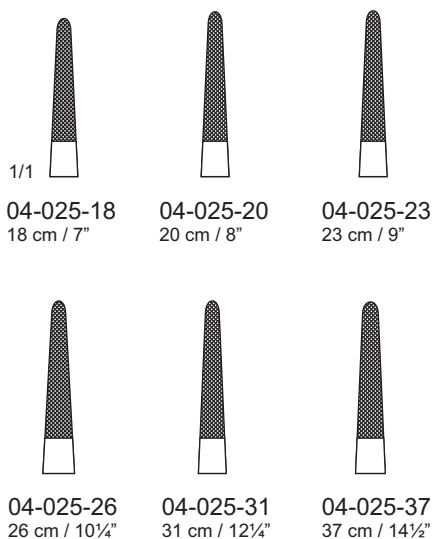
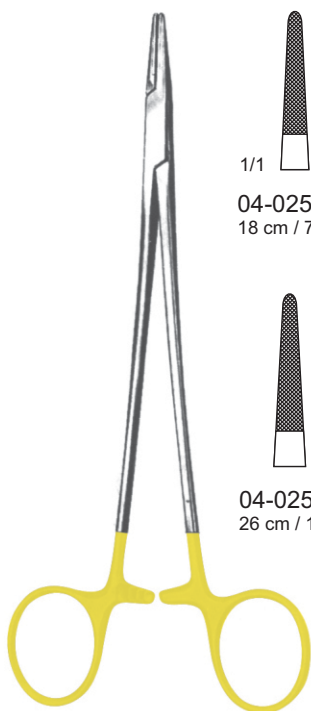

**DeBakey TC**  
04-025-18 - 04-025-37

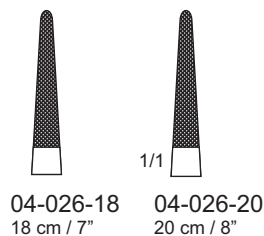
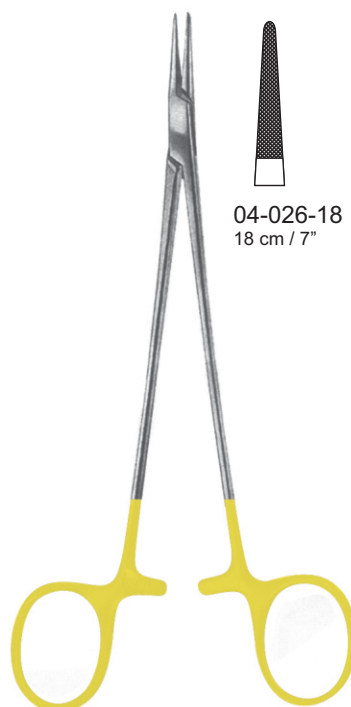

**Microvascular TC**  
04-026-18 - 04-026-20





**Olsen-Heger TC**  
04-027-14 - 04-027-18

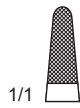

1/1  
**04-027-14**  
14 cm / 5½"



**04-027-17**  
16,5 cm / 6½"



**04-027-18**  
18 cm / 7"



**Gillies TC**  
04-028-16  
16 cm / 6¼"

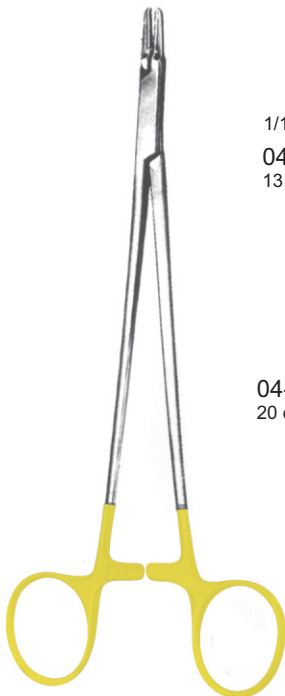

**Ryder (Medro) TC**  
04-029-13 - 04-029-26



1/1  
**04-029-13**  
13 cm / 5"



**04-029-15**  
15 cm / 6"



**04-029-18**  
18 cm / 7"



**04-029-20**  
20 cm / 8"



**04-029-23**  
23 cm / 9"



**04-029-26**  
26 cm / 10¼"

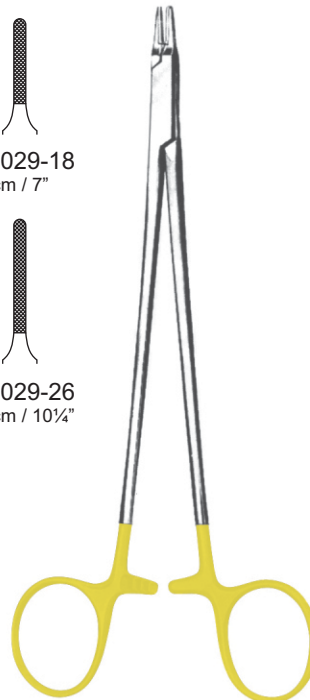

**Ryder Vascular TC**  
04-030-13 - 04-030-26



1/1  
**04-030-13**  
13 cm / 5"



**04-030-15**  
15 cm / 6"



**04-030-18**  
18 cm / 7"



**04-030-20**  
20 cm / 8"



**04-030-23**  
23 cm / 9"



**04-030-26**  
26 cm / 10¼"



04-031-14  
14 cm / 5½"



04-031-17  
17 cm / 6½"



04-031-20  
20 cm / 8"

Mathieu TC  
04-031-14 - 04-031-20



04-032-15  
15 cm / 6"

Wire Twister TC  
04-032-15



04-032-20  
20 cm / 8"

Wire Twister TC  
04-032-20





**Langenbeck TC**  
 04-033-14 14 cm / 5½"  
 04-033-16 16 cm / 7¼"  
 04-033-18 18 cm / 7"  
 04-033-20 20 cm / 9"  
 04-033-23 23 cm / 9"



**Wire Twister TC**  
 04-034-13 13 cm / 5½"  
 04-034-16 16 cm / 7¼"  
 04-034-18 18 cm / 7"



**Wire Twister (Heavy) TC**  
 04-035-18

04-035-18  
 18,5 cm / 7¼"

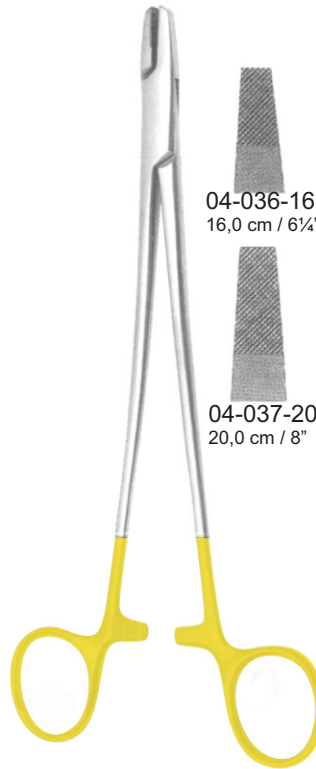

**Wire Twister (Flat) TC**  
 04-036-16 - 04-037-20

04-036-16  
 16,0 cm / 6¼"

04-037-20  
 20,0 cm / 8"



[www.krnano.com](http://www.krnano.com)

드레싱 및 조직 핀셋

**DRESSING & TISSUE FORCEPS**

Page 086 - 095



Standard / Dressing  
05-001-10 - 05-001-30

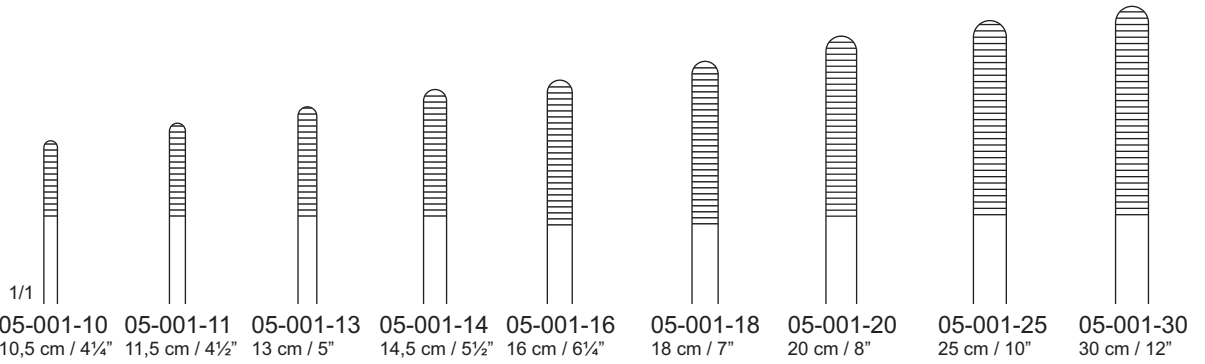

Tissue 1x2 Teeth  
05-002-10 - 05-002-30

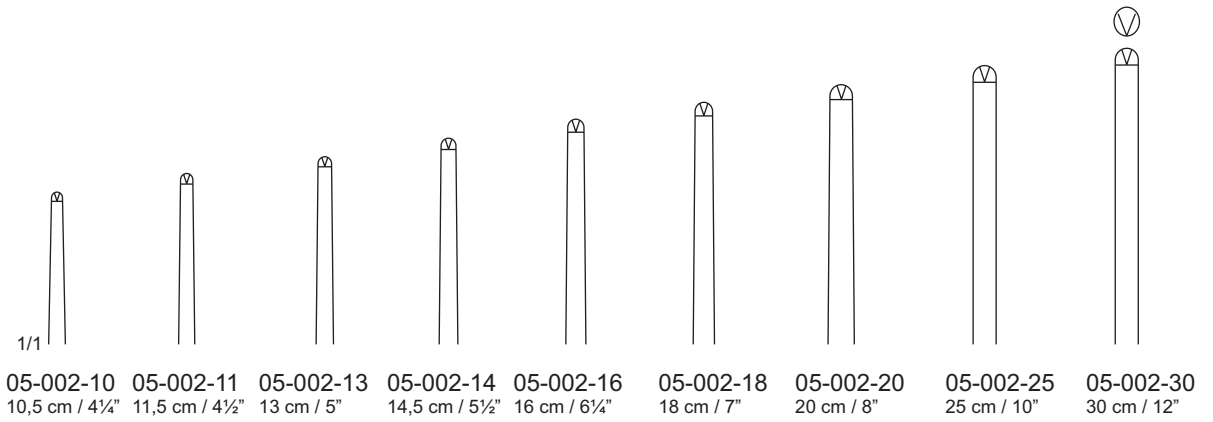





Tissue 2x3  
05-003-11 - 05-003-25

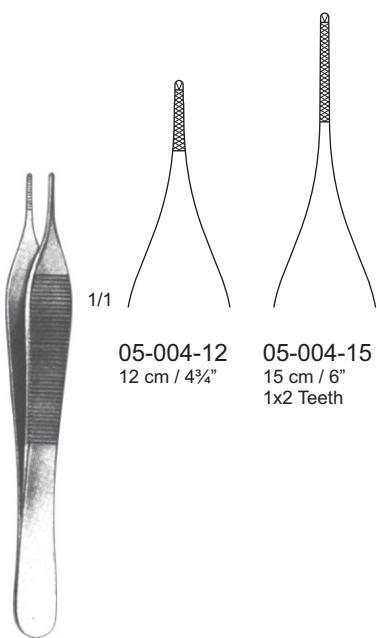
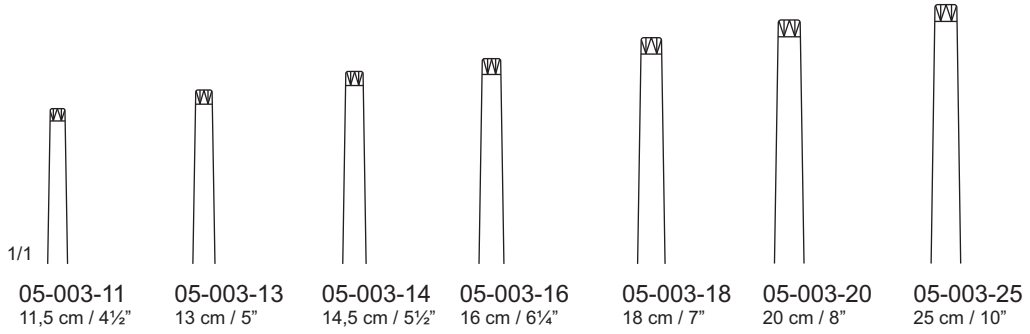

Mini Adson  
05-004-12 - 05-004-12

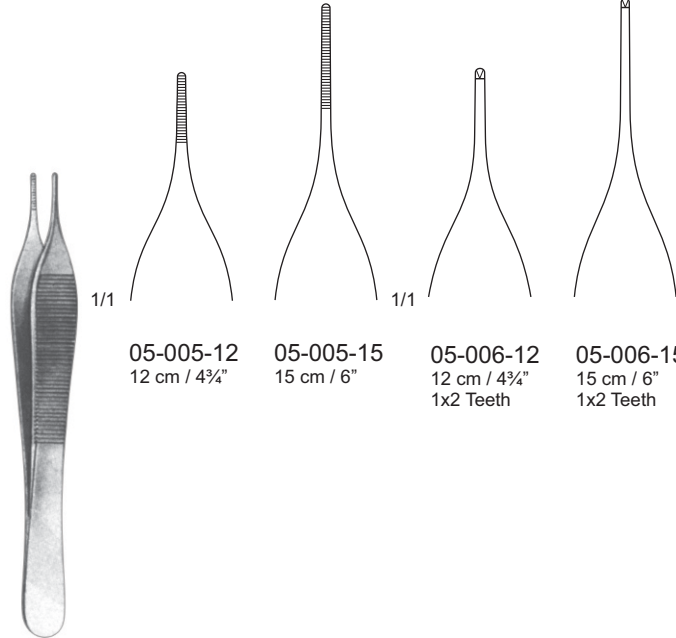

Adson  
05-005-12 - 05-006-15

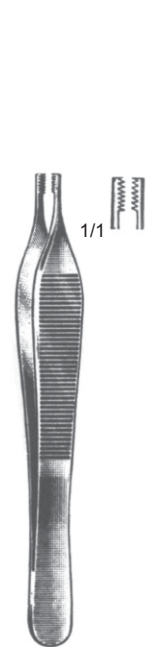

Adson-Brown  
05-007-12  
12 cm / 4¾"



**Micro-Adson**  
12 cm / 4¾"

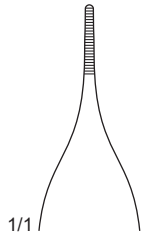

05-008-13  
12 cm / 4¾"

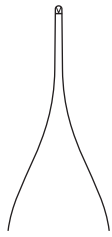

05-009-13  
1x2 Teeth



**Cushing**  
05-010-17 - 05-011-17  
17,5 cm / 7"

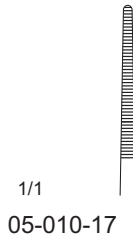

1/1  
05-010-17



05-011-17



**Cushing**  
05-012-17  
17,5 cm / 8¾"



1/1



**Semken**  
05-013-12 - 05-014-15

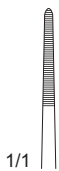

1/1  
05-013-12  
12,5 cm / 5"



05-013-15  
15 cm / 6"

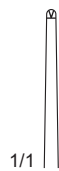

1/1  
05-014-12  
12,5 cm / 5"



05-014-15  
15 cm / 6"



**Gillies**  
05-015-15  
15 cm / 6"



1/1



**McIndoe**  
05-016-15  
15 cm / 6"



1/1

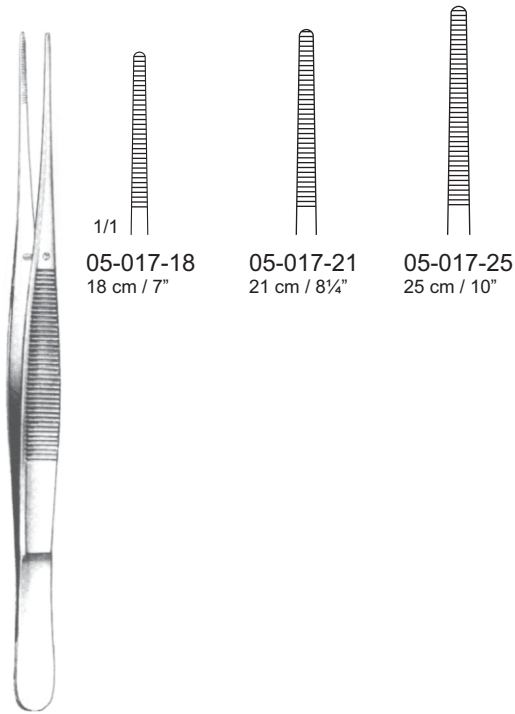

05-017-18  
18 cm / 7"

05-017-21  
21 cm / 8¼"

05-017-25  
25 cm / 10"

**Potts-Smith**  
05-017-18 - 05-017-25

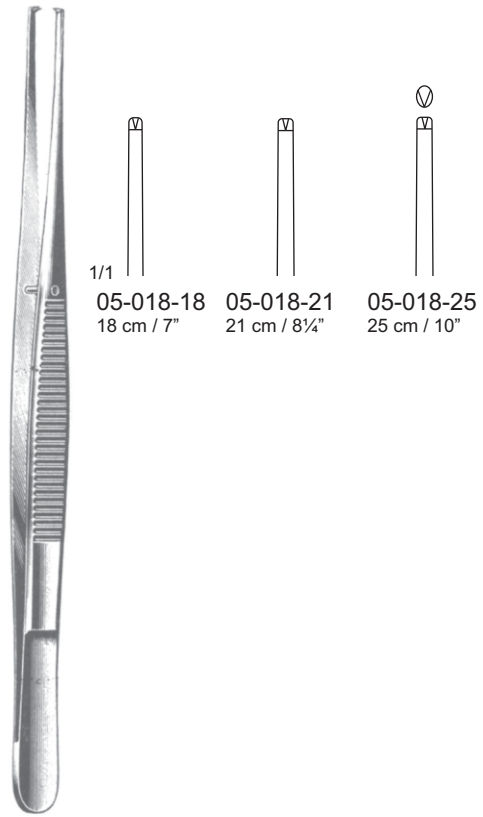

05-018-18  
18 cm / 7"

05-018-21  
21 cm / 8¼"

05-018-25  
25 cm / 10"

**Potts-Smith 1x2 Teeth**  
05-018-18 - 05-018-25

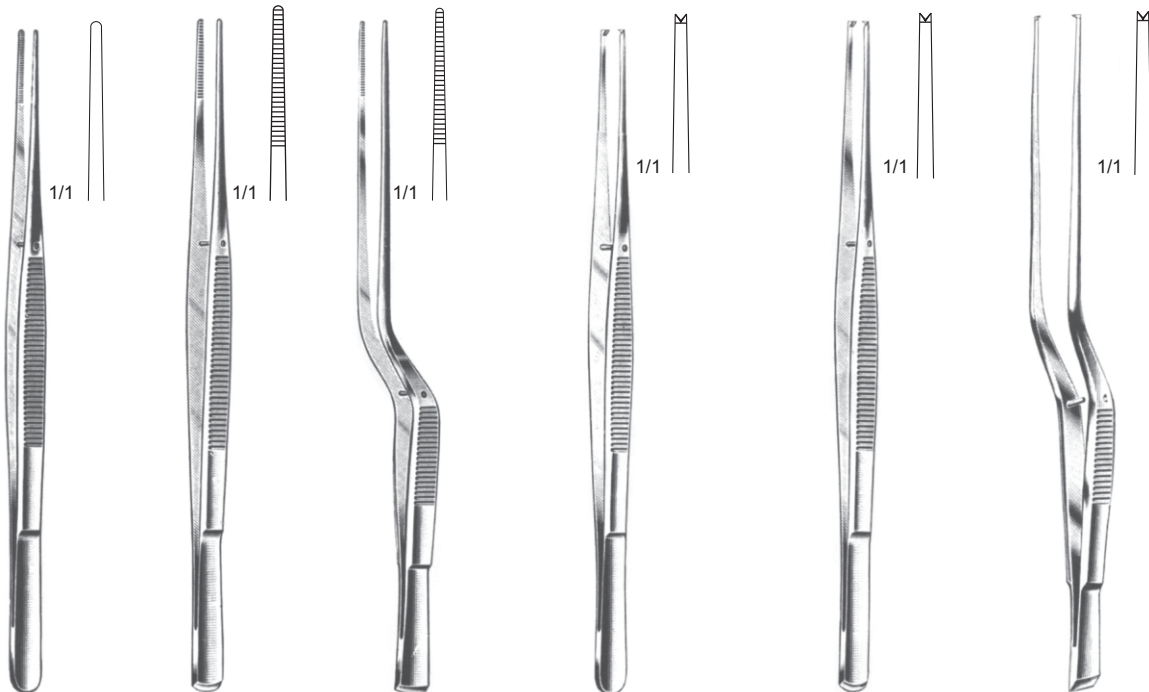

Taylor  
05-019-17  
17 cm / 7"

Taylor  
05-020-17  
17 cm / 7"

Taylor  
05-021-17  
17 cm / 7"

Taylor  
05-022-17  
17 cm / 7"

Taylor  
05-023-17  
17 cm / 7"

Taylor  
05-024-17  
17 cm / 7"





Russ. Modell  
05-025-15 - 05-025-25



05-025-15  
15 cm / 6"



05-025-20  
20 cm / 8"



05-025-25  
25 cm / 10"



Bonney  
05-026-18 - 05-027-18  
18 cm / 7"

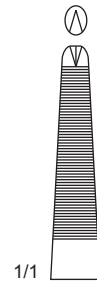

05-026-18  
1x2 Teeth



05-027-18  
2x3 Teeth

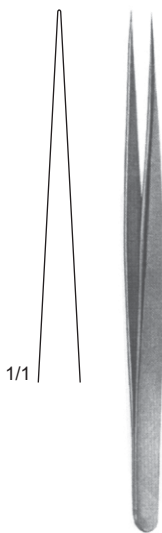

Micro Forceps  
05-028-13  
13 cm / 5 1/4"

1/1

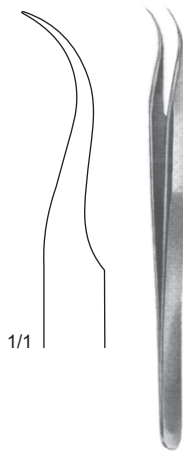

Micro Forceps  
05-029-11  
11,5 cm / 4 1/2"

1/1

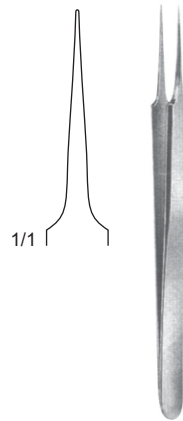

Micro Forceps  
05-030-12  
12 cm / 4 3/4"

1/1

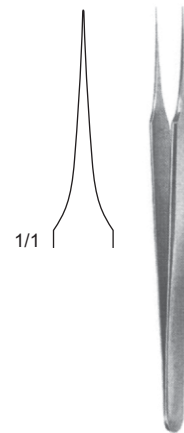

Micro Forceps  
05-031-12  
12 cm / 4 3/4"

1/1



Iris  
05-032-10 - 05-037-10  
10,5 cm / 4 1/4"

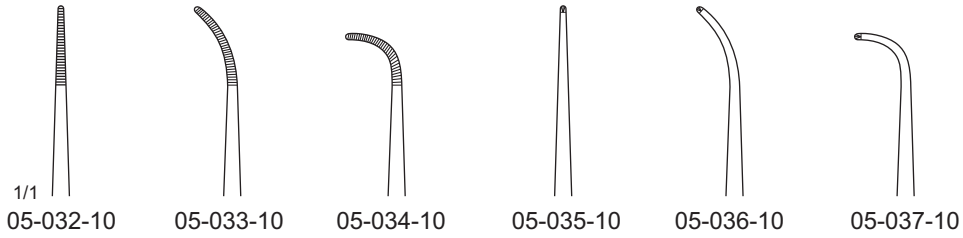

1/1  
05-032-10    05-033-10    05-034-10    05-035-10    05-036-10    05-037-10



Von Graefe  
05-038-07 - 05-039-07  
7 cm / 2 3/4"

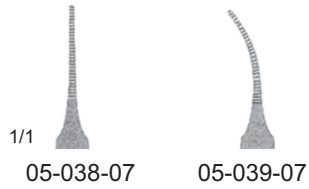

1/1  
05-038-07    05-039-07



Von Graefe 1x2  
05-040-07 - 05-041-07  
7 cm / 2 3/4"

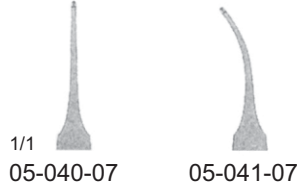

1/1  
05-040-07    05-041-07





**Adson-Brown TC**  
05-047-12  
12 cm / 4 3/4"



**Micro-Adson TC**  
05-048-12 - 05-048-15



05-048-12  
12 cm / 4 3/4"



05-048-15  
15 cm / 6"



**Adson TC**  
05-049-12 - 05-050-15



05-049-12  
12 cm / 4 3/4"



05-050-12  
12 cm / 4 3/4"



05-049-15  
15 cm / 6"



05-050-15  
15 cm / 6"



**Cushing TC**  
05-051-17  
17,5 cm / 7"

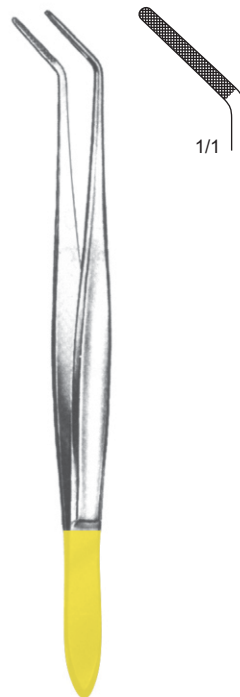

**Cushing TC**  
05-052-18  
18 cm / 7"



**Cushing-Taylor TC**  
05-053-18  
18 cm / 7"

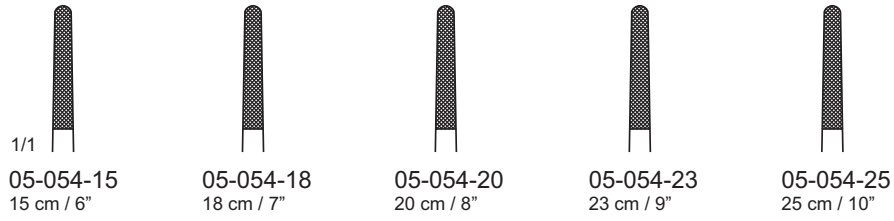

**Potts-Smith TC**  
05-054-15 - 05-054-25

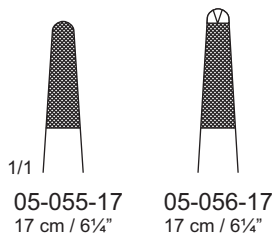

**Bonney TC**  
05-055-17 - 05-056-17



**Gillies TC**  
05-057-15  
15 cm / 6"



**McIndoe TC**  
05-058-15  
15 cm / 6"

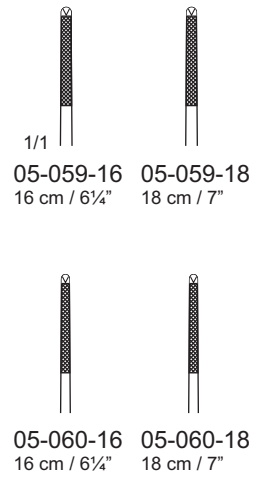

**Semken TC**  
05-059-16 - 05-060-18





**Potts-Smith TC**  
05-054-15 - 05-054-25

1.5 mm



1/1  
**05-061-16**  
16 cm / 6¼"



**05-061-20**  
20 cm / 8"



**05-061-24**  
24 cm / 9½"

2.0 mm

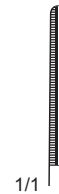

1/1  
**05-062-16**  
16 cm / 6¼"



**05-062-20**  
20 cm / 8"



**05-062-24**  
24 cm / 9½"



**Hunter**  
05-063-10 - 05-064-10  
10.5 cm / 4¼"



1/1  
**05-063-10**

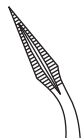

**05-064-10**



**Feilchenfeld**  
05-065-07 - 05-065-11

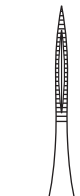

1/1  
**05-065-07**  
7.5 cm / 3"



**05-065-09**  
9 cm / 3½"



**05-065-11**  
11.5 cm / 4½"



**Barraquer**  
05-066-10  
10.5 cm / 4¼"



1/1



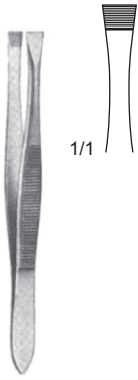

Douglas  
05-067-09  
9 cm / 3½"

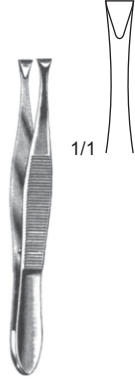

Douglas  
05-068-08  
8.5 cm / 3½"

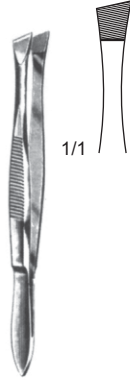

05-069-09  
9 cm / 3½"

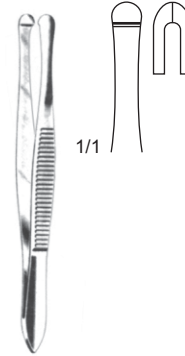

Beer  
05-070-09  
9 cm / 3½"

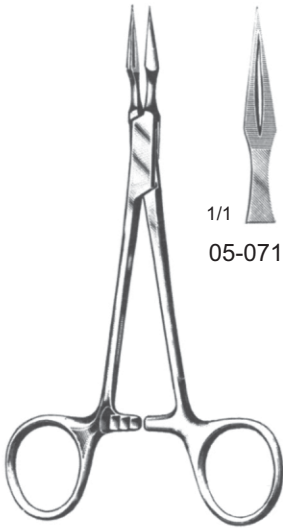

Stieglitz  
05-071-13 - 05-072-13  
13.5 cm / 5½"



05-072-13



Ralk  
05-073-15 - 05-074-15  
15 cm / 6"



05-074-15

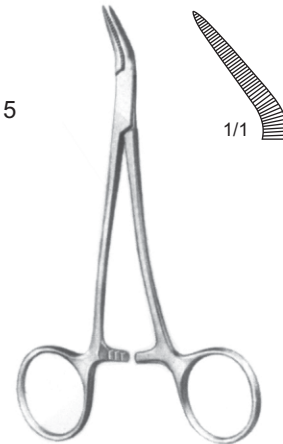

Peet  
05-075-11  
11.5 cm / 4½"





## **TUNGSTEN CARBIDE**

*Tungsten carbide was applied to surgical instruments it is among hardest metals known and is sometimes referred to as man-made diamond. The primary advantage of tungsten Carbide is its hardness which makes it very resistant to wear and corrosion it is also ideal for machining small intricate patterns such as needle holder teeth which require superior Wear resistance.*

*Tungsten carbide inserts are used in surgical instruments enhance their Performance and longevity these insert are micro-bonded to the working end of the Device to provide years of increased performance. Tungsten carbide Needle holder and Forceps grasp more securely and are more durable than their stainless steel counterparts. Tungsten carbide scissors and bone rasps cut better and need much less sharpening than Stainless steel scissor and rasps. Tungsten carbide is a unique material. It has contributed greatly to the art of Surgery by providing increased precision and performance-leading enhanced technique And better patient care is proud to have introduced the surgical world to the benefits of Tungsten carbide through our of surgical Instruments.*

## **INSERT STYLE**

*Tungsten carbide inserts are available in a variety of styles this allows greater flexibility for the surgeon in matching suture and needle size to the insert best suited to Provide maximum grip and Control. These styles reflect the different size of diamond Cut teeth and type of holding surface. Generally the inserts with larger teeth (2500 and 4000 teeth per square inch) are used for heavier needles and tissues. The inserts with smaller teeth and textured surface (7000 teeth) are used for more delicate needles and tissues.*



Please see the guide chart of TC types on page 76



[www.krnano.com](http://www.krnano.com)

안과

OPHTHALMIC INSTRUMENTS

Page 098 - 115



**Weiss**  
06-001-01 Solid for adults  
06-001-02 Solid for infants  
06-001-03 Fenestrated for adults  
06-001-04 Fenestrated for infants



**Castroviejo**  
06-002-01 Small  
06-002-02 Medium  
06-002-03 Large



**Holtzheimer 4-teeth**  
06-003-10 10 cm 4<sup>n</sup> Sharp Str.  
06-004-10 10 cm 4<sup>n</sup> Blunt Str.  
06-005-10 10 cm 4<sup>n</sup> Sharp Cvd  
06-006-10 10 cm 4<sup>n</sup> Blunt Cvd

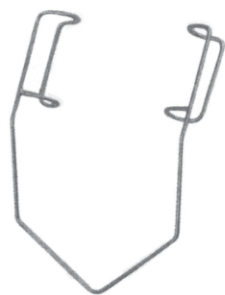

**Barraquer**  
06-007-01 Fenestrated  
06-007-02 Fenestrated for infants



**Desmarres**  
9 cm / 3½

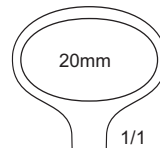

20mm  
1/1  
06-008-09

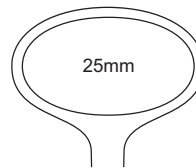

25mm  
06-009-09

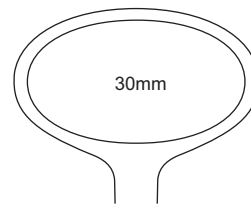

30mm  
06-010-09

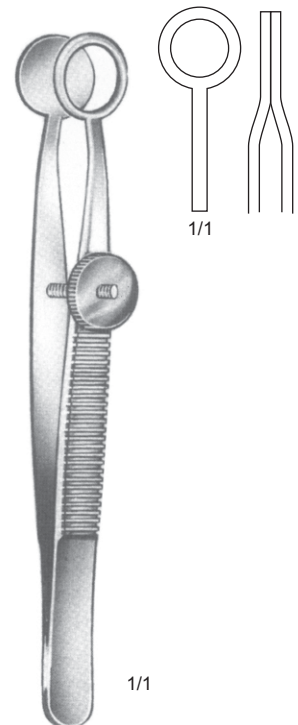

**Lambert**  
9.5 cm / 3½  
06-011-09



1/2

**Bishop-Harmon**  
06-012-09 - 06-015-09  
8.5cm / 3 1/2"



1/1

06-012-09 Fine Tip  
06-013-09 Standard



1/1

1x2 teeth  
06-014-09 Fine Tip  
06-015-09 Standard



**Gill**  
06-016-07 - 06-018-07  
7.0cm / 3 3/4"



1/1

1x2 teeth  
06-016-07 Extra Delicate  
06-017-07 Standard



1/1

**Gill-Chandler**  
06-018-07



1/2

**Gill-Hess**  
06-019-07  
7.5 cm / 3"



1/1

1x2 teeth



**Colibri**  
With tying platform  
8.3 cm / 3 1/4"

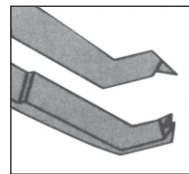

06-020-08

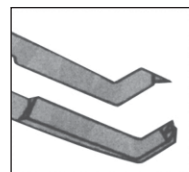

06-021-08  
Extra delicate



**Bonn**  
Suture Forceps  
8.3 cm / 3 1/4"

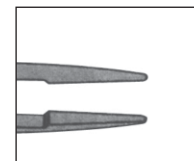

06-022-08



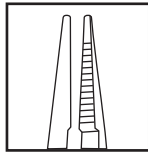
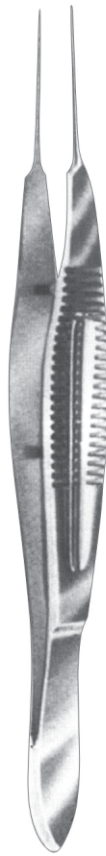

**Castroviejo**  
06-023-11  
11 cm / 4 1/2"

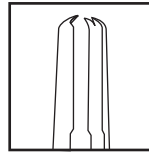
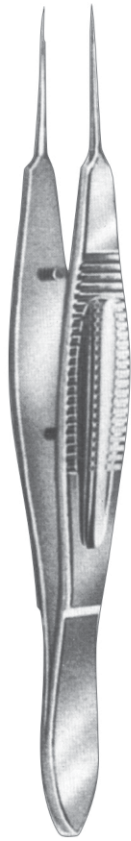

**Castroviejo**  
06-024-12 0.12 mm  
06-024-30 0.30 mm  
06-024-50 0.50 mm  
06-024-70 0.70 mm  
11 cm / 4 1/2"



**Castroviejo TC**  
06-025-30 0.30 mm  
06-025-50 0.50 mm  
10.5 cm / 4 1/2"

Tip 0.3 mm

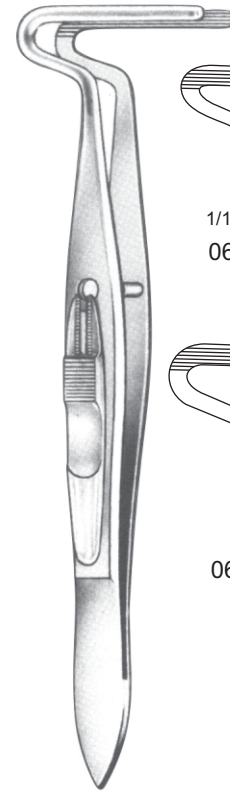

1/1  
06-026-11

06-027-11

**Berke**  
10.8 cm / 4 1/4"



1/2  
**Micro Suture Tying**

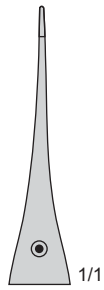

1/1  
06-028-12 12 cm / 4 3/4"  
06-028-15 15 cm / 6"



1/1  
06-029-12 12 cm / 4 3/4"  
06-029-15 15 cm / 6"

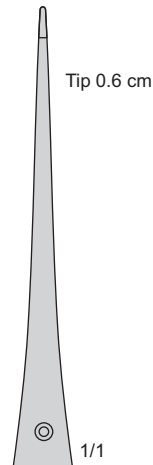

Tip 0.6 cm  
1/1  
06-028-18 18 cm / 7"  
06-028-23 23 cm / 9"

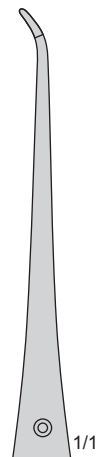

1/1  
06-029-18 18 cm / 7"  
06-029-23 23 cm / 9"



1/2  
**Rhoton**  
18 cm / 7"



1/1  
06-030-18 Str



1/1

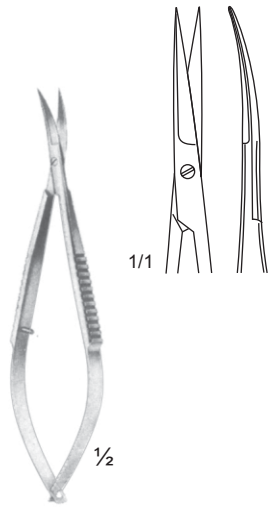

06-032-11  
11 cm / 4½"

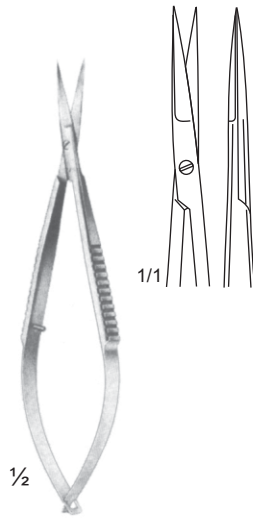

06-033-12  
12 cm / 4¾"

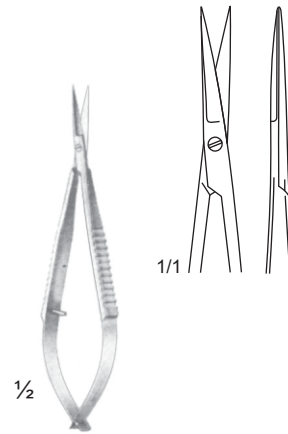

06-034-09  
09 cm / 3½"

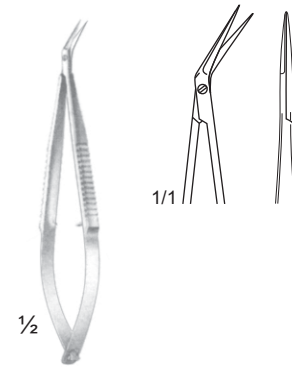

06-035-09  
09 cm / 3½"

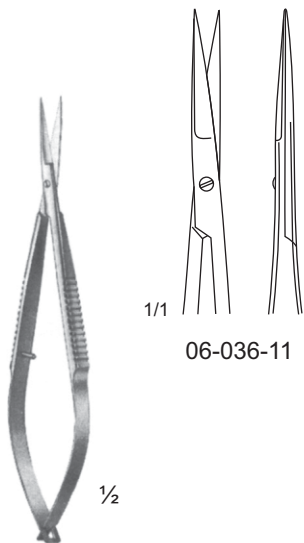

Westcott  
06-036-11 - 06-037-11  
11 cm / 4½"

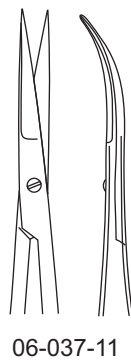

06-037-11

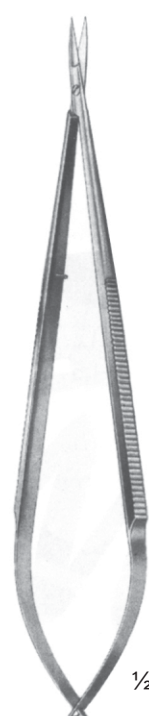

06-038-18  
06-040-18  
18.5 cm / 7½"

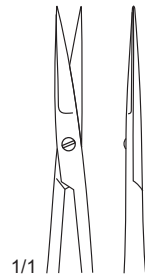

06-038-18



06-039-18



06-040-18



Vannas-Tubingen  
06-041-08 Str  
06-042-08 Cvd  
08 cm / 3"



06-043-08 Str



06-044-08 Cvd

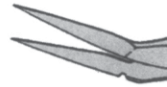

06-045-08 Bent



06-046-08 Angled on flat



06-047-08 Str



06-048-08 Cvd

Vannas very delicate  
08 cm / 3"

Traberular  
08 cm / 3"

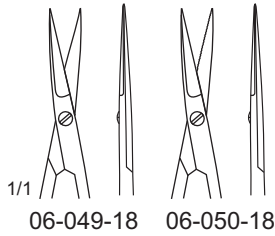

06-049-18 06-050-18

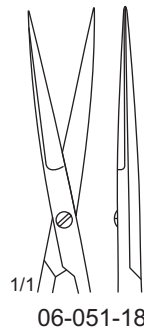

06-051-18

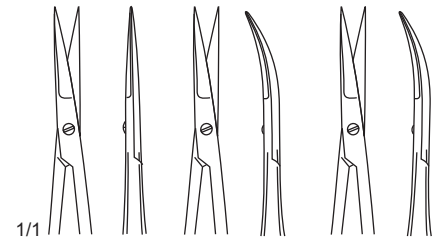

06-052-14 14 cm / 5 1/2"  
06-053-15 15 cm / 6"  
06-054-15 15 cm / 6"  
1 blade serr.  
Reill



06-049-18 - 06-050-18  
18 cm / 7 1/4"



Hepp/Scheidel  
18 cm / 7 1/4"

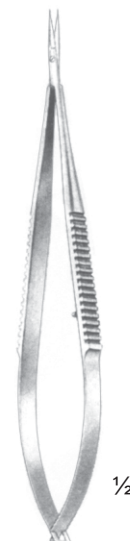

06-052-14 - 06-054-15



Ribbon Scissors

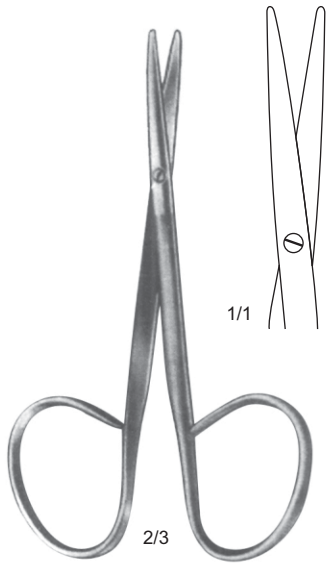

06-055-10  
10 cm / 4"

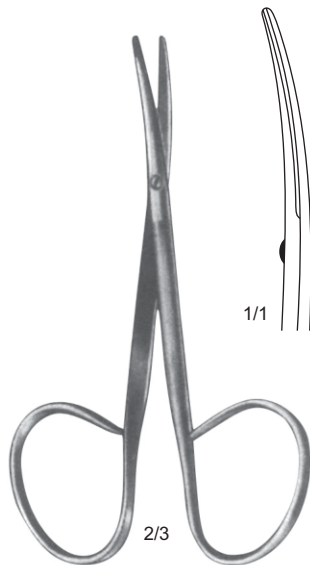

06-056-10  
10 cm / 4"

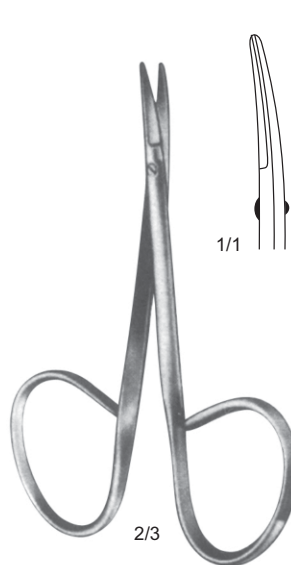

06-057-05  
9.5 cm / 3 3/4"

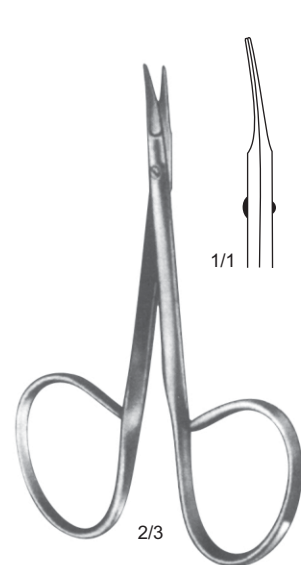

06-058-09  
9.5 cm / 3 3/4"

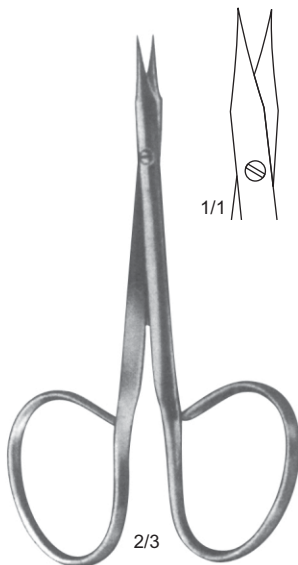

Stevens  
06-059-10  
10 cm / 4"

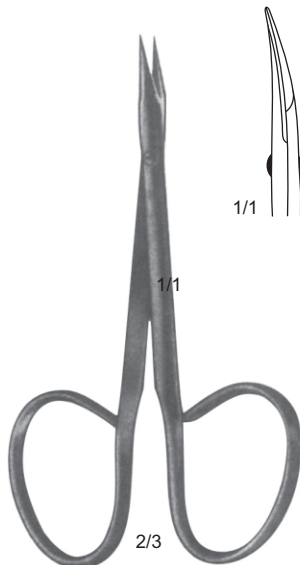

Stevens  
06-060-10  
10 cm / 4"

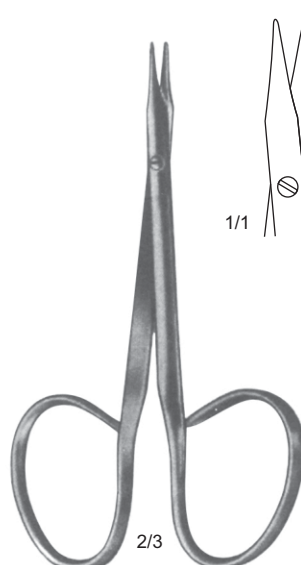

Stevens  
06-061-10  
10 cm / 4"

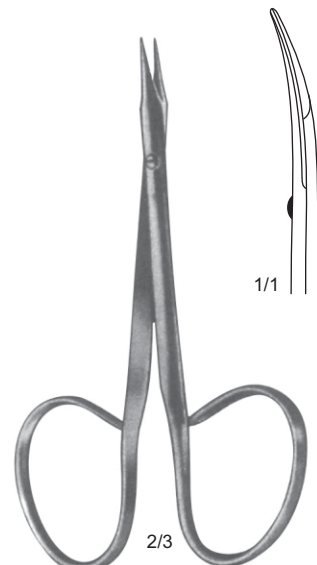

Stevens  
06-062-10  
10 cm / 4"



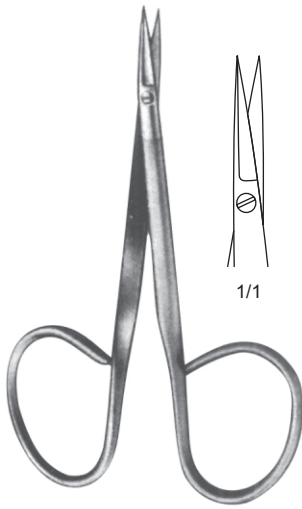

2/3  
**06-063-09**  
9.5 cm / 3 3/4"

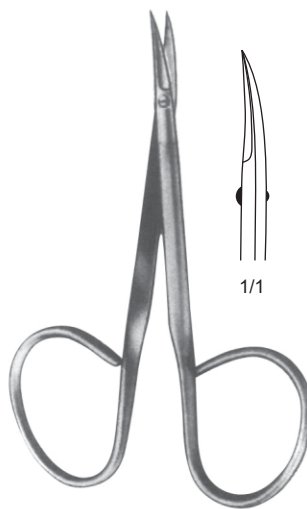

2/3  
**06-064-09**  
9.5 cm / 3 3/4"

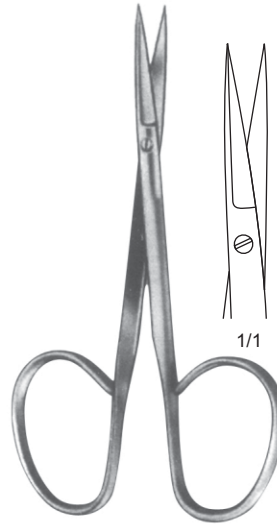

2/3  
**06-065-09**  
9.5 cm / 3 3/4"

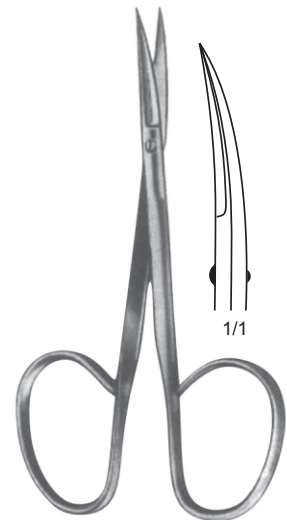

2/3  
**06-066-09**  
9.5 cm / 3 3/4"

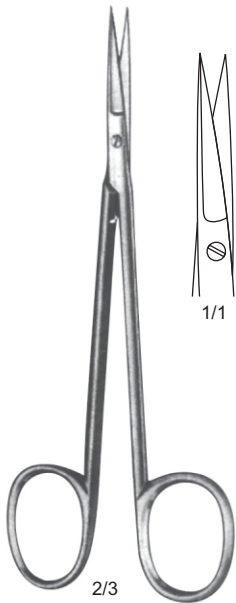

2/3  
**Knapp**  
**06-067-12**  
12 cm / 4 3/4"



2/3  
**Knapp**  
**06-068-12**  
12 cm / 4 3/4"

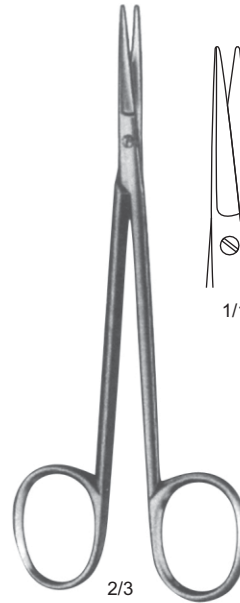

2/3  
**Knapp**  
**06-069-12**  
12 cm / 4 3/4"

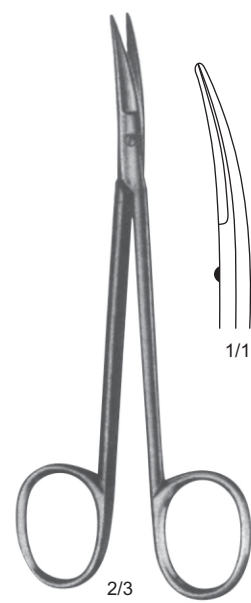

2/3  
**Knapp**  
**06-070-12**  
12 cm / 4 3/4"

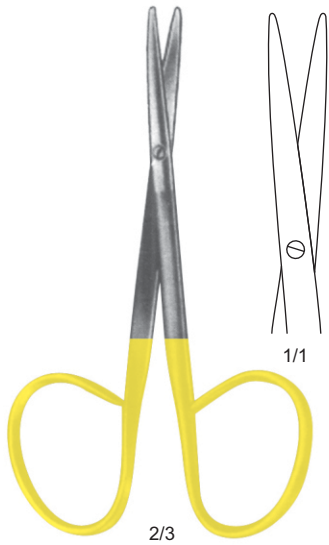

**06-071-10 TC**  
10 cm / 4"

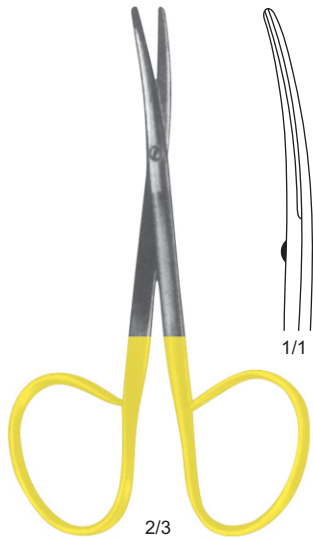

**06-072-10 TC**  
10 cm / 4"



**06-073-09 TC**  
9.5 cm / 3¾"

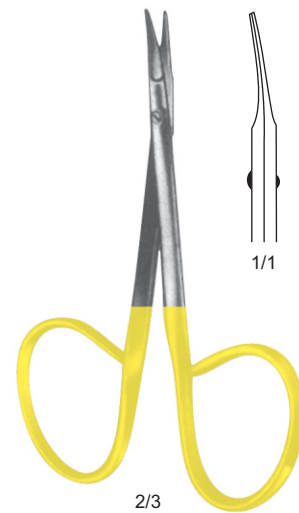

**06-074-09 TC**  
9.5 cm / 3¾"

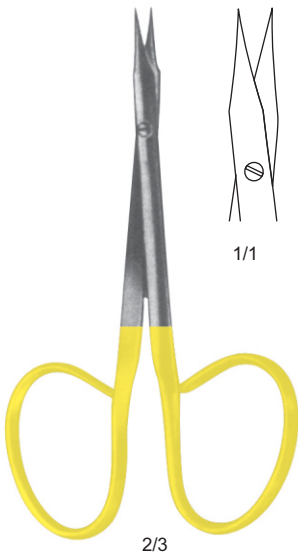

**Stevens TC**  
**06-075-10**  
10 cm / 4"

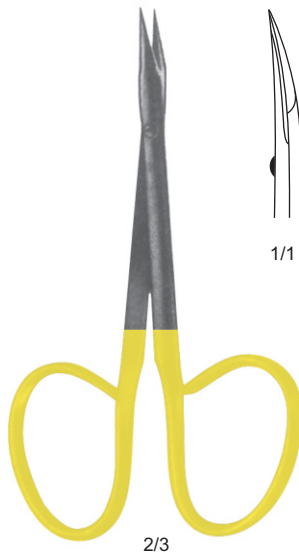

**Stevens TC**  
**06-076-10**  
10 cm / 4"

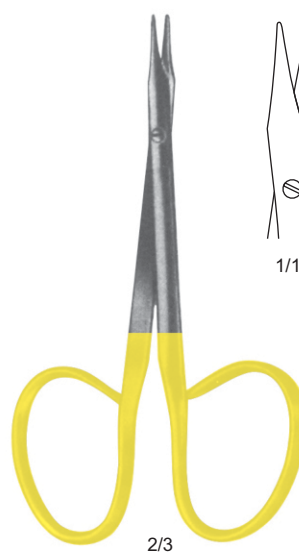

**Stevens TC**  
**06-077-10**  
10 cm / 4"

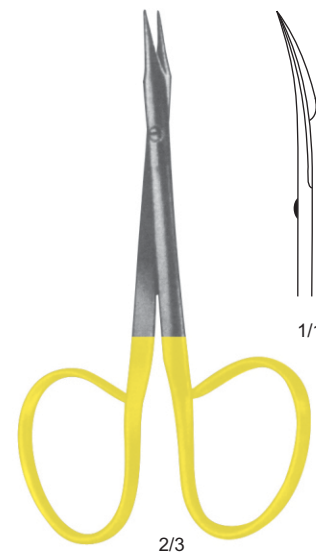

**Stevens TC**  
**06-078-10**  
10 cm / 4"



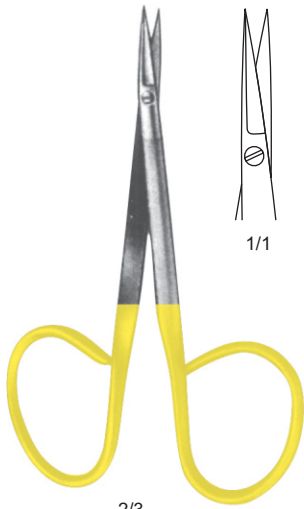

2/3  
**06-079-09 TC**  
9.5 cm / 3¾"

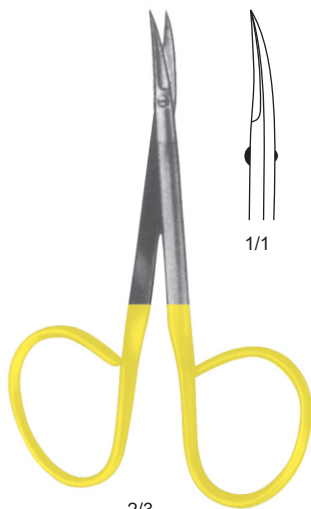

2/3  
**06-080-09 TC**  
9.5 cm / 3¾"

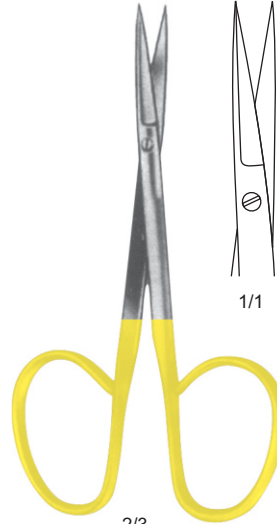

2/3  
**06-081-09 TC**  
9.5 cm / 3¾"

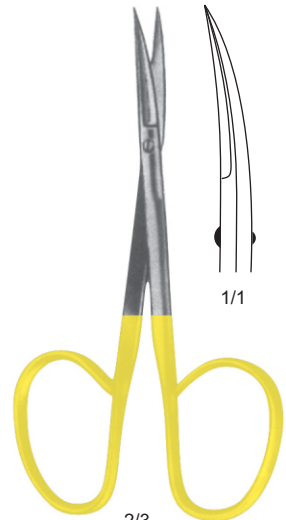

2/3  
**06-082-09 TC**  
9.5 cm / 3¾"

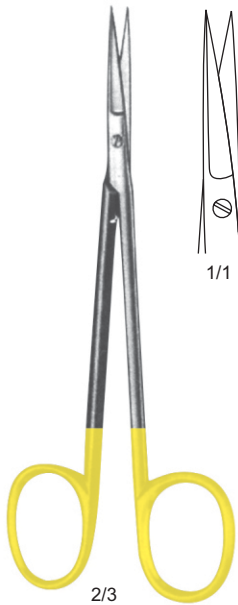

2/3  
**Knapp TC**  
**06-083-12**  
12 cm / 4¾"

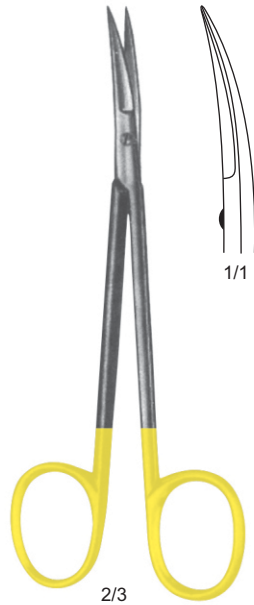

2/3  
**Knapp TC**  
**06-084-12**  
12 cm / 4¾"



2/3  
**Knapp TC**  
**06-085-12**  
12 cm / 4¾"

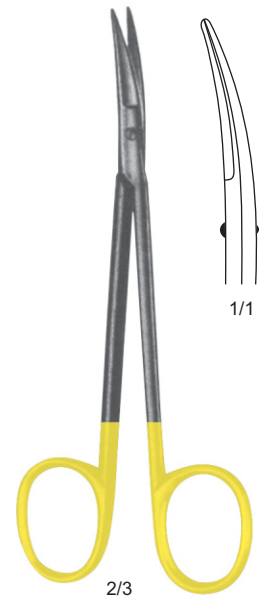

2/3  
**Knapp TC**  
**06-086-12**  
12 cm / 4¾"

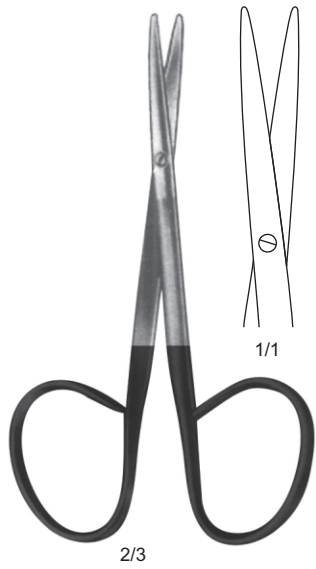

06-087-10 SC  
10 cm / 4"

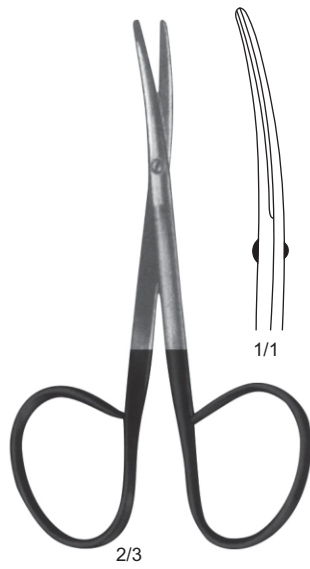

06-088-10 SC  
10 cm / 4"

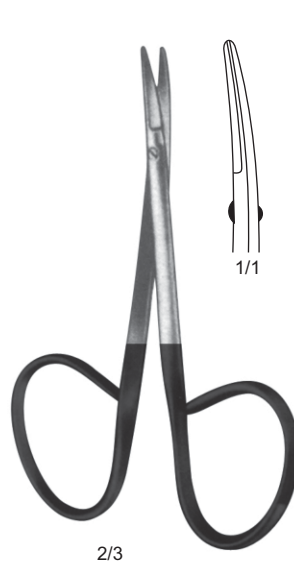

06-089-09 SC  
9.5 cm / 3 3/4"

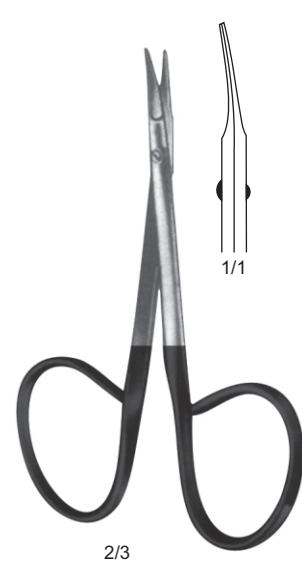

06-090-09 SC  
9.5 cm / 3 3/4"

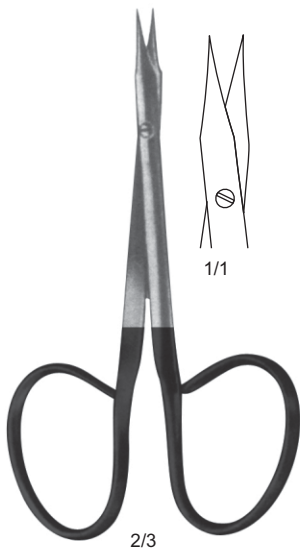

Stevens  
06-091-10 SC  
10 cm / 4"

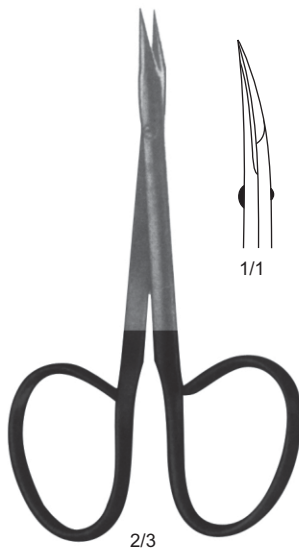

Stevens  
06-092-10 SC  
10 cm / 4"

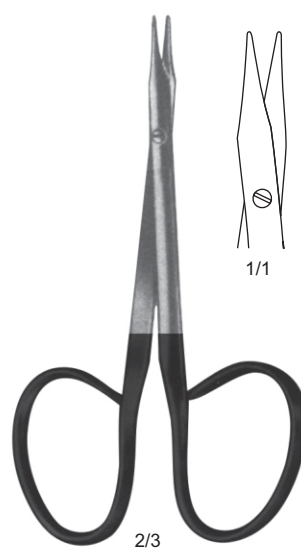

Stevens  
06-093-10 SC  
10 cm / 4"

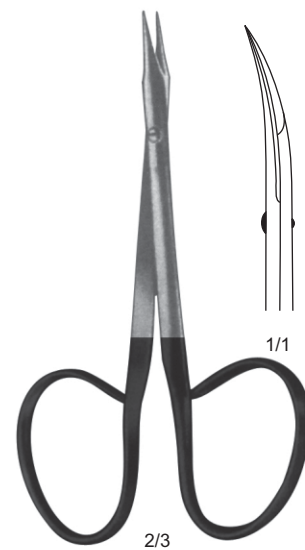

Stevens  
06-094-10 SC  
10 cm / 4"



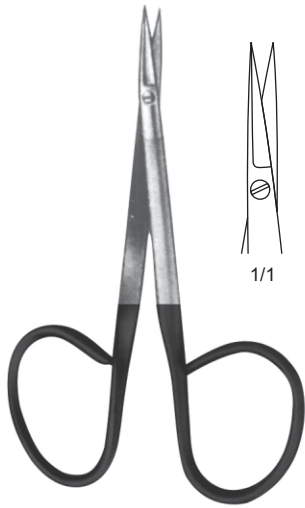

2/3  
**06-095-09 SC**  
9.5 cm / 3¾"

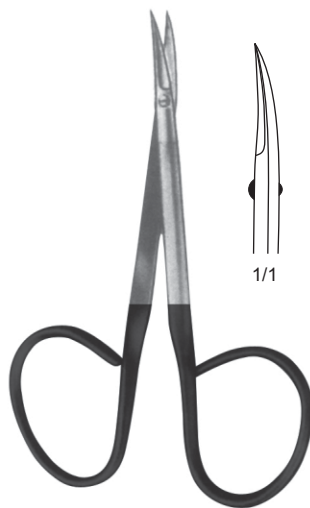

2/3  
**06-096-09 SC**  
9.5 cm / 3¾"

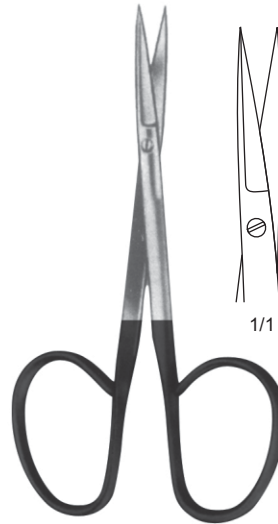

2/3  
**06-097-09 SC**  
9.5 cm / 3¾"

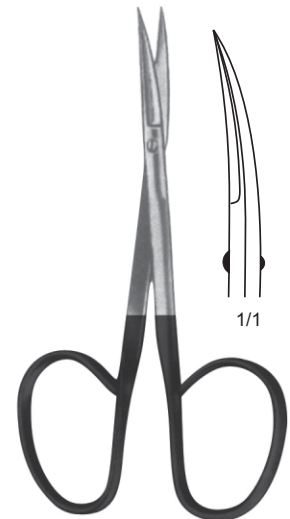

2/3  
**06-098-09 SC**  
9.5 cm / 3¾"

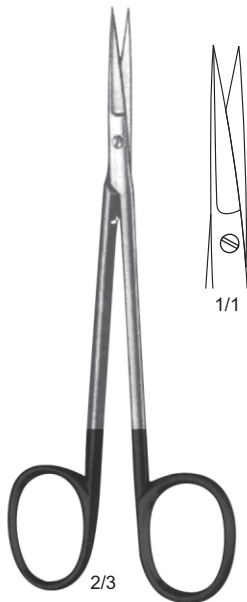

2/3  
**Knapp SC**  
**06-099-12**  
12 cm / 4¾"



2/3  
**Knapp SC**  
**06-100-12**  
12 cm / 4¾"

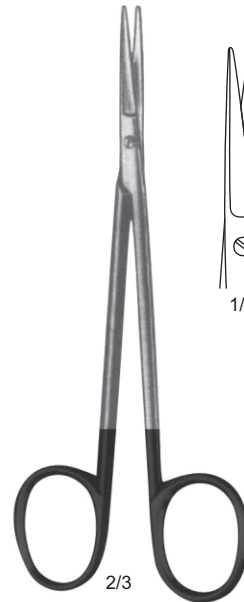

2/3  
**Knapp SC**  
**06-101-12**  
12 cm / 4¾"

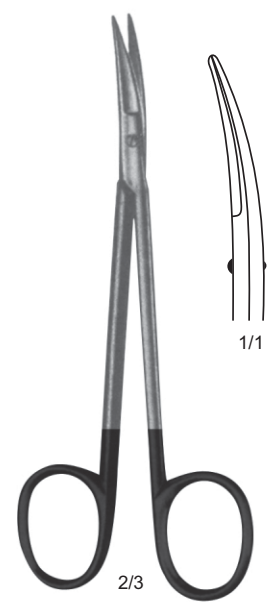

2/3  
**Knapp SC**  
**06-102-12**  
12 cm / 4¾"



**Micro-Castroviejo**  
With out lock  
9.5 cm / 3½"



**Micro-Castroviejo**  
With lock  
9.5 cm / 3½"

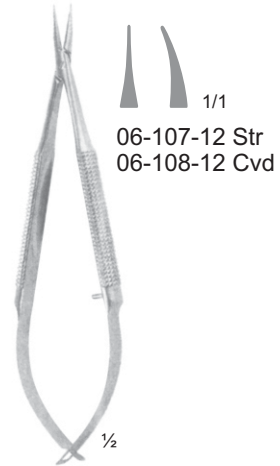

**Barraquer**  
Without lock  
12 cm / 4¾"



**Micro-Castroviejo TC**  
With out lock  
14 cm / 5½"



**Micro-Castroviejo TC**  
With lock  
14 cm / 5½"

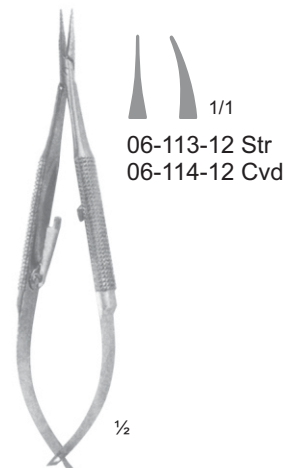

**Barraquer**  
With lock  
12 cm / 4¾"



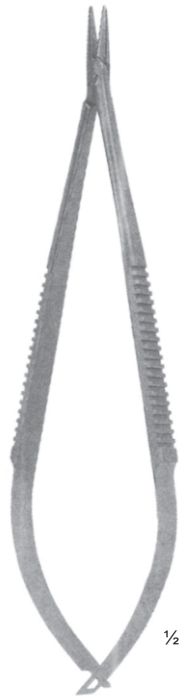

**Castroviejo**  
Without lock  
18 cm / 7"

Delicate 1/1

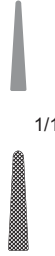

- 06-115-14 14 cm / 5½" Str/Smooth
- 06-115-18 18 cm / 7" Str/Smooth
- 06-115-21 21 cm / 8¼" Str/Smooth
- 06-115-23 23 cm / 8¾" Str/Smooth
- 06-116-14 14 cm / 5½" Str/Serrated
- 06-116-18 18 cm / 7" Str/Serrated
- 06-116-21 21 cm / 8¼" Str/Serrated
- 06-116-23 23 cm / 8¾" Str/Serrated

Micro 1/1



- 06-117-14 14 cm / 5½" Cvd/Smooth
- 06-117-18 18 cm / 7" Cvd/Smooth
- 06-117-21 21 cm / 8¼" Cvd/Smooth
- 06-117-23 23 cm / 8¾" Cvd/Smooth
- 06-118-14 14 cm / 5½" Cvd/Serrated
- 06-118-18 18 cm / 7" Cvd/Serrated
- 06-118-21 21 cm / 8¼" Cvd/Serrated
- 06-118-23 23 cm / 8¾" Cvd/Serrated



**Castroviejo**  
With lock  
18 cm / 7"

Delicate 1/1



- 06-119-14 14 cm / 5½" Str/Smooth
- 06-119-18 18 cm / 7" Str/Smooth
- 06-119-21 21 cm / 8¼" Str/Smooth
- 06-119-23 23 cm / 8¾" Str/Smooth
- 06-120-14 14 cm / 5½" Str/Serrated
- 06-120-18 18 cm / 7" Str/Serrated
- 06-120-21 21 cm / 8¼" Str/Serrated
- 06-120-23 23 cm / 8¾" Str/Serrated

Micro 1/1



- 06-121-14 14 cm / 5½" Cvd/Smooth
- 06-121-18 18 cm / 7" Cvd/Smooth
- 06-121-21 21 cm / 8¼" Cvd/Smooth
- 06-121-23 23 cm / 8¾" Cvd/Smooth
- 06-122-14 14 cm / 5½" Cvd/Serrated
- 06-122-18 18 cm / 7" Cvd/Serrated
- 06-122-21 21 cm / 8¼" Cvd/Serrated
- 06-122-23 23 cm / 8¾" Cvd/Serrated





**Barraquer**  
Without lock  
23 cm / 9"



1/1  
Delicate



1/1  
Micro

- 06-123-14 14 cm / 5½" Str
- 06-123-16 16 cm / 6" Str
- 06-123-18 18 cm / 7" Str
- 06-123-21 21 cm / 8¼" Str
- 06-123-23 23 cm / 8¾" Str
- 06-124-14 14 cm / 5½" Cvd
- 06-124-16 16 cm / 6" Cvd
- 06-124-18 18 cm / 7" Cvd
- 06-124-21 21 cm / 8¼" Cvd
- 06-124-23 23 cm / 8¾" Cvd

- 06-123-14 14 cm / 5½" Str
- 06-123-16 16 cm / 6" Str
- 06-123-18 18 cm / 7" Str
- 06-123-21 21 cm / 8¼" Str
- 06-123-23 23 cm / 8¾" Str
- 06-124-14 14 cm / 5½" Cvd
- 06-124-16 16 cm / 6" Cvd
- 06-124-18 18 cm / 7" Cvd
- 06-124-21 21 cm / 8¼" Cvd
- 06-124-23 23 cm / 8¾" Cvd



**Barraquer**  
With lock  
23 cm / 9"



1/1  
Delicate



1/1  
Micro

- 06-127-14 14 cm / 5½" Str
- 06-127-15 15 cm / 6" Str
- 06-127-18 18 cm / 7" Str
- 06-127-21 21 cm / 8¼" Str
- 06-127-23 23 cm / 8¾" Str
- 06-128-14 14 cm / 5½" Cvd
- 06-128-15 15 cm / 6" Cvd
- 06-128-18 18 cm / 7" Cvd
- 06-128-21 21 cm / 8¼" Cvd
- 06-128-23 23 cm / 8¾" Cvd

- 06-129-14 14 cm / 5½" Str
- 06-129-15 15 cm / 6" Str
- 06-129-18 18 cm / 7" Str
- 06-129-21 21 cm / 8¼" Str
- 06-129-23 23 cm / 8¾" Str
- 06-130-14 14 cm / 5½" Cvd
- 06-130-15 15 cm / 6" Cvd
- 06-130-18 18 cm / 7" Cvd
- 06-130-21 21 cm / 8¼" Cvd
- 06-130-23 23 cm / 8¾" Cvd





**Castroviejo TC**  
Without lock  
18 cm / 7"

- 06-131-14 14 cm / 5½" Str
- 06-131-18 18 cm / 7" Str
- 06-131-21 21 cm / 8¼" Str
- 06-131-23 23 cm / 8¾" Str
- 06-132-14 14 cm / 5¼" Cvd
- 06-132-18 18 cm / 7" Cvd
- 06-132-21 21 cm / 8¼" Cvd
- 06-132-23 23 cm / 8¾" Cvd



**Castroviejo TC**  
With lock  
18.0 cm / 7"

- 06-133-14 14 cm / 5½" Str
- 06-133-18 18 cm / 7" Str
- 06-133-21 21 cm / 8¼" Str
- 06-133-23 23 cm / 8¾" Str
- 06-134-14 14 cm / 5¼" Cvd
- 06-134-18 18 cm / 7" Cvd
- 06-134-21 21 cm / 8¼" Cvd
- 06-134-23 23 cm / 8¾" Cvd



**Barraquer TC**  
With lock  
23 cm / 9"



1/1  
Delicate

- 06-135-14 14 cm / 5½" Str
- 06-135-15 15 cm / 6" Str
- 06-135-18 18 cm / 7" Str
- 06-135-21 21 cm / 8¾" Str
- 06-135-23 23 cm / 8¾" Str
- 06-136-14 14 cm / 5½" Cvd
- 06-136-15 15 cm / 6" Cvd
- 06-136-18 18 cm / 7" Cvd
- 06-136-21 21 cm / 8¾" Cvd
- 06-136-23 23 cm / 8¾" Cvd



1/1  
Micro

- 06-137-14 14 cm / 5½" Str
- 06-137-15 15 cm / 6" Str
- 06-137-18 18 cm / 7" Str
- 06-137-21 21 cm / 8¾" Str
- 06-137-23 23 cm / 8¾" Str
- 06-138-14 14 cm / 5½" Cvd
- 06-138-15 15 cm / 6" Cvd
- 06-138-18 18 cm / 7" Cvd
- 06-138-21 21 cm / 8¾" Cvd
- 06-138-23 23 cm / 8¾" Cvd

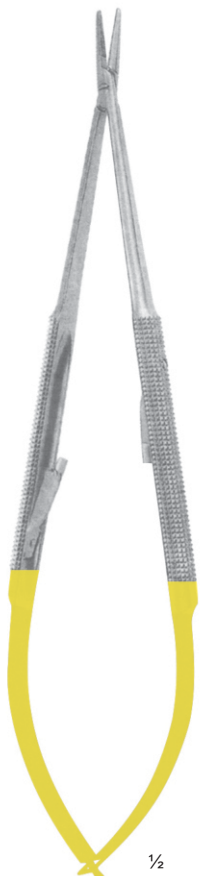

**Barraquer TC**  
With lock  
23 cm / 9"



1/1  
Delicate

- 06-139-14 14 cm / 5½" Str
- 06-139-15 15 cm / 6" Str
- 06-139-18 18 cm / 7" Str
- 06-139-21 21 cm / 8¾" Str
- 06-139-23 23 cm / 8¾" Str
- 06-140-14 14 cm / 5½" Cvd
- 06-140-15 15 cm / 6" Cvd
- 06-140-18 18 cm / 7" Cvd
- 06-140-21 21 cm / 8¾" Cvd
- 06-140-23 23 cm / 8¾" Cvd



1/1  
Micro

- 06-141-14 14 cm / 5½" Str
- 06-141-15 15 cm / 6" Str
- 06-141-18 18 cm / 7" Str
- 06-141-21 21 cm / 8¾" Str
- 06-141-23 23 cm / 8¾" Str
- 06-142-14 14 cm / 5½" Cvd
- 06-142-15 15 cm / 6" Cvd
- 06-142-18 18 cm / 7" Cvd
- 06-142-21 21 cm / 8¾" Cvd
- 06-142-23 23 cm / 8¾" Cvd



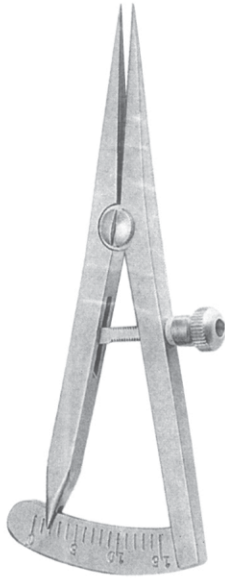

**Castroviejo**  
06-143-01 15 mm Str  
06-143-02 15 mm Str with teflon  
06-143-03 15 mm Cvd  
06-143-04 15 mm Cvd with teflon

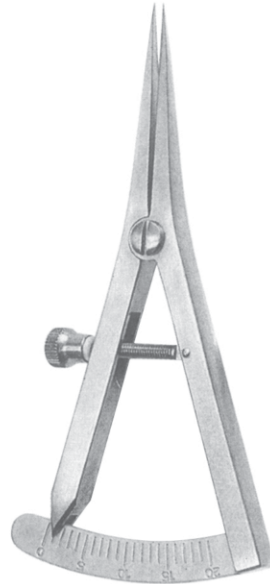

**Castroviejo**  
06-144-01 20 cm Str  
06-144-02 20 cm Str with teflon  
06-144-03 20 cm Cvd  
06-144-04 20 cm Cvd with teflon

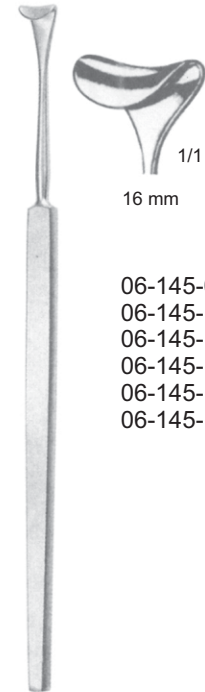

06-145-08 8 mm  
06-145-10 10 mm  
06-145-12 12 mm  
06-145-14 14 mm  
06-145-16 16 mm  
06-145-18 18 mm

**Desmarres**  
Eye Retractor

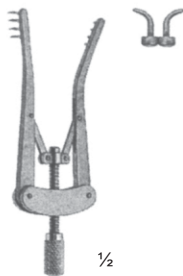

**ALM**  
4x4 prongs  
7 cm / 2¾"

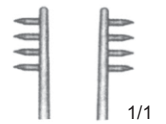

06-146-07 Sharp

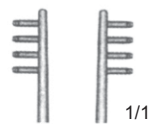

06-147-07 Blunt



**ALM**  
4x4 prongs  
10 cm / 4"



06-148-10 Sharp

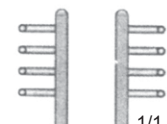

06-149-10 Blunt



### 초음파 세척기가 없는 세척방법 (손세척방법)

거품이 적게 발생하는 중성 pH(6-8.5)세제를 이용하여 부드러운 솔과 스폰지를 사용하여 손으로 의료기를 세척하세요.

렌즈가 달린 의료기구는. pH가 너무 알칼리성이거나 너무 산성이면 얼룩이나 구멍이 생길 수 있습니다.

의료기구는. 강모의 솔이나, 연마제를 사용하면 안 됩니다 약모의 브러쉬나 스폰지를 물에 잠긴 의료기구와 함께 사용해야 합니다.

의료기구는 증류수 또는 탈염수로 헹구어야 합니다.

그런 다음 보푸라기가 없는 천이나 뜨거운 공기로 건조시킵니다. 세척을 위해 식염수 대신 증류수를 사용하거나 헹굼 도구를 사용하면 의료기구의 수명을 수년 연장할 수 있습니다.

의료기구에 표시되어 있는 검은 글자는 레이저



빈 관형(루멘) 품목을 세척할 때는 가는 브러쉬를 이용하여 중성 pH(6-8.5)세제를 사용하여 부드러운 브러쉬로 세척합니다.



[www.krnano.com](http://www.krnano.com)

성형외과

PLASTIC SURGERY

Page 118 - 130

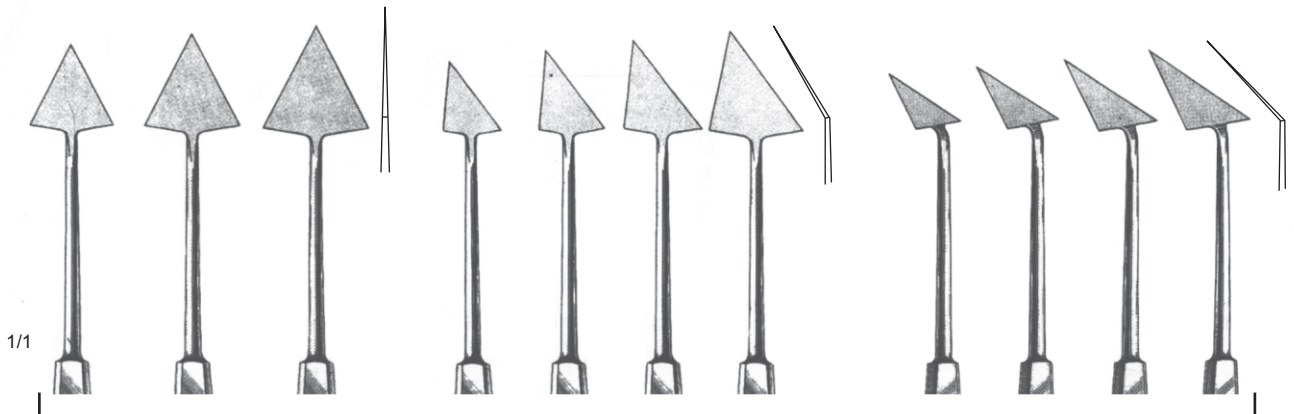

Jaeger

- 07-001-01    02    03    04    05    06    07    08 45°    09 45°    10 45°    11 45°

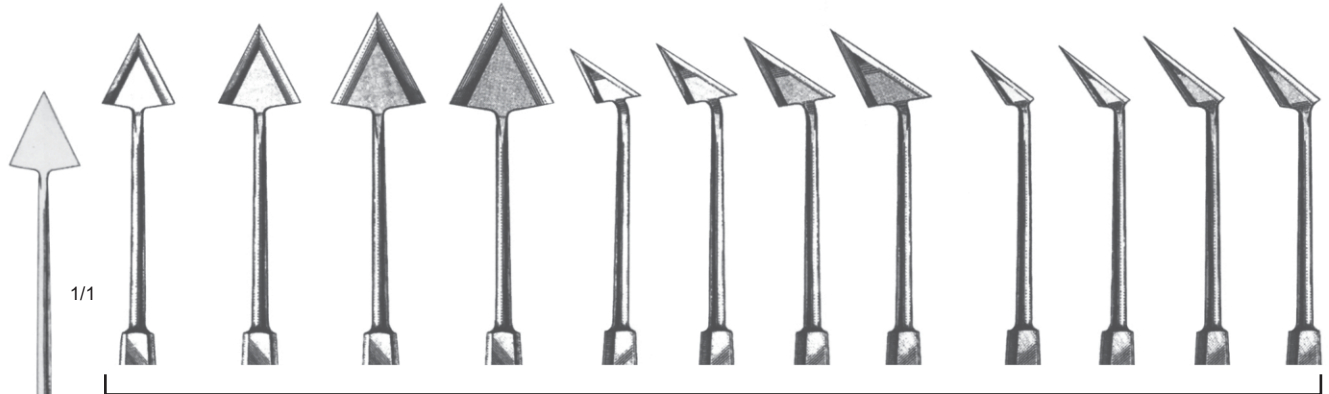

Jaeger-Grieshaber

- 12    13    14    15    16 45°    17 45°    18 45°    19 45°    20 45°    21 45°    22 45°    23 45°

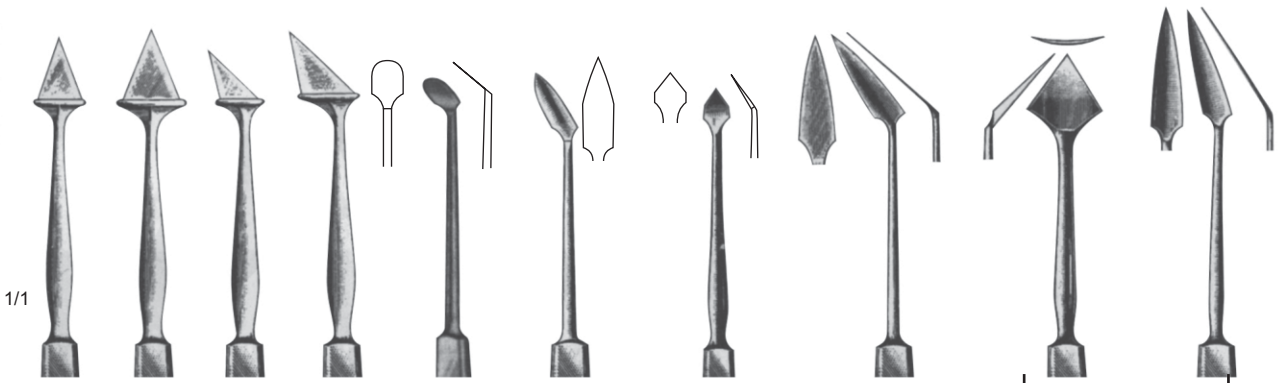

- 24    Weeker 25    26    27    Papst 28    Castroviejo 29    Rowland 30    Weiner 31    Berens 32    33

Gsger  
07-011-01 - 07-001-33



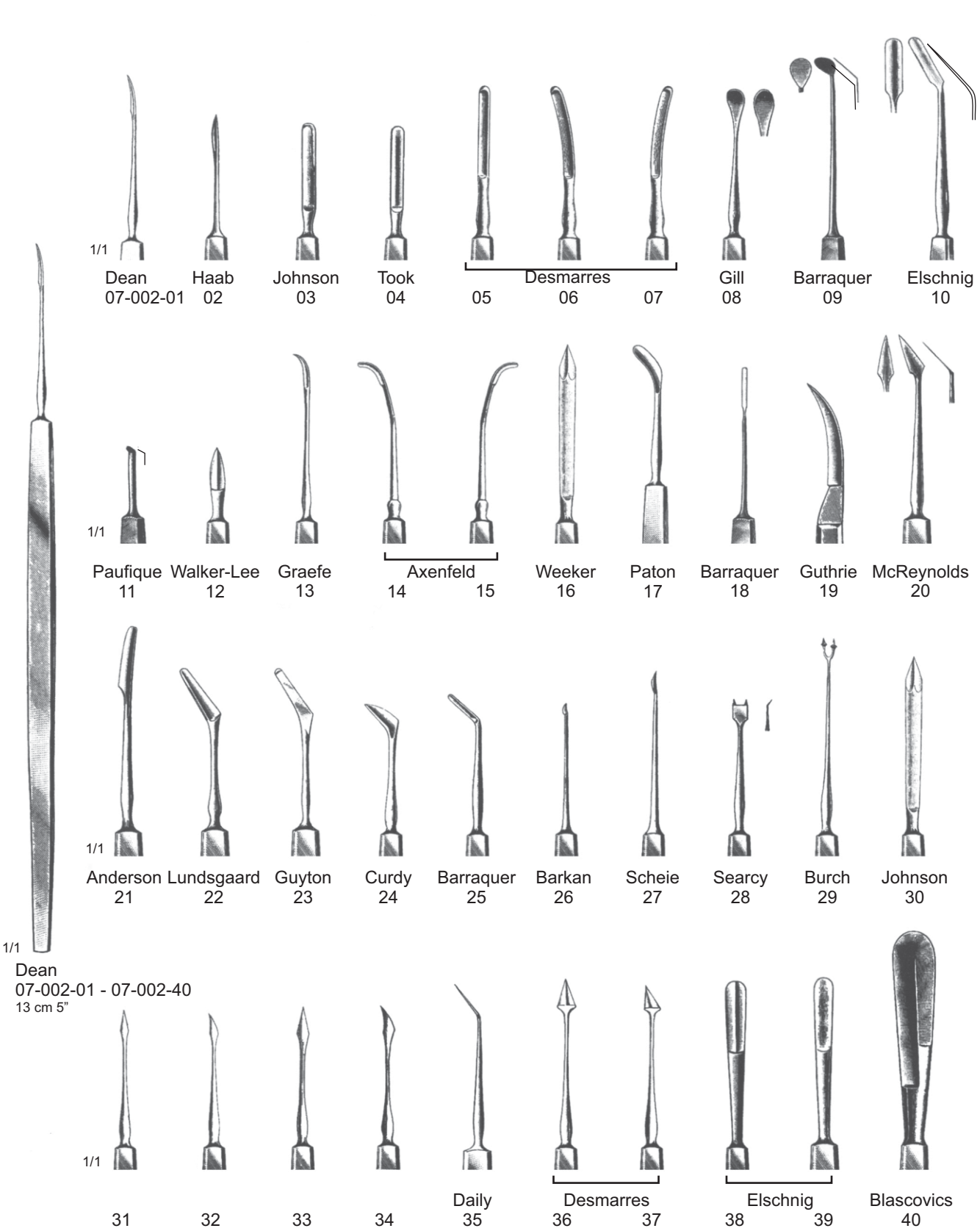

1/1

1/1

1/1

1/1

Dean 07-002-01    Haab 02    Johnson 03    Took 04    Desmarres 05    Desmarres 06    Desmarres 07    Gill 08    Barraquer 09    Elschmig 10

Paufique 11    Walker-Lee 12    Graefe 13    Axenfeld 14    Axenfeld 15    Weeker 16    Paton 17    Barraquer 18    Guthrie 19    McReynolds 20

Anderson 21    Lundsgaard 22    Guyton 23    Curdy 24    Barraquer 25    Barkan 26    Scheie 27    Searcy 28    Burch 29    Johnson 30

Dean 07-002-01 - 07-002-40 13 cm 5"

31    32    33    34    Daily 35    Desmarres 36    Desmarres 37    Elschmig 38    Elschmig 39    Blascovics 40





1/1  
07-003-01  
07-003-37  
12 cm 4%

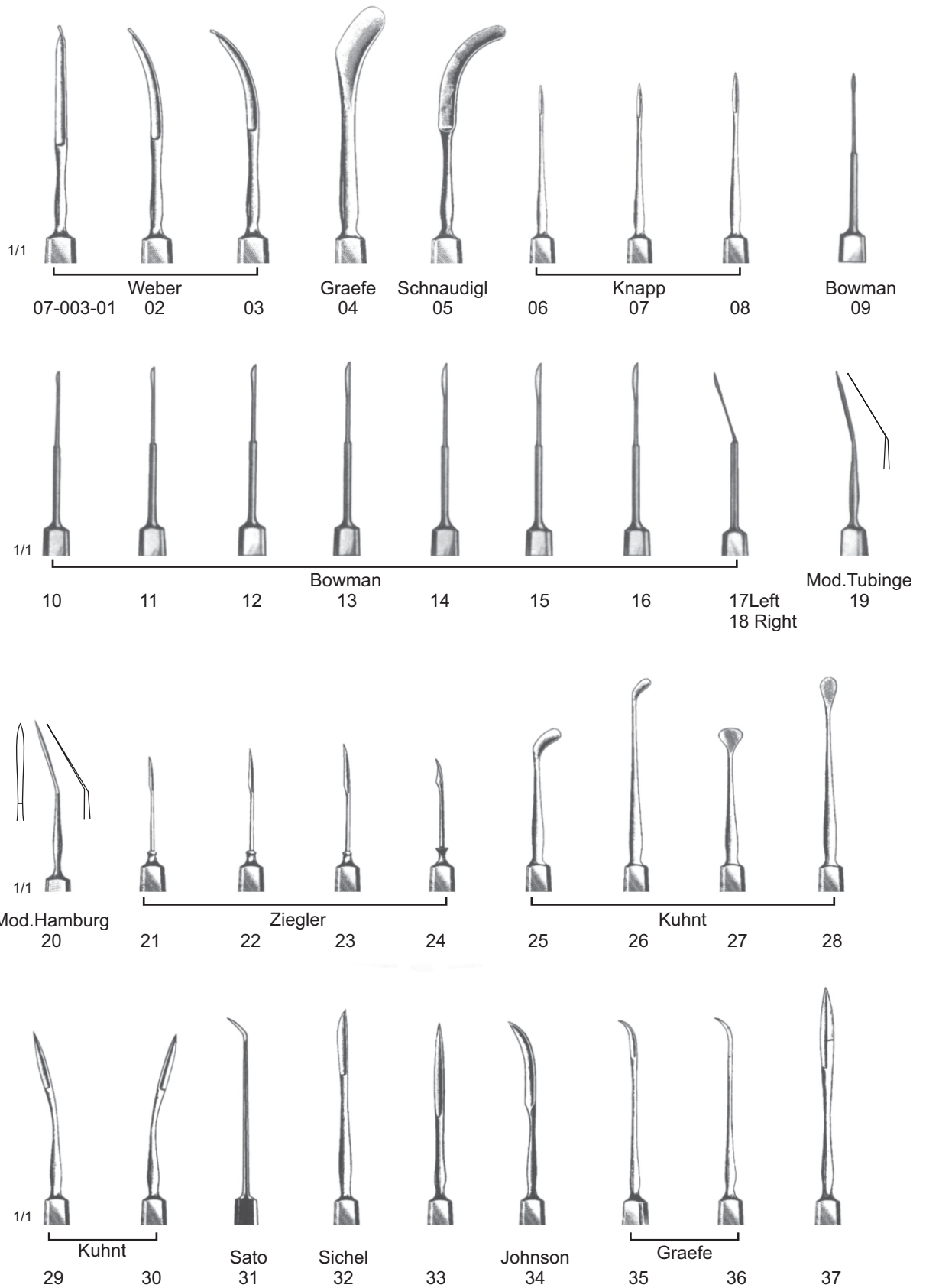

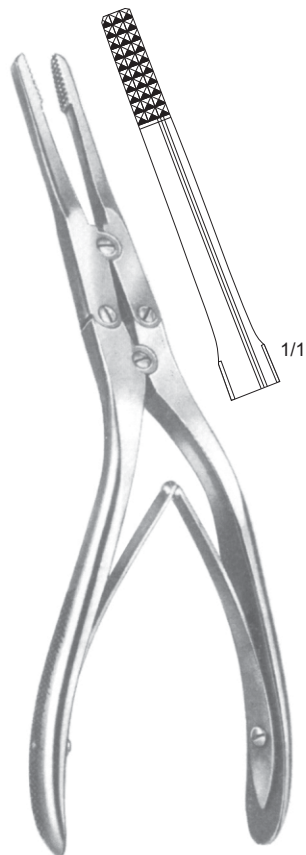

Rubin  
07-004-21  
21 cm / 18.5"



Cottle Kazanjian  
07-005-19  
19 cm / 7 1/2"

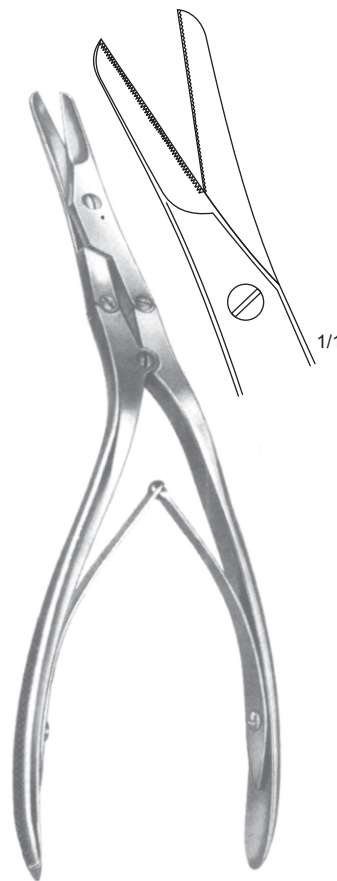

Calpan  
07-006-20  
20 cm / 8"



Gorney  
07-007-12 - 07-008-09

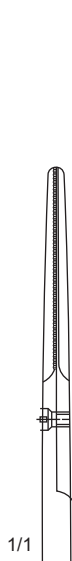

07-007-12  
12.5 cm / 5"

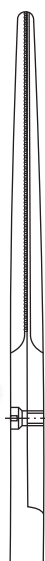

07-007-19  
19.5 cm / 7 3/4"

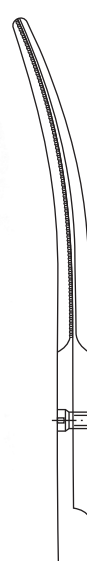

07-008-19  
19.5 cm / 7 3/4"



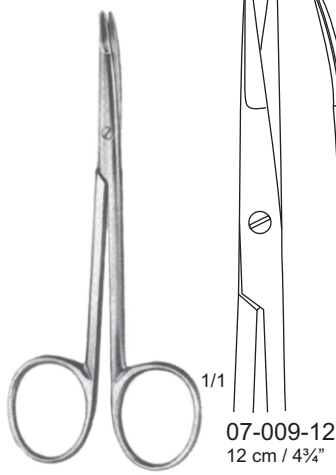

07-009-12  
12 cm / 4¾"

½  
**Kilner**  
07-009-12 - 07-009-15

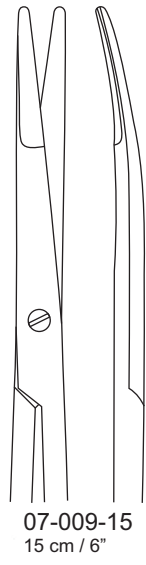

07-009-15  
15 cm / 6"

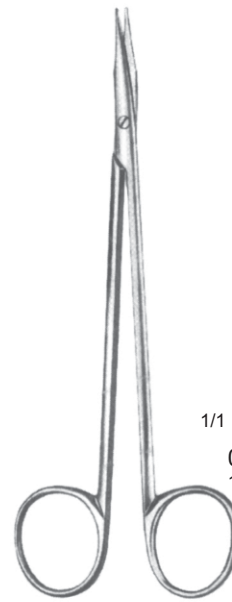

1/1  
07-010-15  
15 cm / 6"

½  
**Reynolds SC**  
07-010-15 - 07-111-15

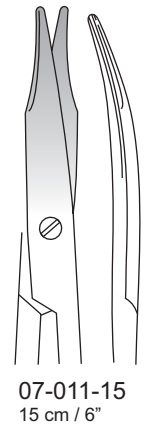

07-011-15  
15 cm / 6"

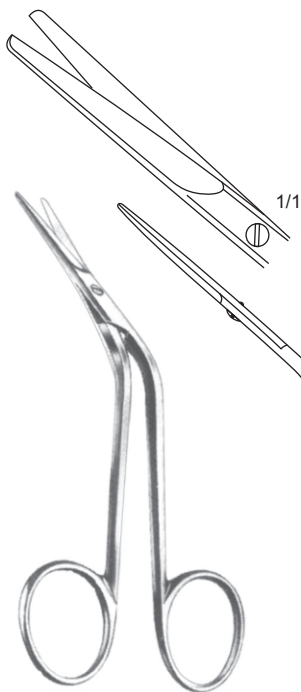

**Fomon SC**  
07-012-15  
15 cm / 6"

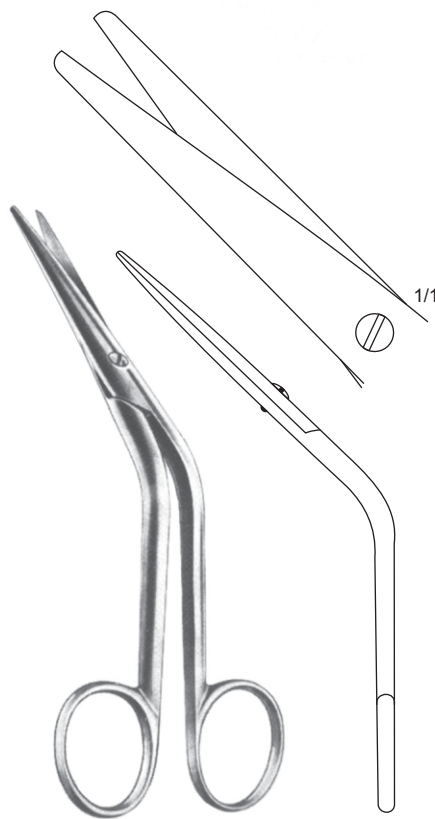

**Cottle**  
07-013-16  
16 cm / 6½"

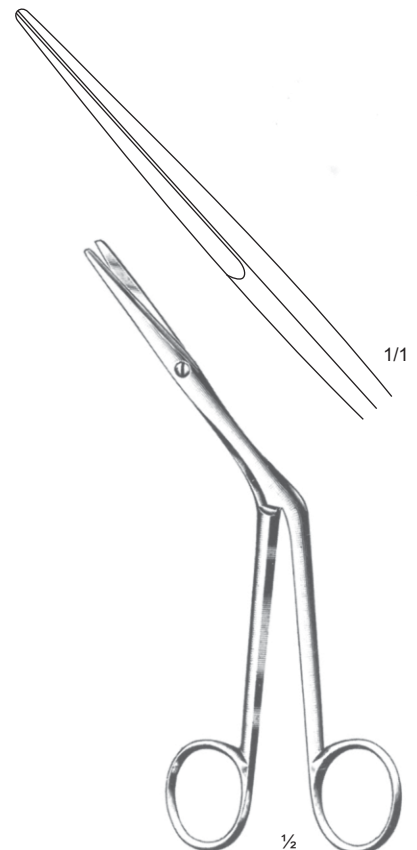

½  
**Heymann-Knight**  
07-014-18  
18 cm / 7"

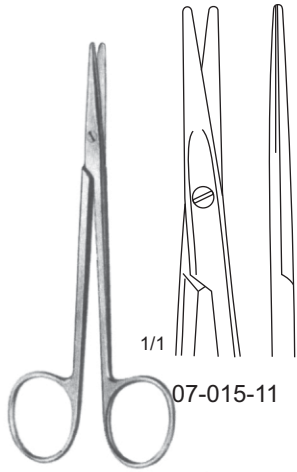

1/2  
**Strabismus**  
11 cm / 4 1/2"  
07-015-11-07-016-11

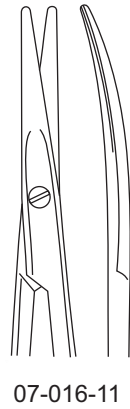

07-016-11

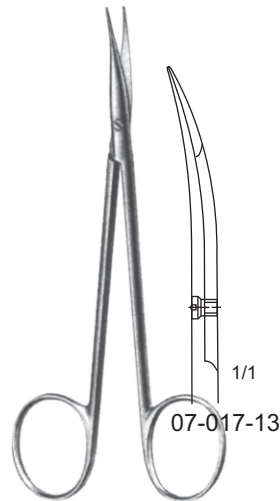

1/2  
**Jameson**  
13 cm / 5"

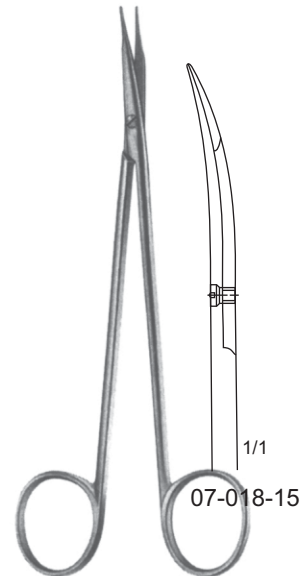

1/2  
**Jameson**  
15 cm / 6"

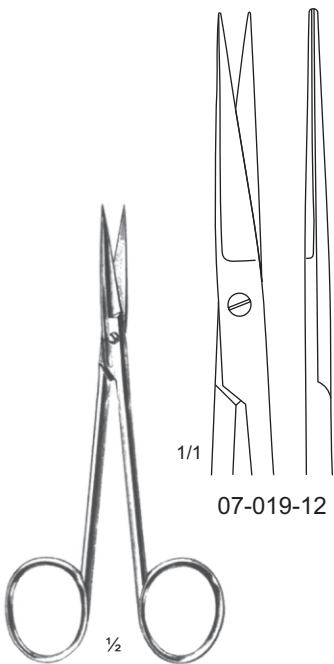

1/2  
**Wagner**  
12 cm / 4 3/4"  
07-019-12-07-020-12

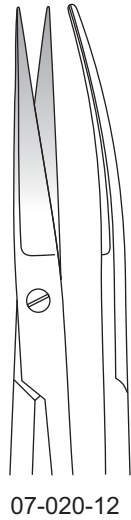

07-020-12

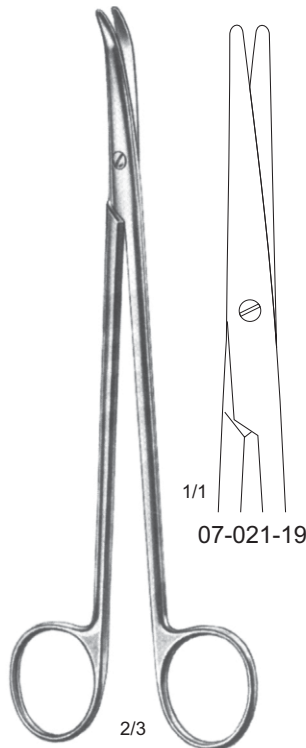

2/3  
**Thorek**  
19 cm / 7 1/2"

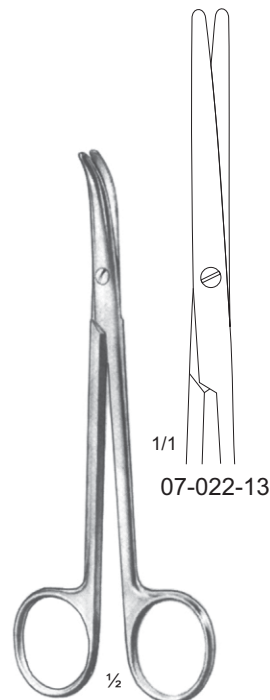

1/2  
**Fomon**  
13.5 cm / 5 1/4"



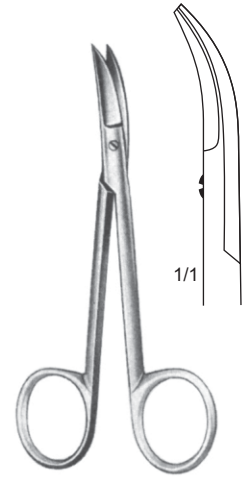

Quinby  
07-023-12  
12.5 cm / 4 3/4"

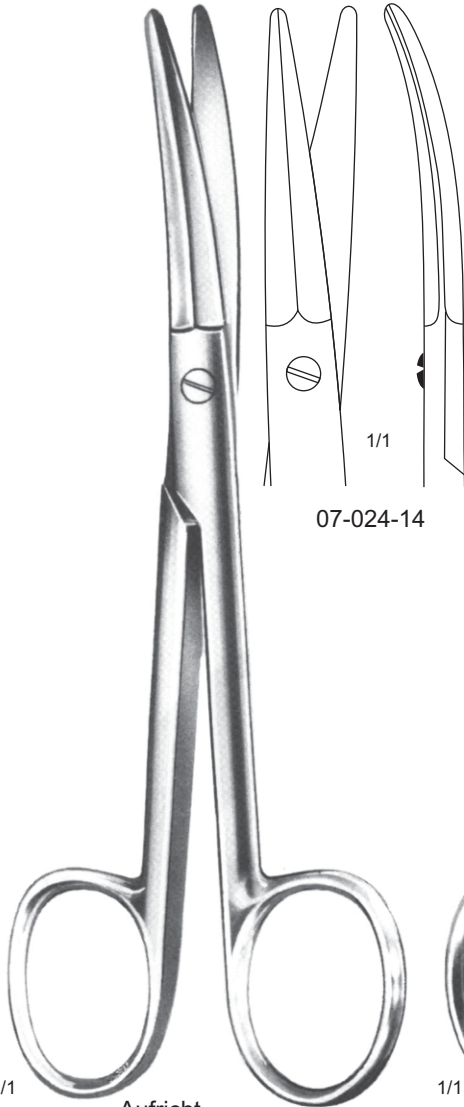

07-024-14

1/1  
Aufricht  
14.5 cm / 5 3/4"

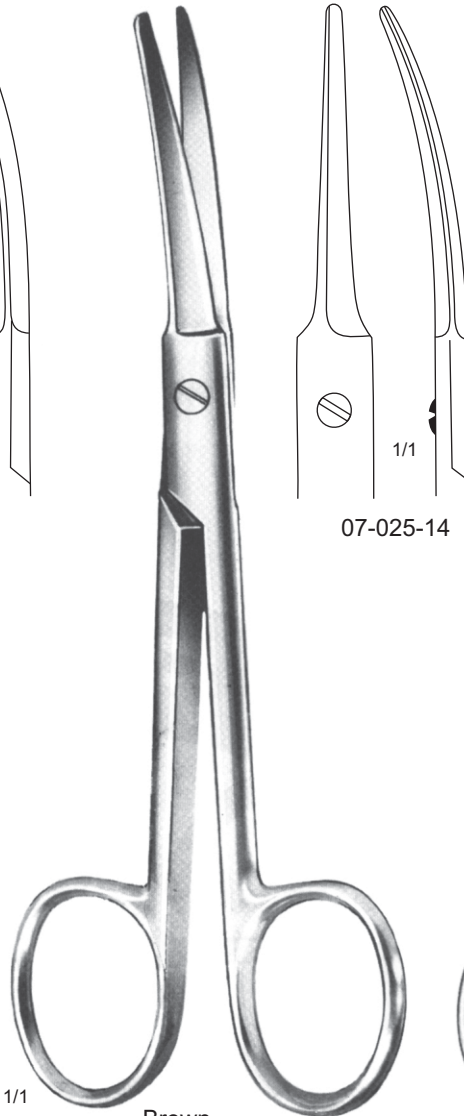

07-025-14

1/1  
Brown  
14.5 cm / 5 3/4"

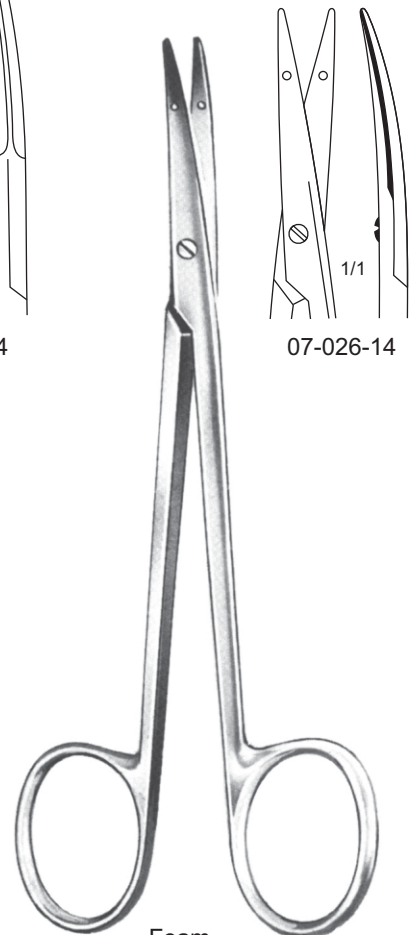

07-026-14

1/1  
Foam  
14.5 cm / 5"



1/1  
07-027-15    07-028-15    07-029-15    07-030-15



1/2  
**Joseph**  
15 cm / 6"  
07-027-15 - 07-030-15

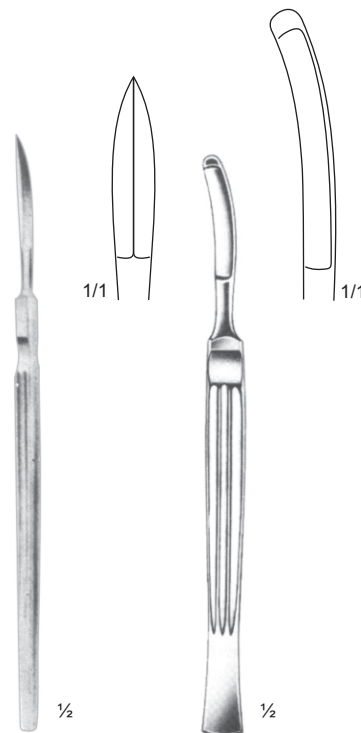

1/2                      1/2  
**Fomon**                      **Converse**  
07-031-16                      07-032-16  
16 cm / 6 1/2"                      16 cm / 6 1/2"

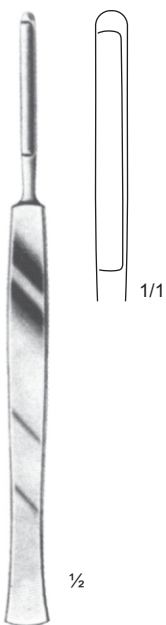

1/2  
**Joseph**  
07-033-15  
15 cm / 6"



1/2  
**Joseph**  
07-034-15  
15 cm / 6"

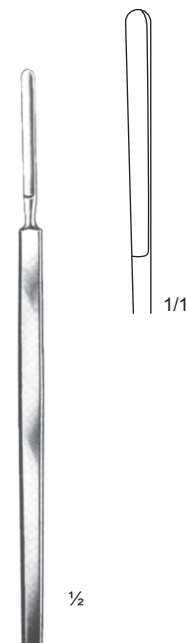

1/2  
07-035-15





**Lange**  
07-036-22  
21 cm / 8 3/4"



**Joseph**  
07-037-16  
16 cm / 6 1/4"



**Joseph**  
07-037-02 - 07-037-10  
16 cm / 6 1/4"



1/1  
07-037-02  
2 mm



1/1  
07-037-05  
5 mm



1/1  
07-037-07  
7 mm



1/1  
07-037-10  
10 mm



**Kleinert**  
07-038-01 - 07-038-13  
16 cm / 6 1/4"



1/1  
07-038-01



07-038-02



1/1  
07-038-03



07-039-01 - 07-039-04  
14 cm / 5 1/2"

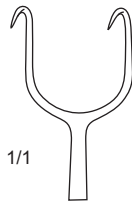

1/1  
07-039-01



07-039-02



1/1  
07-039-03



07-039-04



**Lahey**  
07-040-01 - 07-040-03  
12.5 cm / 4 3/4"



1/1  
07-040-01



1/1  
07-040-02



1/1  
07-040-03



07-040-04  
12.5 cm / 4 3/4"



1/1  
**Blunt**

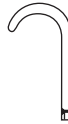

1/1





Converse  
07-041-18  
18 cm / 7"



Converse  
07-042-18  
18 cm / 7"



Gillies  
07-043-18  
18 cm / 7"



Kilner  
07-044-15  
15 cm / 6"



Converse  
07-045-12  
12.5 cm / 4 3/4"



Lange  
07-046-17  
17 cm / 6 3/4"



Fomon  
07-047-16  
16 cm / 6 1/4"

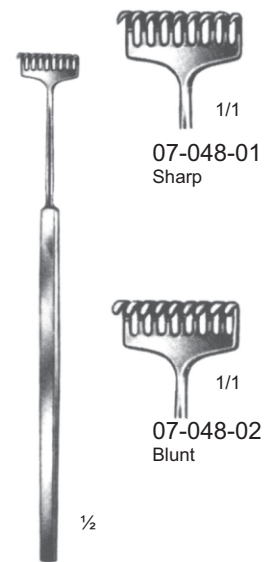

Miller  
13.5 cm / 5 1/4"



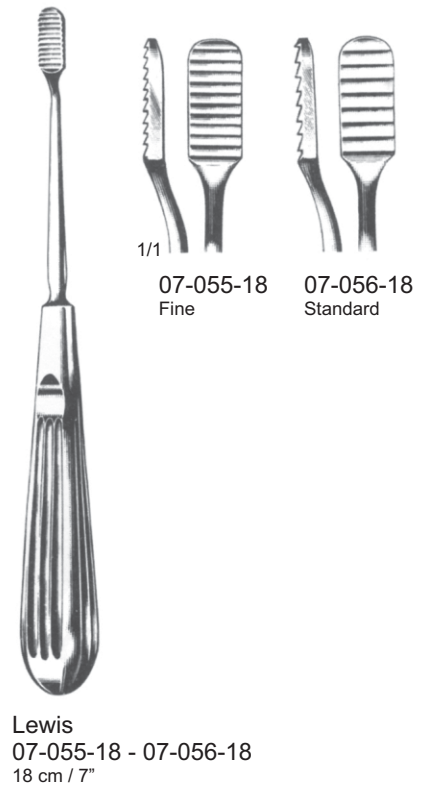
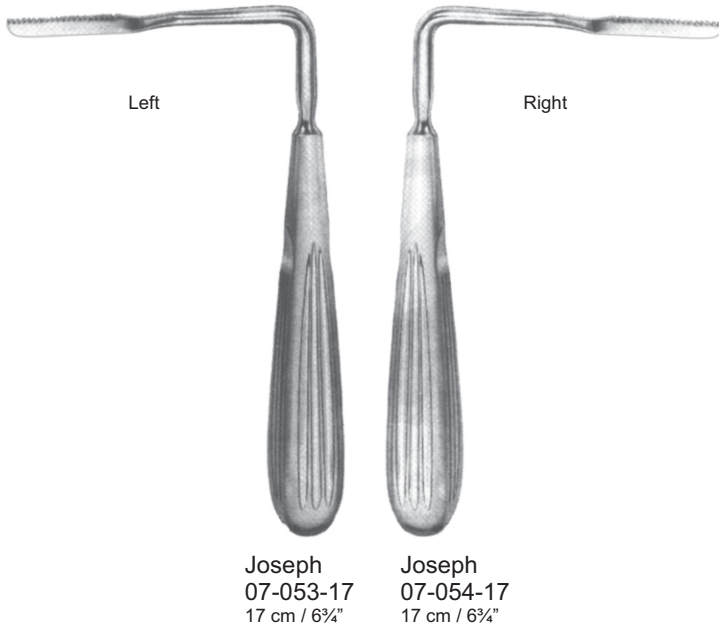
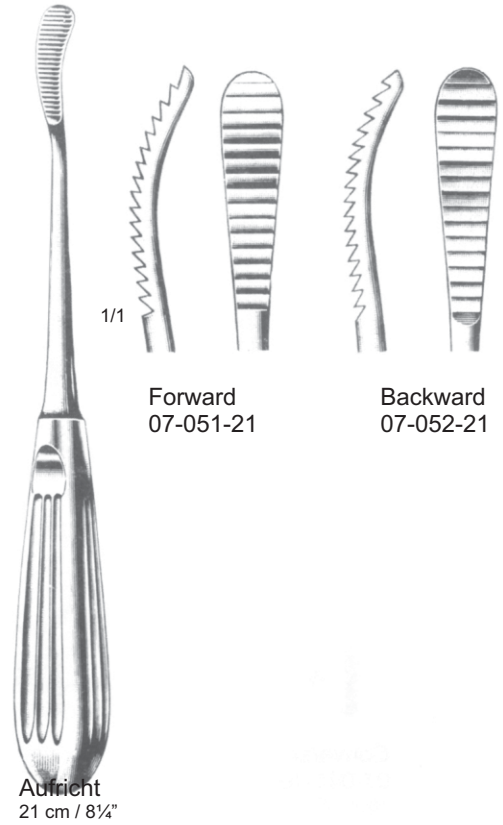
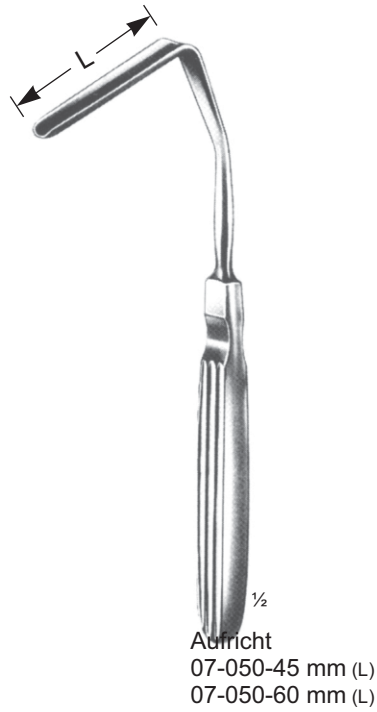

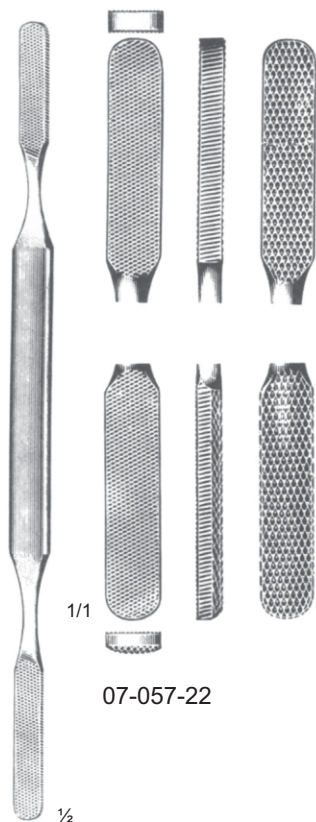

Fomon  
07-057-22  
22 cm / 8 3/4"

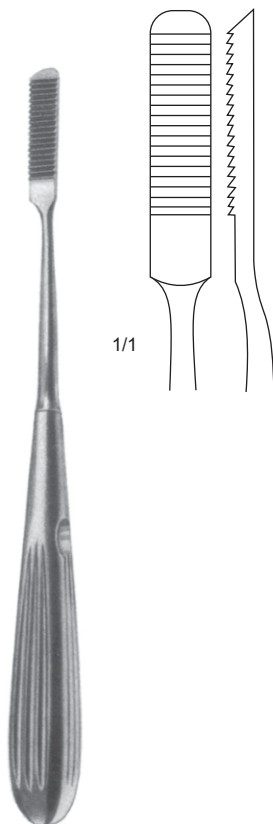

Cottle  
07-058-21  
21 cm / 8 1/4"

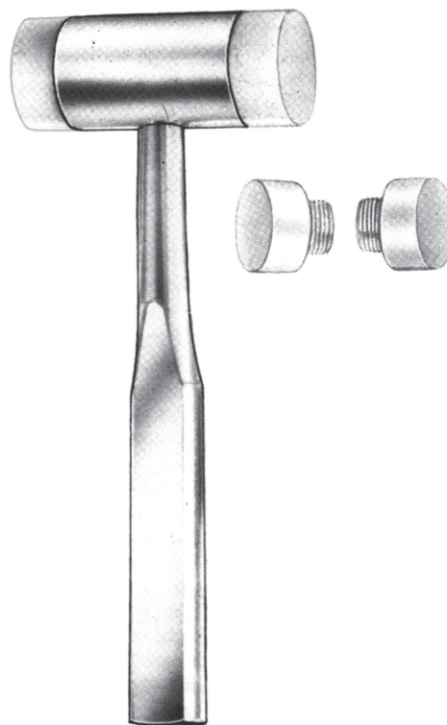

Medro-Mallet  
07-059-19  
19 cm / 7 1/2"



Medro-Mallet  
07-060-19  
19 cm / 7 1/2"

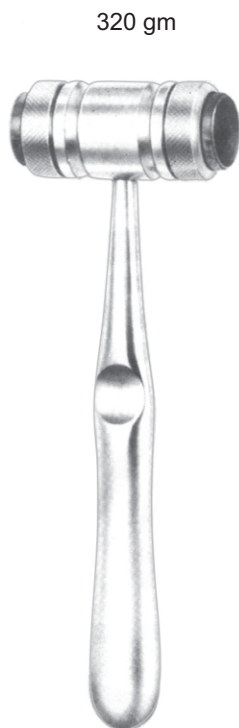

Mead  
07-061-17  
17 cm / 6 3/4"

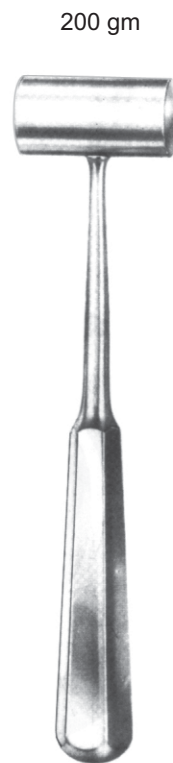

Partch  
07-062-18  
18 cm / 7"





Gigli  
 07-064-30 - 30 cm / 12"  
 07-064-40 - 40 cm / 16"  
 07-064-50 - 50 cm / 20"  
 07-064-60 - 60 cm / 24"  
 07-064-70 - 70 cm / 28"

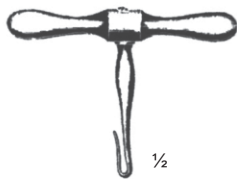

Gigli  
 07-065-06  
 6 cm / 2 1/4"

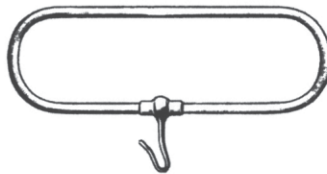

07-066-06



Crutchfield  
 07-067-01 Small  
 07-068-02 Medium  
 07-069-03 Large



[www.krnano.com](http://www.krnano.com)

신경외과

**NEURO SURGERY**

**Page 132 - 142**

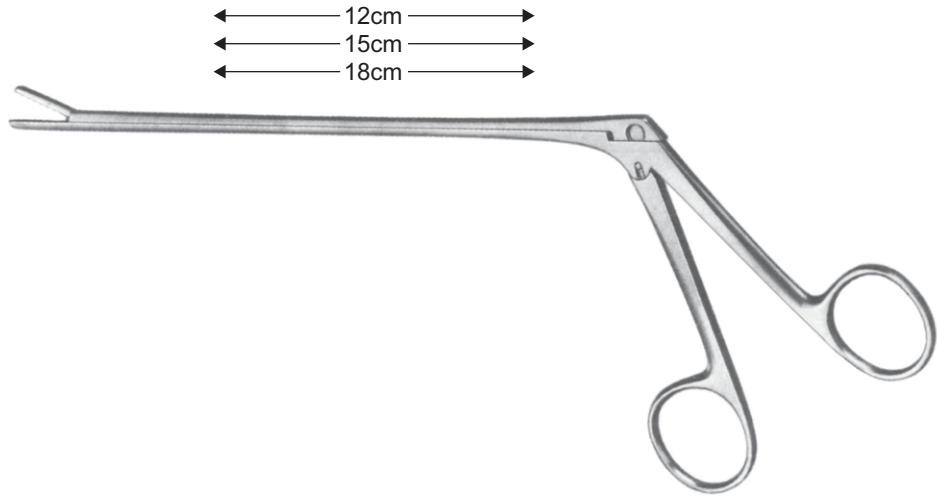

**Cushing**  
2 mm  
1/1

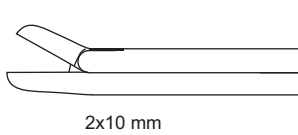

2x10 mm  
08-001-12 12 cm  
08-001-15 15 cm  
08-001-18 18 cm  
Str.

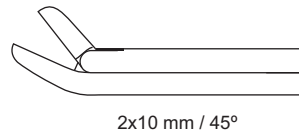

2x10 mm / 45°  
08-002-12 12 cm  
08-002-15 15 cm  
08-002-18 18 cm  
Upward

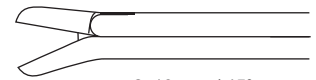

2x10 mm / 45°  
08-003-12 12 cm  
08-003-15 15 cm  
08-003-18 18 cm  
Downward

**Love Gruenwald**  
3 mm  
1/1

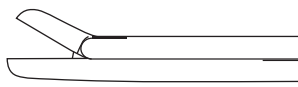

3x10 mm  
08-004-12 12 cm  
08-004-15 15 cm  
08-004-18 18 cm

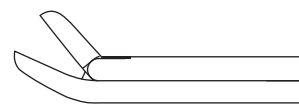

3x10 mm / 45°  
08-005-12 12 cm  
08-005-15 15 cm  
08-005-18 18 cm

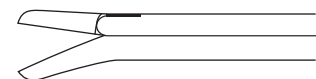

3x10 mm / 45°  
08-006-12 12 cm  
08-006-15 15 cm  
08-006-18 18 cm

**Spurling**  
4 mm  
1/1

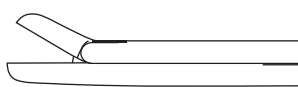

4x10 mm  
08-007-12 12 cm  
08-007-15 15 cm  
08-007-18 18 cm

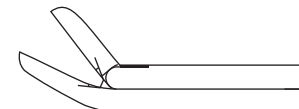

4x10 mm / 45°  
08-008-12 12 cm  
08-008-15 15 cm  
08-008-18 18 cm

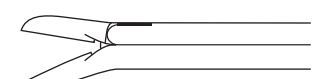

4x10 mm / 45°  
08-009-12 12 cm  
08-009-15 15 cm  
08-009-18 18 cm

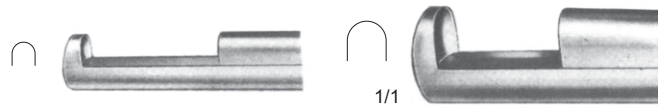

08-010-15 3 mm Bite  
08-010-19 3 mm Bite

08-011-15 5 mm Bite  
08-011-19 5 mm Bite



Colclough 15 cm / 6" Shaft  
08-010-15 3 mm Bite  
08-011-15 5 mm Bite

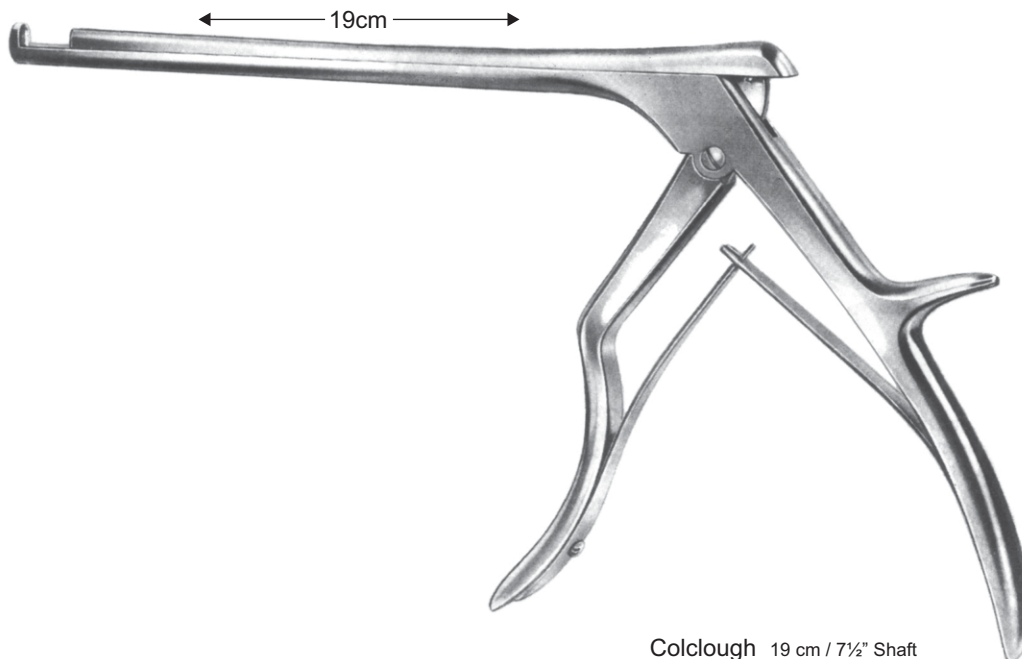

Colclough 19 cm / 7½" Shaft  
08-010-19 3 mm Bite  
08-011-19 5 mm Bite



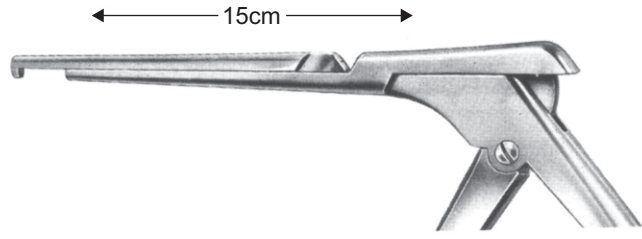
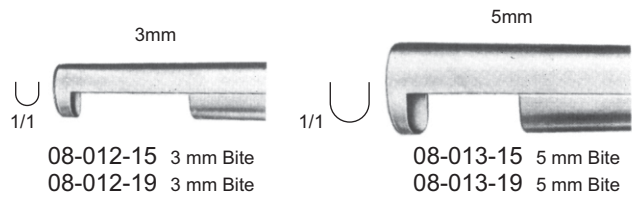

Colclough 15 cm / 6" Shaft  
08-012-15 3 mm Bite  
08-013-15 5 mm Bite

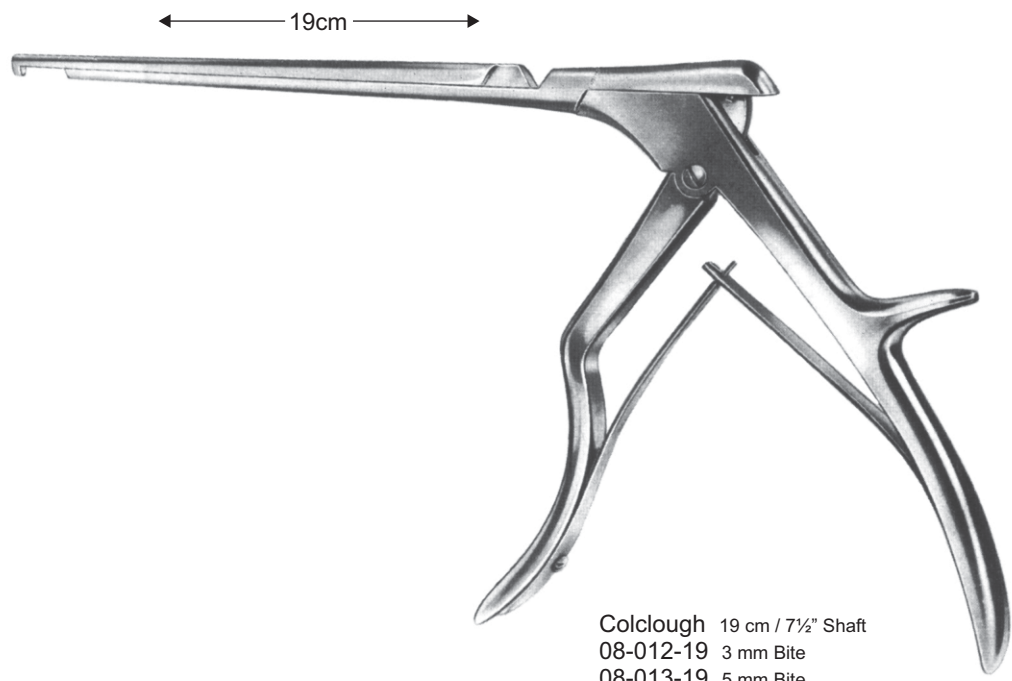

Colclough 19 cm / 7½" Shaft  
08-012-19 3 mm Bite  
08-013-19 5 mm Bite



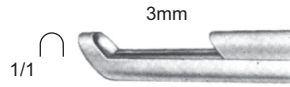

08-014-15 3 mm Bite  
08-014-19 3 mm Bite



08-015-15 5 mm Bite  
08-015-19 5 mm Bite

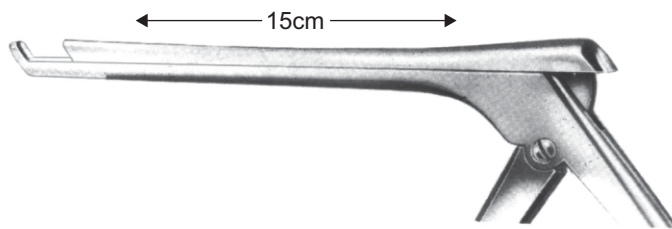

Colclough 15 cm / 6" Shaft  
08-014-15 3 mm Bite  
08-015-15 5 mm Bite

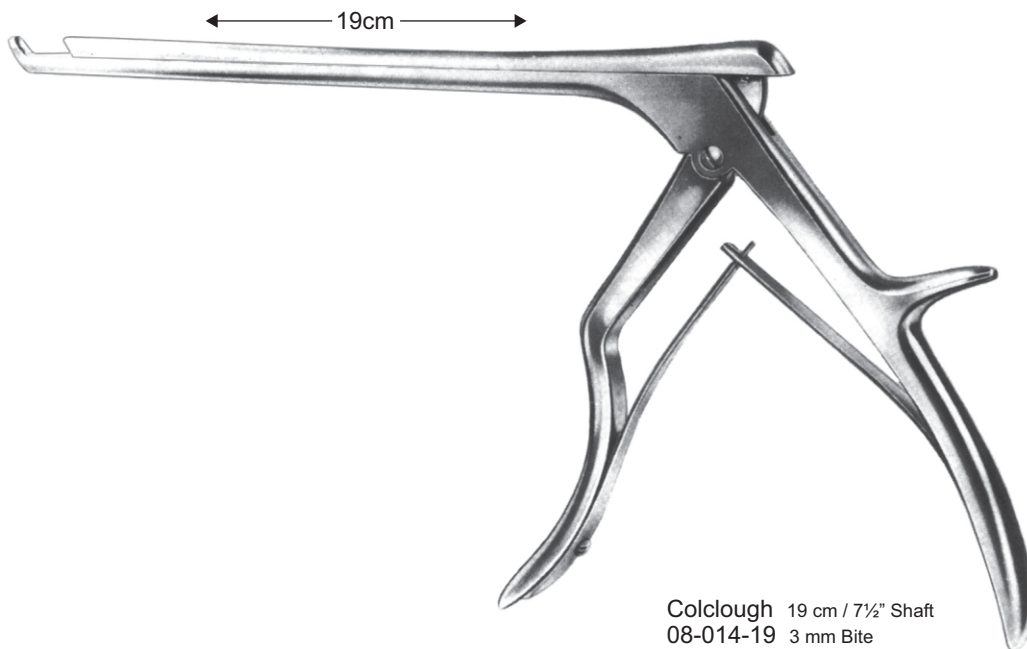

Colclough 19 cm / 7½" Shaft  
08-014-19 3 mm Bite  
08-015-19 5 mm Bite



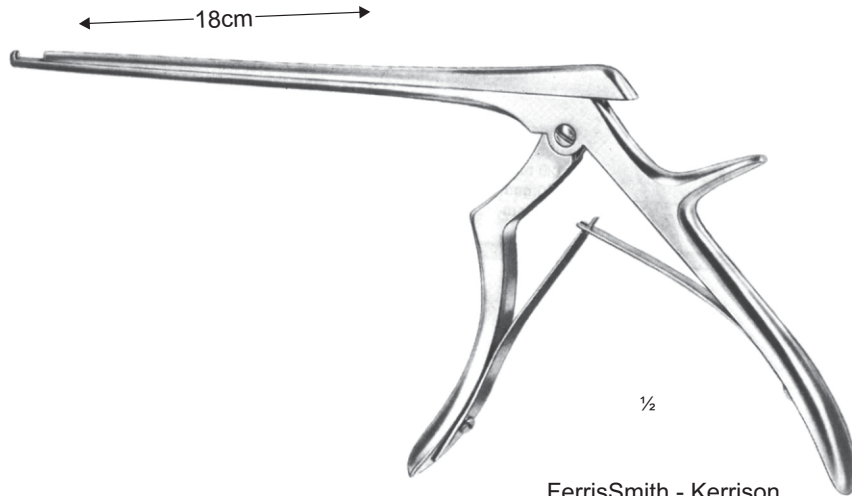

FerrisSmith - Kerrison  
08-016-01 - 08-018-06

- Upward Cutting**
- 1/1 □ 1mm 08-016-01
  - 2mm 08-016-02
  - 3mm 08-016-03
  - 4mm 08-016-04
  - 5mm 08-016-05
  - 6mm 08-016-06

- Downward Cutting**
- 1/1 □ 1mm 08-017-01
  - 2mm 08-017-02
  - 3mm 08-017-03
  - 4mm 08-017-04
  - 5mm 08-017-05
  - 6mm 08-017-06

- Forward Cutting**
- 1/1 □ 1mm 08-018-01
  - 2mm 08-018-02
  - 3mm 08-018-03
  - 4mm 08-018-04
  - 5mm 08-018-05
  - 6mm 08-018-06

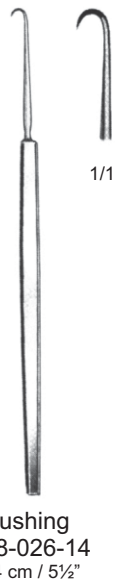
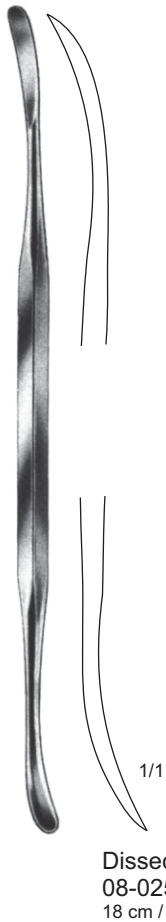
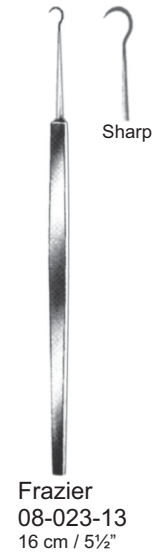
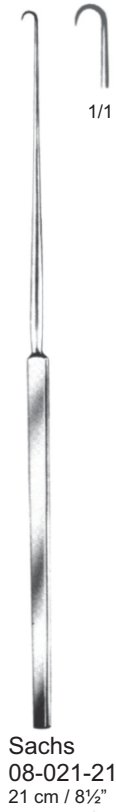
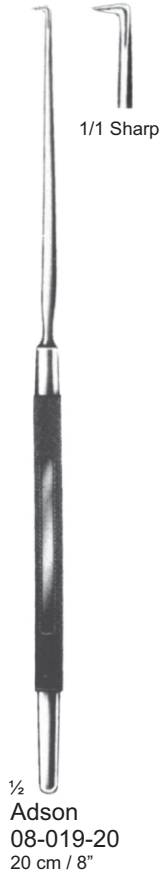

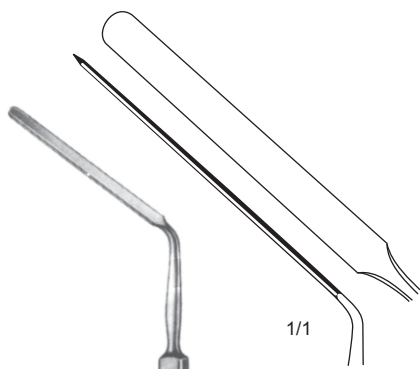

Horsley  
08-030-20  
20 cm / 8"



Sachs  
08-031-21  
21 cm / 8 1/4"

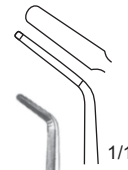

Hoehn  
08-032-15  
15 cm / 6"



Hoehn  
08-033-15  
15 cm / 6"



Sachs  
08-034-21  
21 cm / 8 1/4"

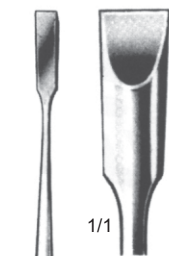

Adson  
08-035-01 - 08-035-04  
17 cm / 6 3/4"



08-035-02



08-035-03



08-035-04

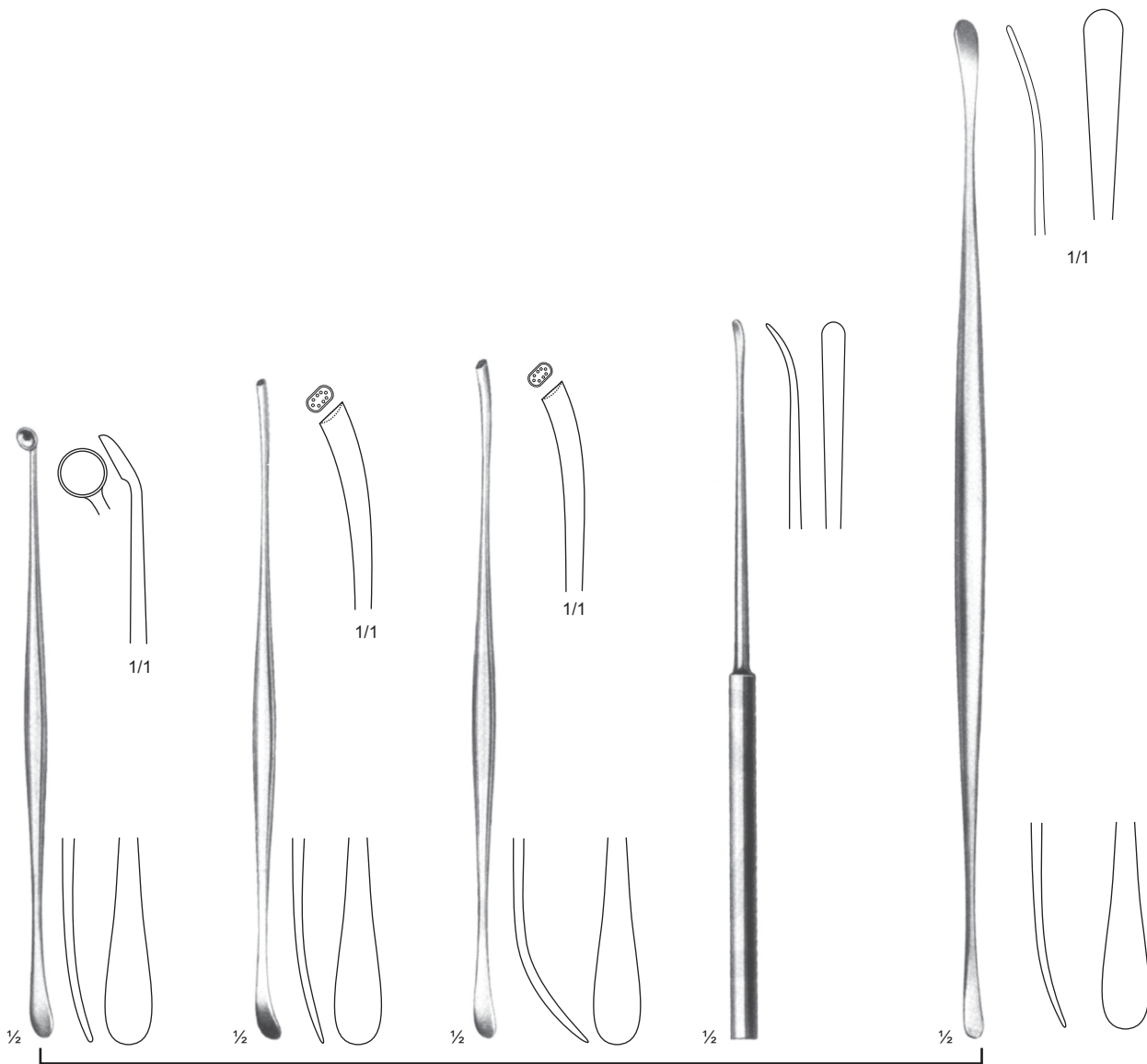

08-036-01  
18 cm / 7"

08-036-02  
19 cm / 7 3/4"

Penfield  
08-036-03  
19 cm / 7 3/4"

08-036-04  
20 cm / 8"

08-036-05  
28 cm / 11 1/2"





1/1

Love Retractor  
08-037-00  
20 cm / 8"



1/1  
45°

Love Retractor  
08-037-45  
20 cm / 8"



1/1  
90°

Love Retractor  
08-037-90  
20 cm / 8"



1/1

Freer  
08-038-18  
18 cm / 7"



Cushing  
08-039-01 - 08-039-03  
19 cm / 7½"

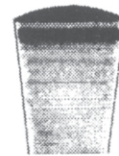

08-039-01  
Str

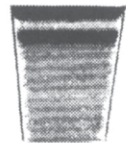

08-039-02  
Square



08-039-03  
Cvd.



Scoville  
08-040-23  
23 cm / 9"

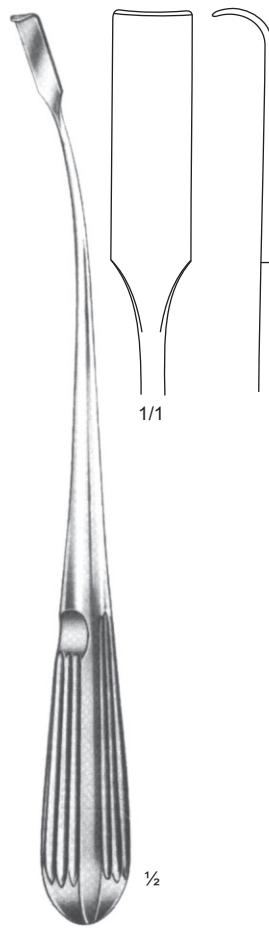

Holscher  
08-041-24  
24 cm / 9½"

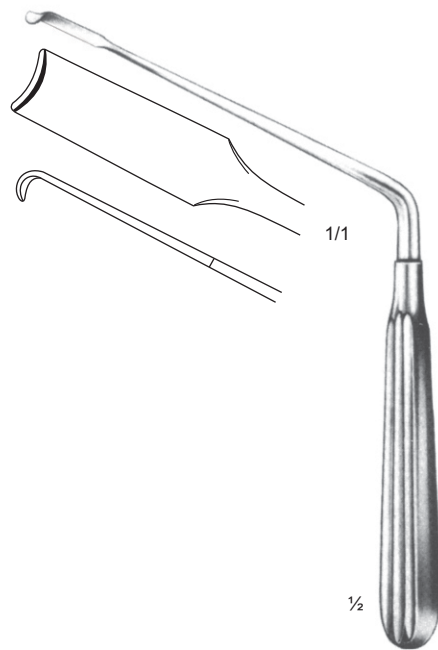

Scoville  
08-042-20  
20 cm / 8"





**Graefe**  
08-043-01 - 08-043-02  
16 cm / 6 1/4"



1/1  
08-043-01  
Sharp



1/1  
08-043-02  
Blunt



**Graefe**  
08-044-01 - 08-044-04  
16 cm / 6 1/4"



1/1  
08-044-01



1/1  
08-044-02



1/1  
08-044-03



1/1  
08-044-04



**O'Connor**  
08-045-16  
16 cm / 6 1/4"



1/1  
08-045-16



**Guthrie**  
08-046-01 - 08-046-02  
16 cm / 6 1/4"



1/1  
08-046-01



08-046-02



**Flexible**  
08-047-02 - 08-048-04  
16 cm / 6 1/4"



1/1  
08-047-02



08-048-02



1/1  
08-047-03



08-048-03



1/1  
08-047-04  
Sharp



08-048-04  
Blunt



**Desmarres**  
08-049-01 - 08-049-06  
16 cm / 6 1/4"



08-049-01



08-049-03



08-049-05



08-049-02



08-049-04



08-049-06





[www.krnano.com](http://www.krnano.com)

리트렉터/개창기구

**RETRACTORS**

**Page 144 - 166**

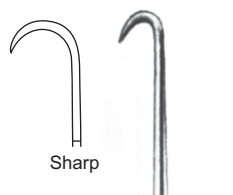

09-001-01



09-001-02

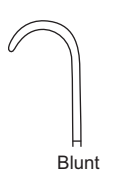

09-002-01



09-002-02



09-001-03



09-001-04



09-002-03



09-002-04

09-001-01 - 09-001-04  
16.5 cm / 6½"

09-002-01 - 09-002-04  
16.5 cm / 6½"



09-003-01

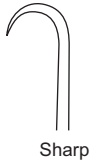

Sharp



09-003-02



09-003-03



09-003-04



09-004-01

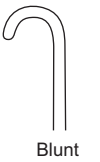

Blunt



09-004-02



09-004-03



09-004-04

09-003-01 - 09-003-04  
16.5 cm / 6½"

09-003-01 - 09-003-04  
16.5 cm / 6½"

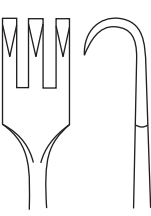

Sharp



09-005-01

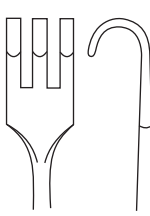

Blunt



09-005-02

Senn-muller  
09-005-01 - 09-005-02  
16.5 cm / 6½"

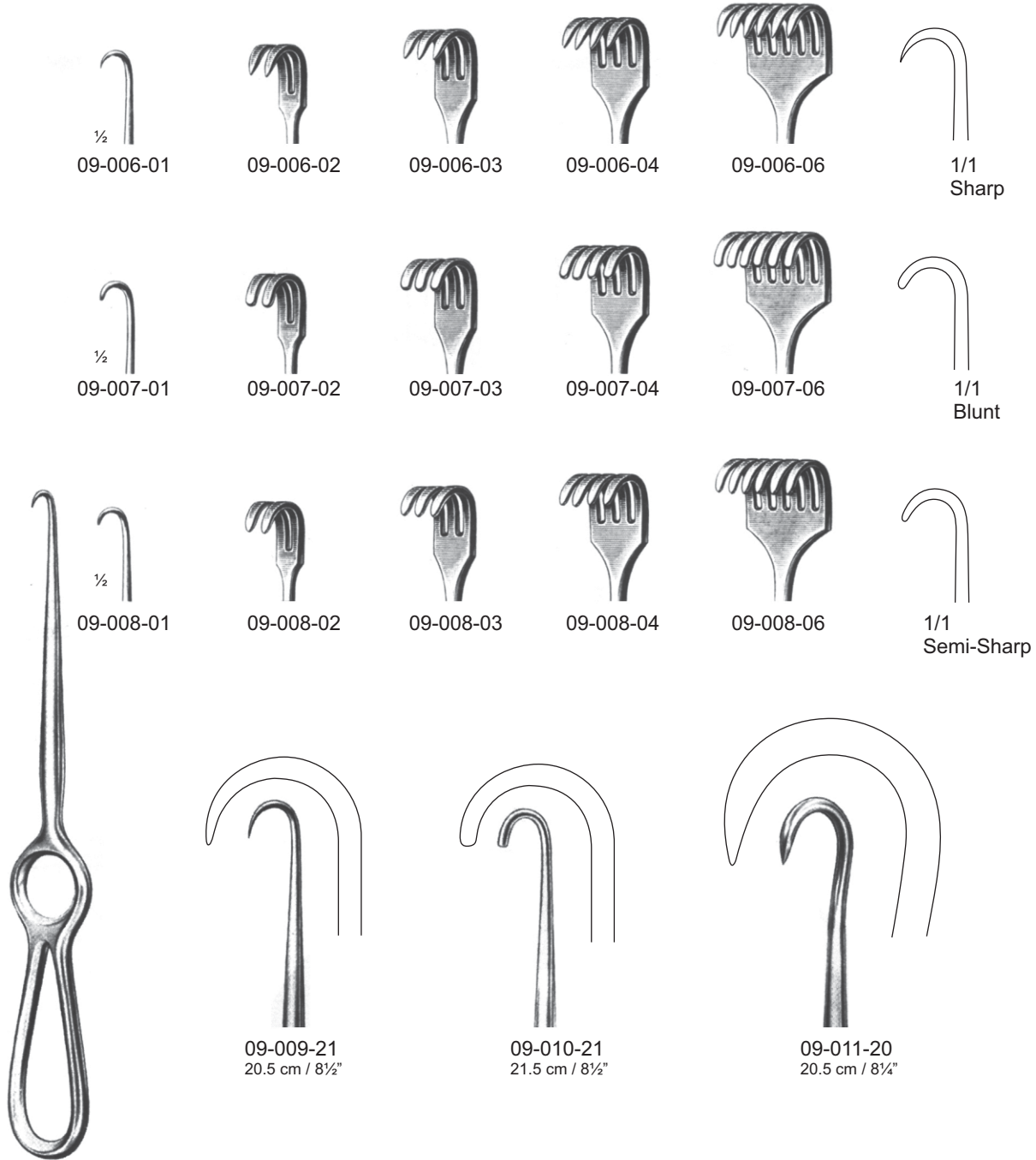

Volkman  
09-006-01 - 09-011-20  
22 cm / 8 3/4"



Volkman  
09-012-01 - 09-013-06  
25 cm / 8½"

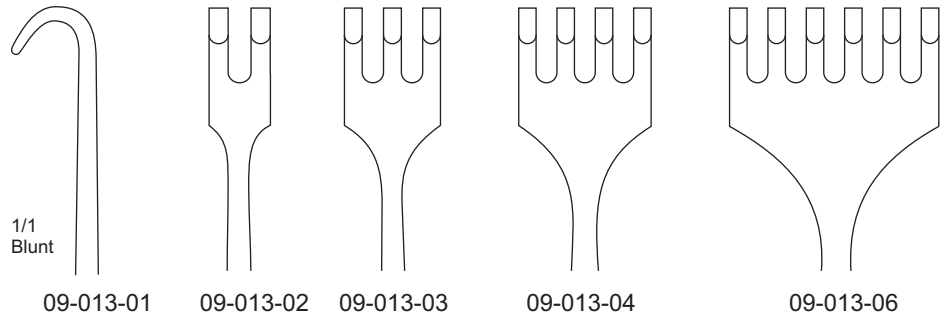
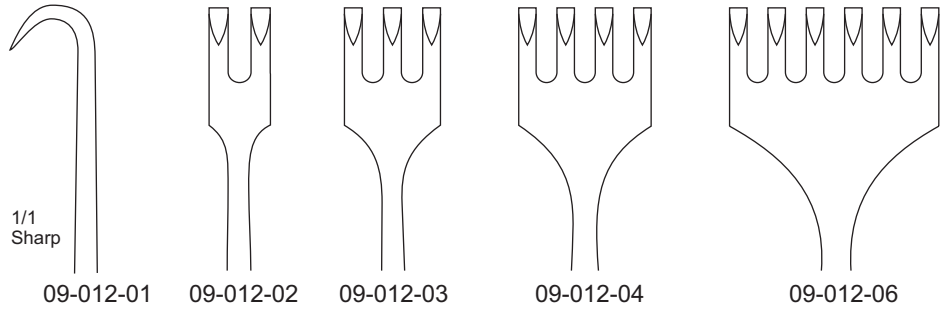

Langenbeck  
09-014-01 - 09-014-05  
22 cm / 8½"



Langenbeck  
09-015-01 - 09-015-05  
22 cm / 8½"

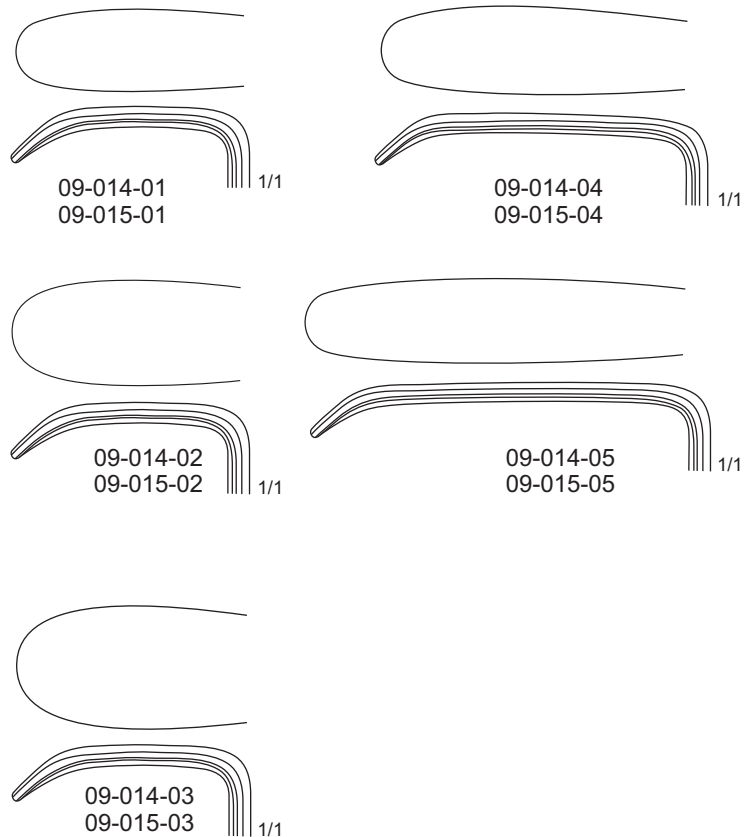

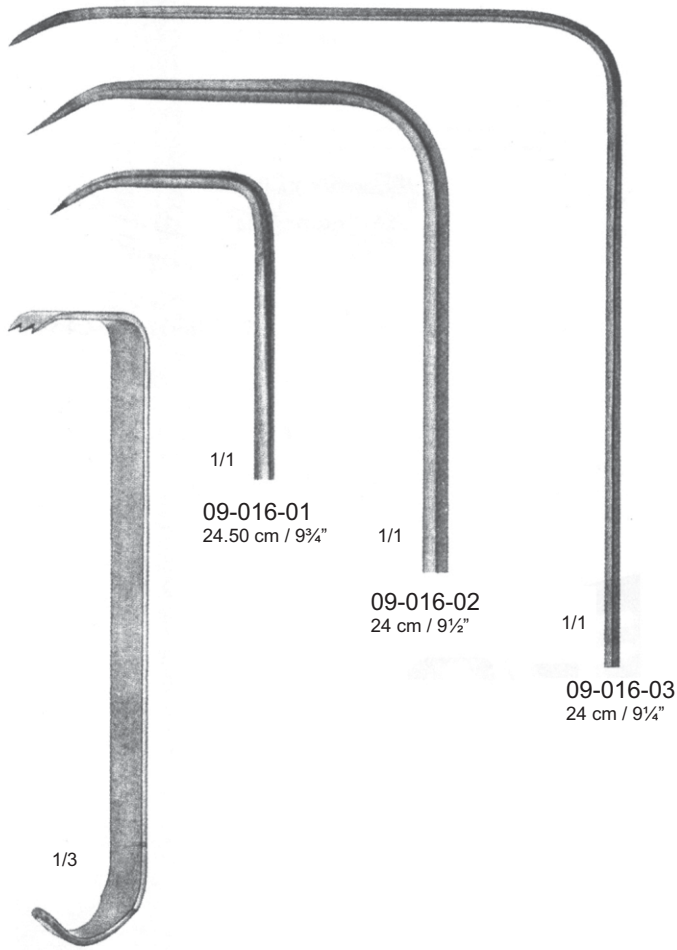

Hibbs  
09-016-01 - 09-016-03

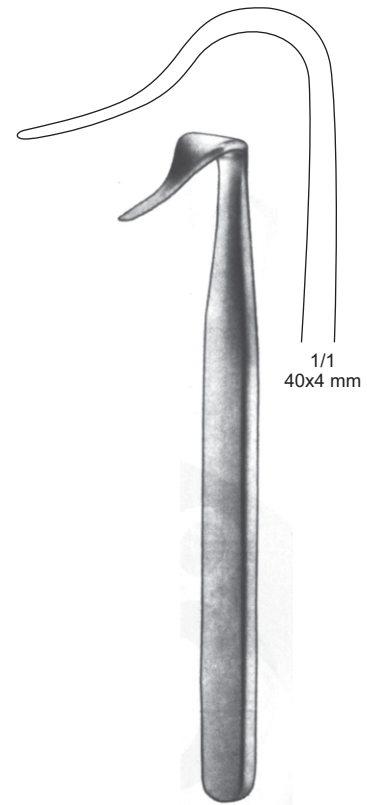

Blount  
09-017-18  
18 cm / 7"



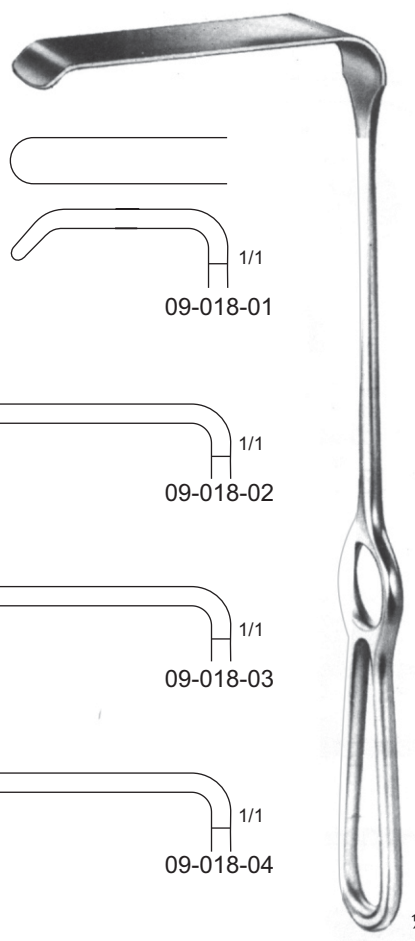
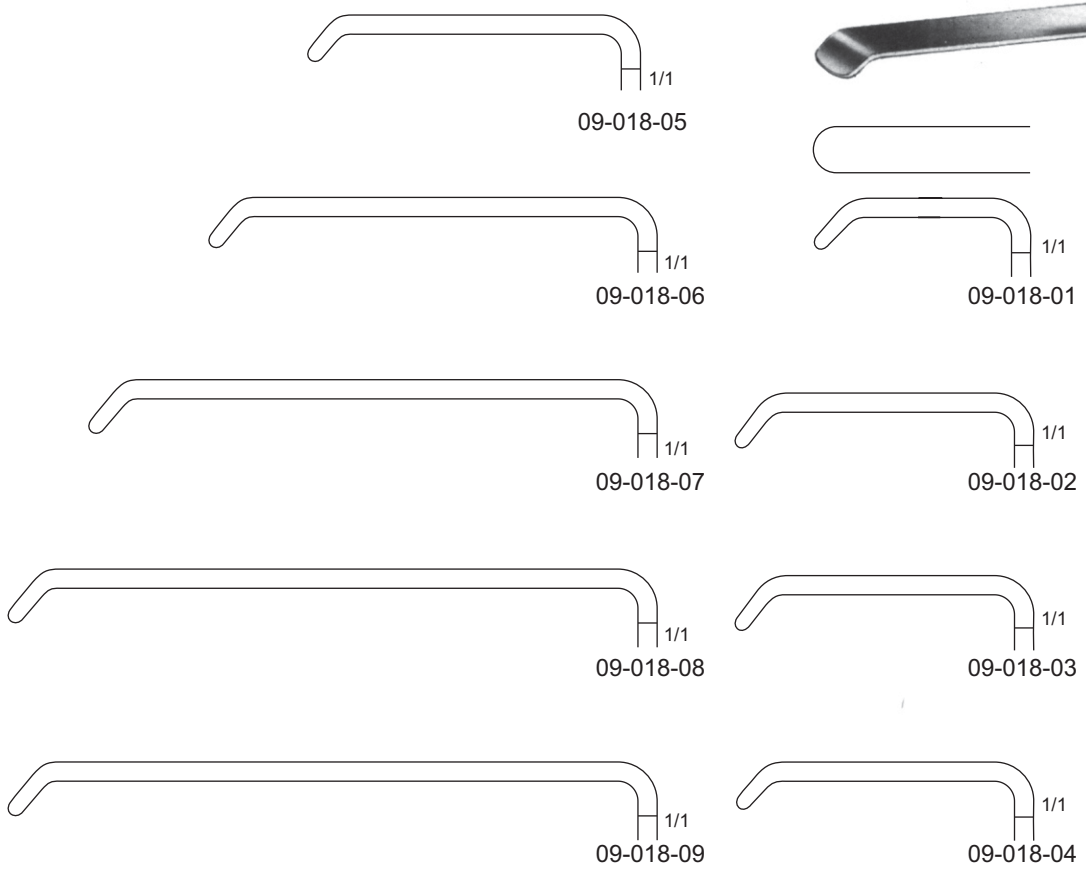

Koacher  
09-018-01 - 09-018-09



Middledorf  
09-019-01 - 09-019-03

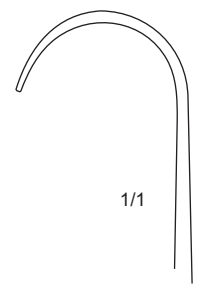

1/1  
09-019-01  
21.5 cm / 8½"

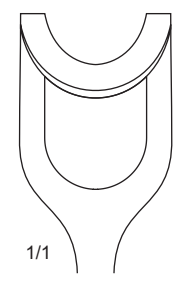

1/1  
09-019-02  
22 cm / 8¾"

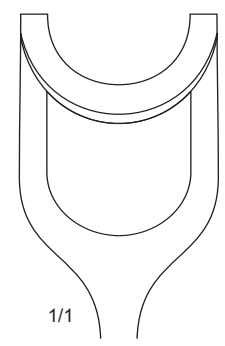

1/1  
09-019-03  
23.5 cm / 9½"

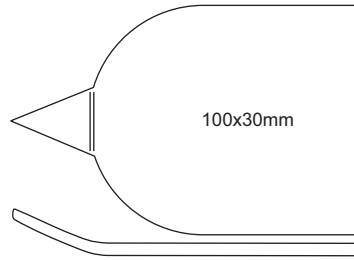

100x30mm

09-021-16

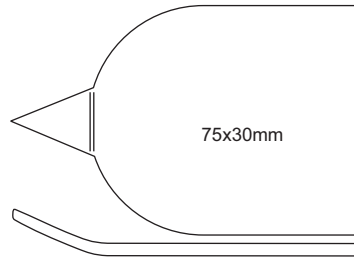

75x30mm

09-020-16

**Taylor**  
09-020-16 - 09-021-16  
16 cm / 6 1/2"

L - 49x38mm  
S - 28x20mm

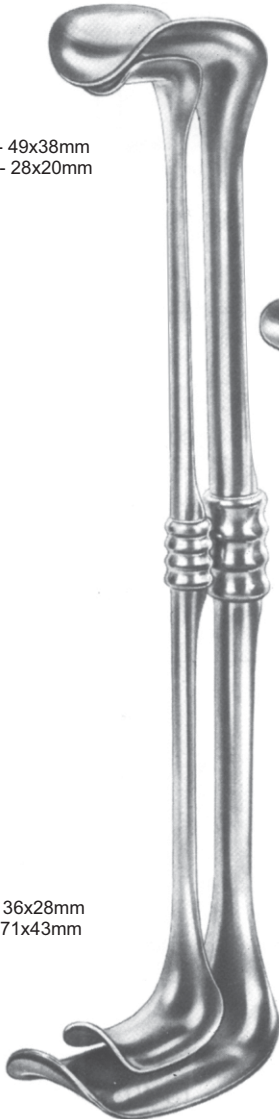

S - 36x28mm  
L - 71x43mm

**Richardson Eastman**  
09-022-00 Set of 2  
09-022-01 Small  
09-022-02 Large



**Richardson**  
09-023-01 - 09-023-03  
24 cm / 9 1/2"

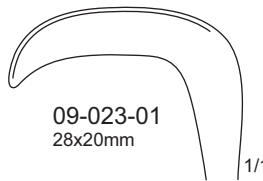

09-023-01  
28x20mm

1/1

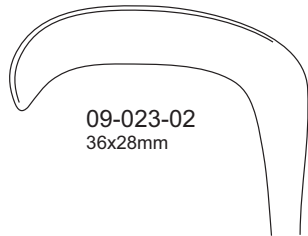

09-023-02  
36x28mm

1/1

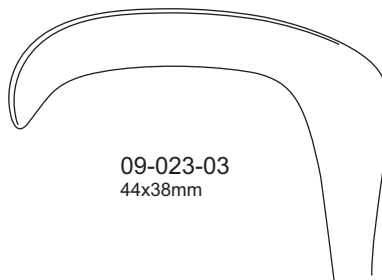

09-023-03  
44x38mm

1/1

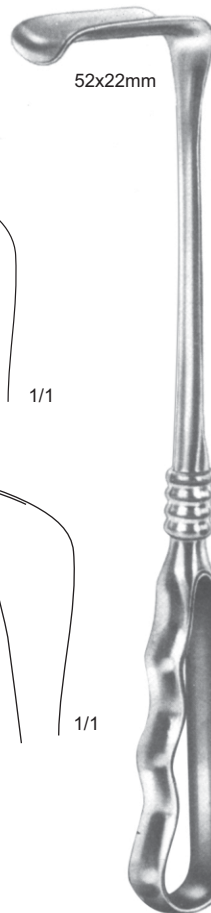

52x22mm

1/2

**Richardson**  
09-024-24  
24 cm / 9 1/2"



70x50mm

1/2

**Kelly**  
09-025-26  
26 cm / 10 1/2"





Israel  
09-026-01 - 09-026-04  
23.5 cm / 9 1/4"

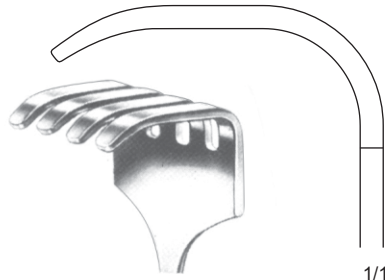

09-026-01  
40x40mm

1/1

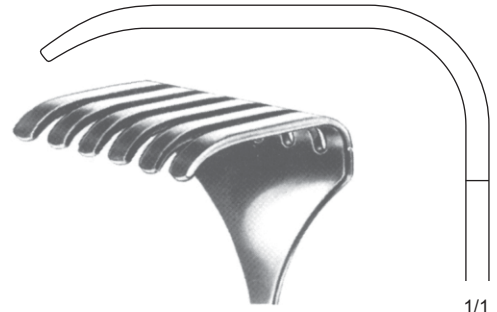

09-026-03  
50x60mm

1/1

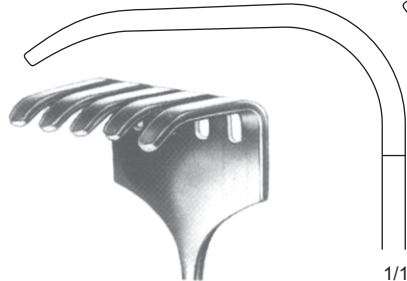

09-026-02  
45x50mm

1/1

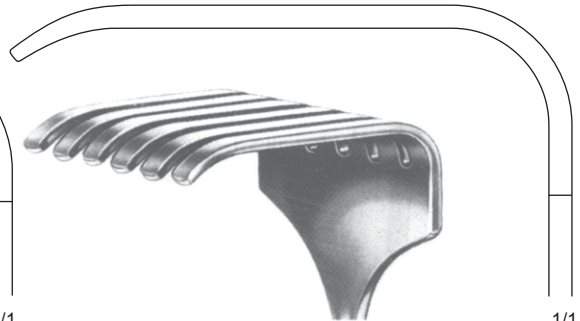

09-026-04  
70x70mm

1/1



50x85mm

Doyen  
09-027-25  
25 cm / 10"

1/2



Kocher  
09-028-01 70x25mm  
09-028-02 80x45mm  
09-028-03 80x55mm  
09-028-04 80x65mm  
23.5 cm / 9 1/4"





Deaver  
09-029-18  
18 cm / 7"

Deaver  
09-029-21  
21.5 cm / 8½"

Deaver  
09-029-23  
23 cm / 9"

Deaver  
09-029-30  
30 cm / 12"

Deaver  
09-029-33  
33 cm / 13"

Deaver  
09-029-36  
36 cm / 14"





Farabeuf  
09-030-00  
12 cm / 4 3/4"

1/1

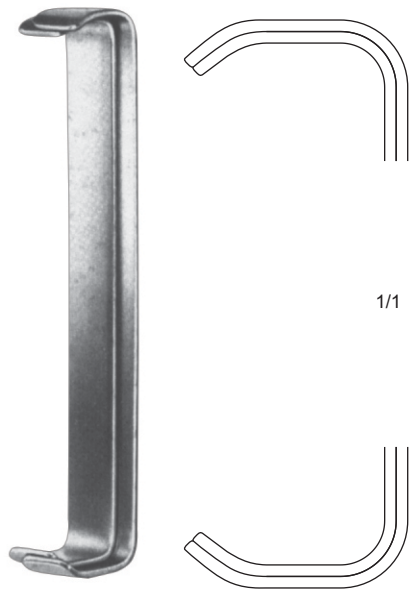

Farabeuf  
09-031-00  
15 cm / 6"

1/1

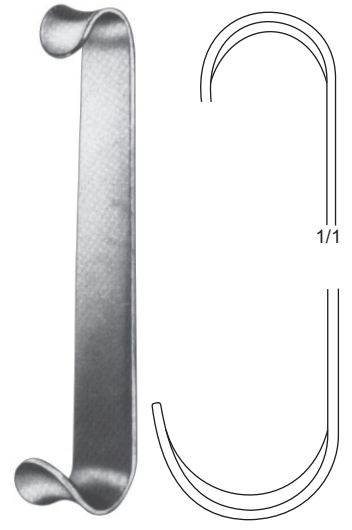

Baby-Roux  
09-032-00  
13 cm / 5 1/4"

1/1



Deaver  
09-033-30  
30 cm / 12"

1/2



Roux  
09-034-00 Set Of 3  
09-034-01 15 cm  
09-034-02 16 cm  
09-034-03 17 cm

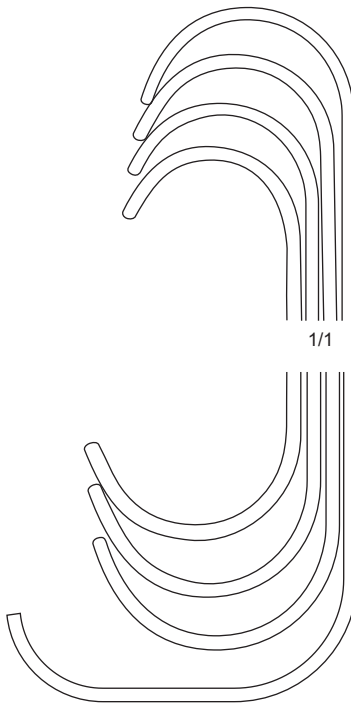

1/1

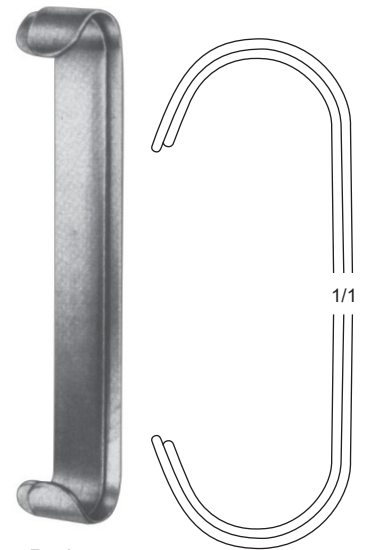

Parker  
09-035-00  
13.5 cm / 5 1/2"

1/1



**Us-Army Retractor**  
09-036-00  
21 cm / 8¼"

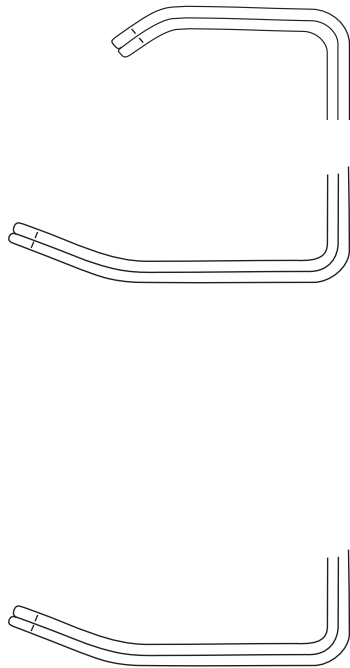

**Jansen**  
09-037-10  
10 cm / 4"

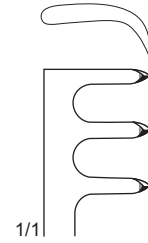

**Finsen**  
09-038-05 - 09-041-07  
5 cm / 2"  
7 cm / 2½"

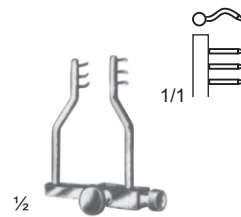
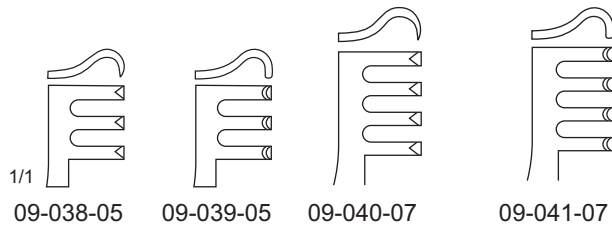

**Logan**  
09-042-04  
4 cm / 2"





**Gelpi**  
09-043-17  
13.5 cm / 5 1/4"



**Gelpi**  
09-044-17  
17.5 cm / 7"

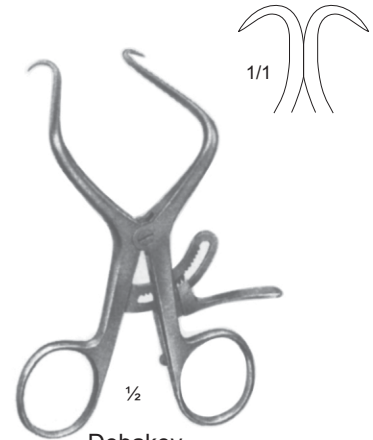

**Debaquey**  
09-045-10  
10 cm / 4"



**Anderson-Adson**  
09-046-19  
19.5 cm / 8"



**Weitlaner**  
09-047-01 - 09-047-02  
20 cm / 8"

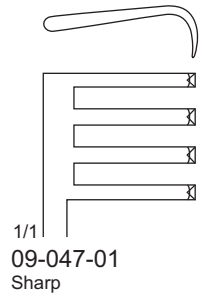

1/1  
09-047-01  
Sharp

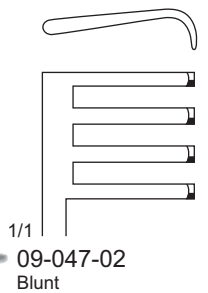

1/1  
09-047-02  
Blunt



**Weitlaner-Locktite**  
 09-048-01 - 09-048-02  
 10 cm / 4 1/4"

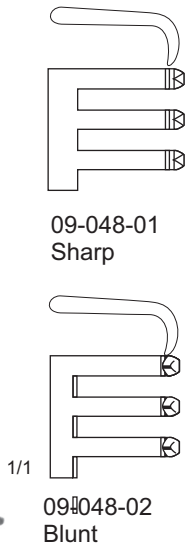

09-048-01  
 Sharp

09-048-02  
 Blunt



**Weitlaner**  
 09-049-13 - 09-050-16



09-049-13  
 13 cm / 5"  
 Sharp

09-050-13  
 13 cm / 5"  
 Blunt



09-049-16  
 16.5 cm / 6 1/2"  
 Sharp

09-050-16  
 16.5 cm / 6 1/2"  
 Blunt



**Weitlaner-Wullstein**  
 09-051-01 - 09-051-02  
 13 cm / 5"

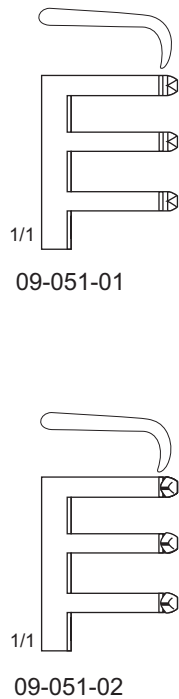

09-051-01

09-051-02



**Mollison**  
 09-052-15  
 15 cm / 6"

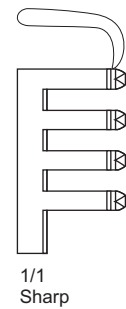

1/1  
 Sharp





Beckmann  
09-053-31  
31 cm / 12½"

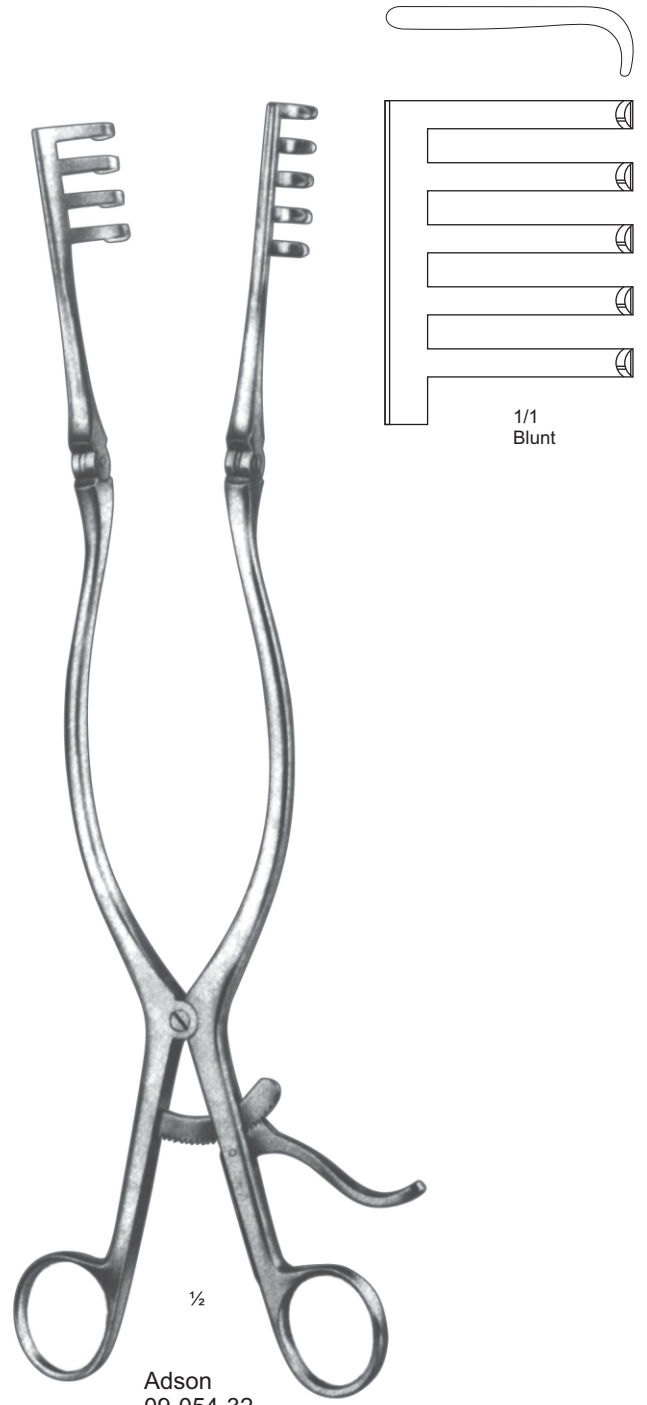

Adson  
09-054-32  
32 cm / 12½"



Beckmann-Adson  
09-055-01 - 09-055-04  
31 cm / 12¼"

1/1

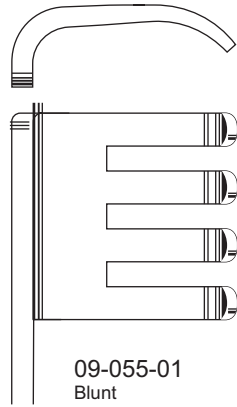

09-055-01  
Blunt

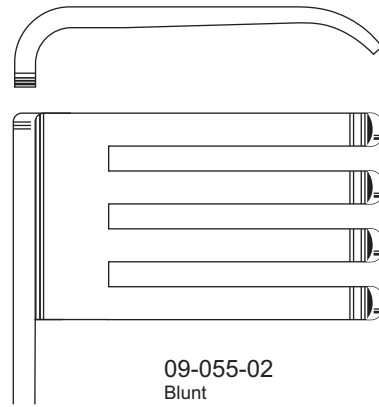

09-055-02  
Blunt

1/1

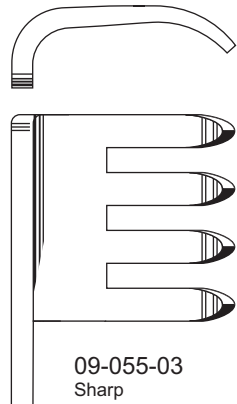

09-055-03  
Sharp

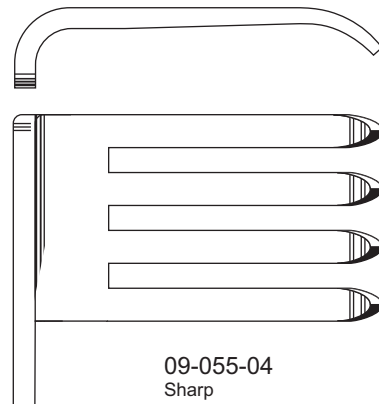

09-055-04  
Sharp





1/2  
Baby Collin  
09-056-00

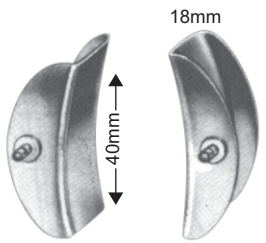

Spare Blade

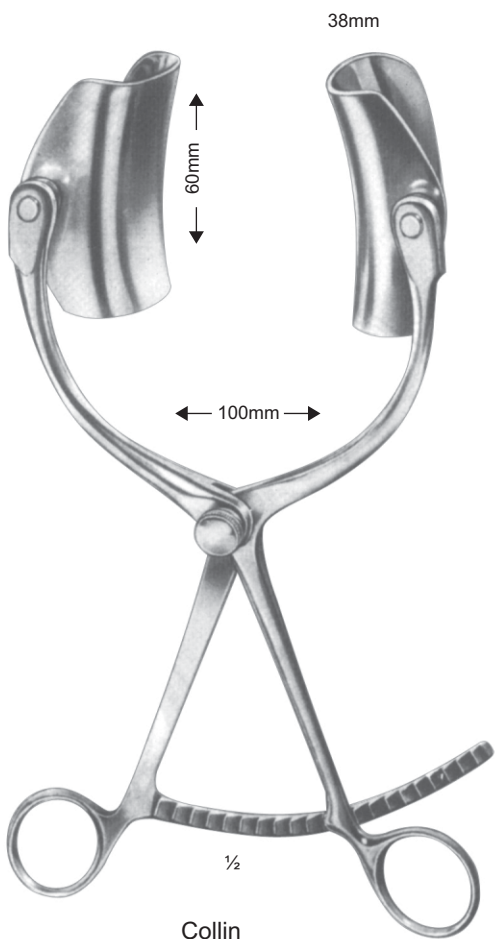

1/2  
Collin  
09-057-00

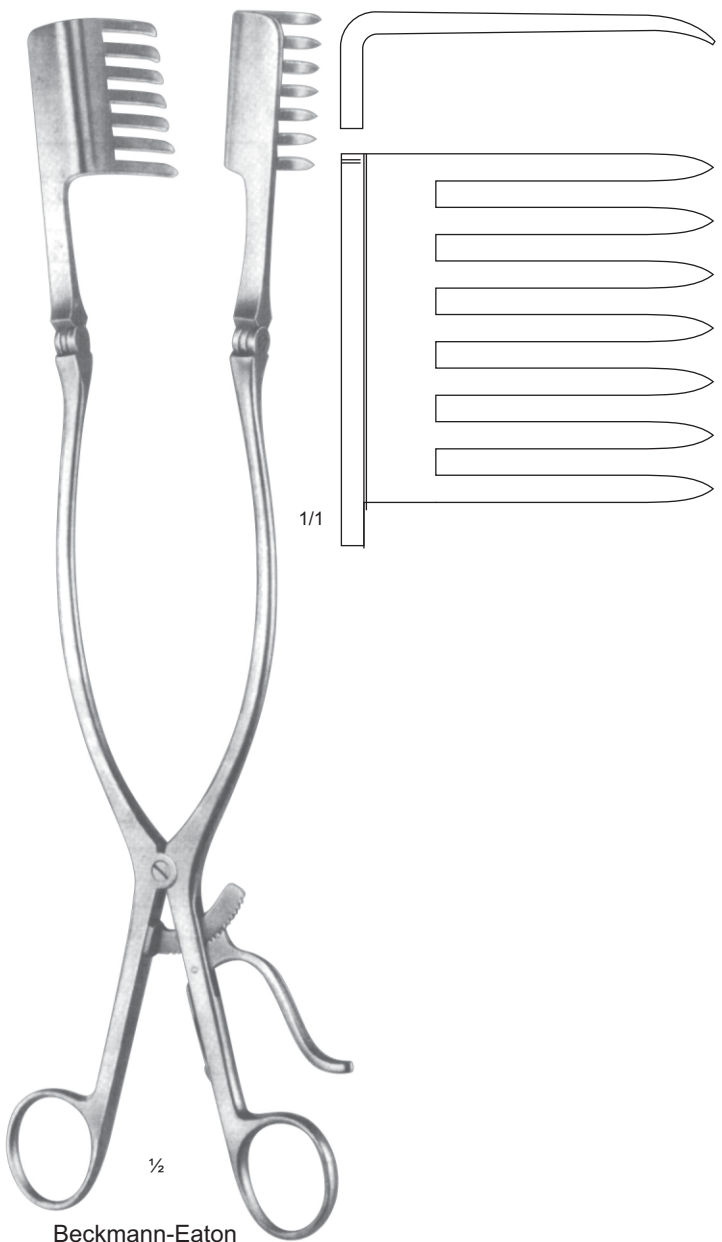

1/2  
Beckmann-Eaton  
09-058-32  
32 cm / 12 1/2"





Collin	Lateral	Central
09-059-00	30x60mm	38x55
09-060-00	38x80mm	50x75

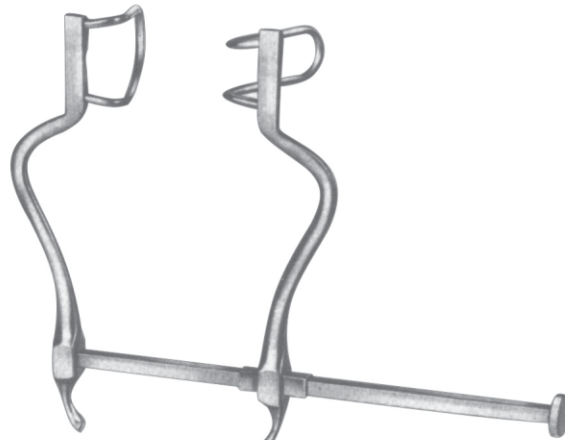

Gosset  
09-061-00

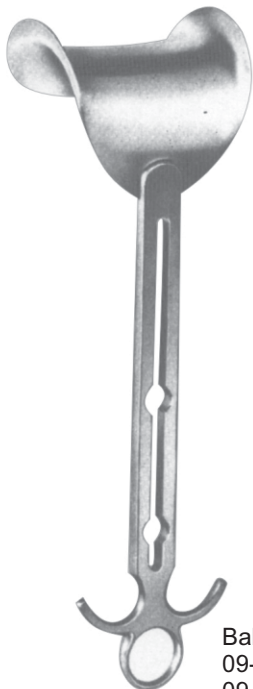

Balfour (Central Blade Only)  
09-062-01 45x80mm  
09-062-02 70x85mm

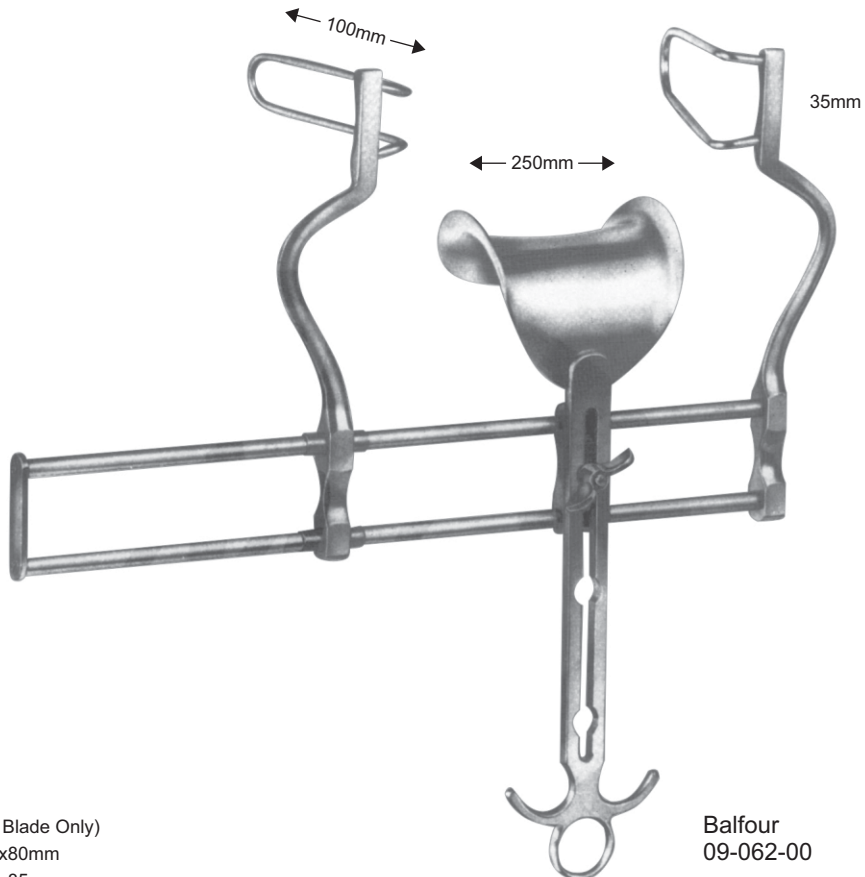

Balfour  
09-062-00



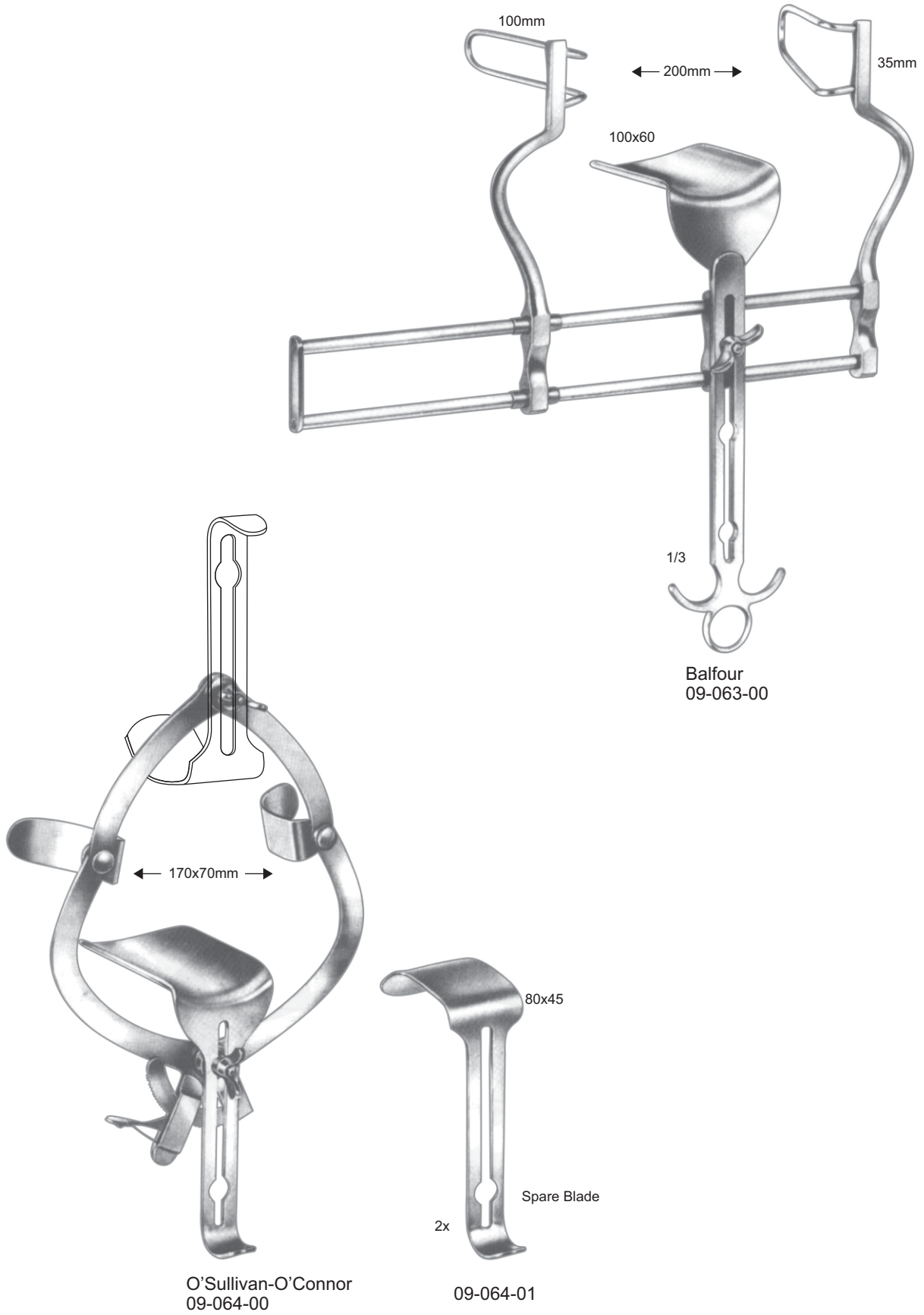

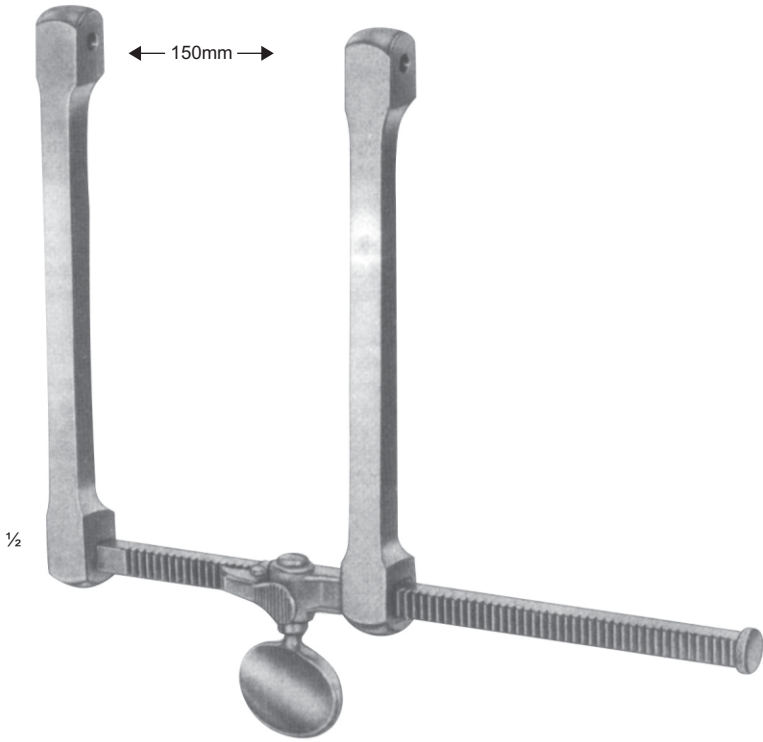

Scoville Frame only  
09-065-00



Scoville  
09-065-01  
50mm / 2"

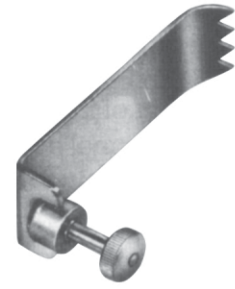

Scoville  
09-065-05 60x25mm  
09-065-06 64x50mm  
09-065-07 88x25mm



Scoville  
09-065-02  
70mm / 2 3/4"

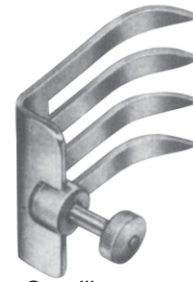

Scoville  
09-065-08 41x38mm  
09-065-09 67x44mm

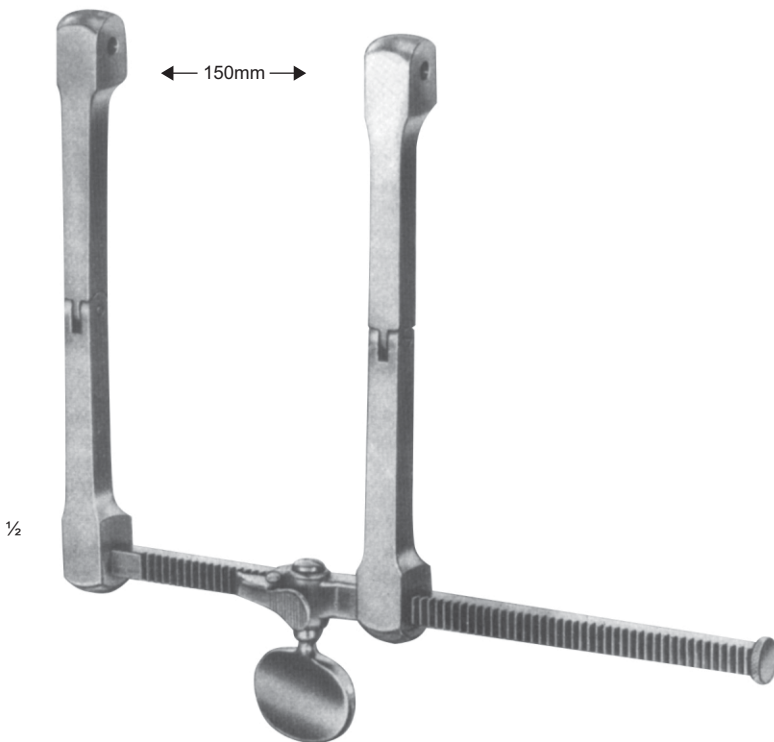

Scoville-Haverfield  
09-066-00



Scoville  
09-065-03  
50mm / 2"



Scoville  
09-065-04  
70mm / 2 3/4"

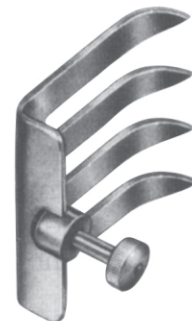

Taylor  
09-065-10 48x50mm  
09-065-11 64x65mm  
09-065-12 64x64mm  
09-065-13 80x57mm



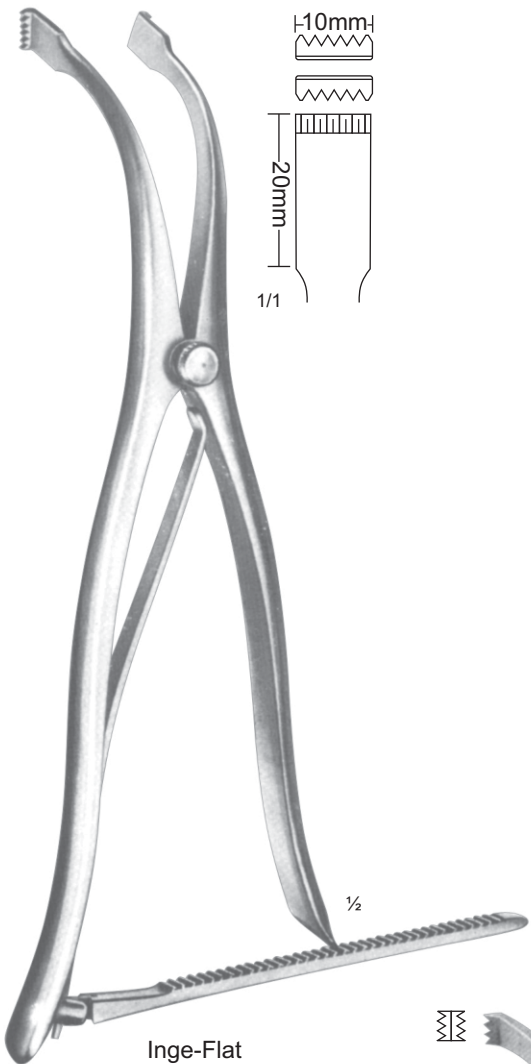

**Inge-Flat**  
09-067-24  
24 cm / 9 3/4"

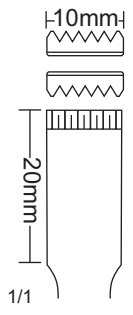

**Inge-Concave**  
09-068-24  
24 cm / 9 3/4"



**Inge-Child**  
09-069-16  
16 cm / 6 1/4"

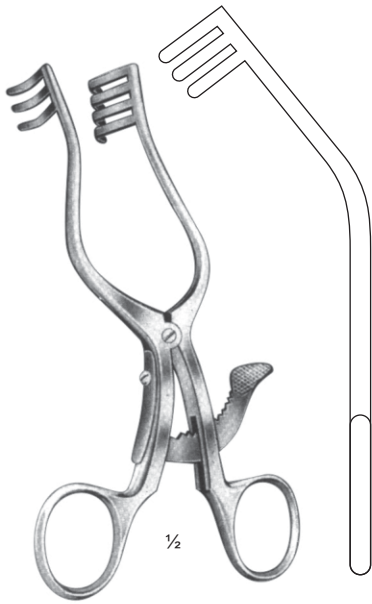

**Contour**  
09-070-14  
14 cm / 5 1/2"



**Meyerding**  
09-071-32 32x25mm  
09-071-54 54x25mm  
09-071-60 60x25mm  
09-071-61 60x19mm  
20 cm / 8"



**Markham-Meyerding**  
09-072-18  
18 cm / 7"

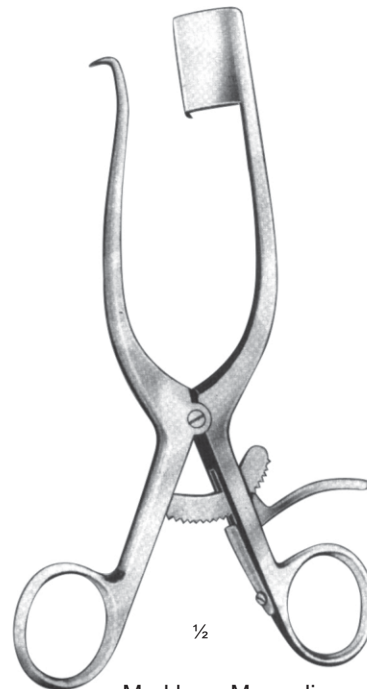

**Markham-Meyerding**  
09-073-18  
18 cm / 7"



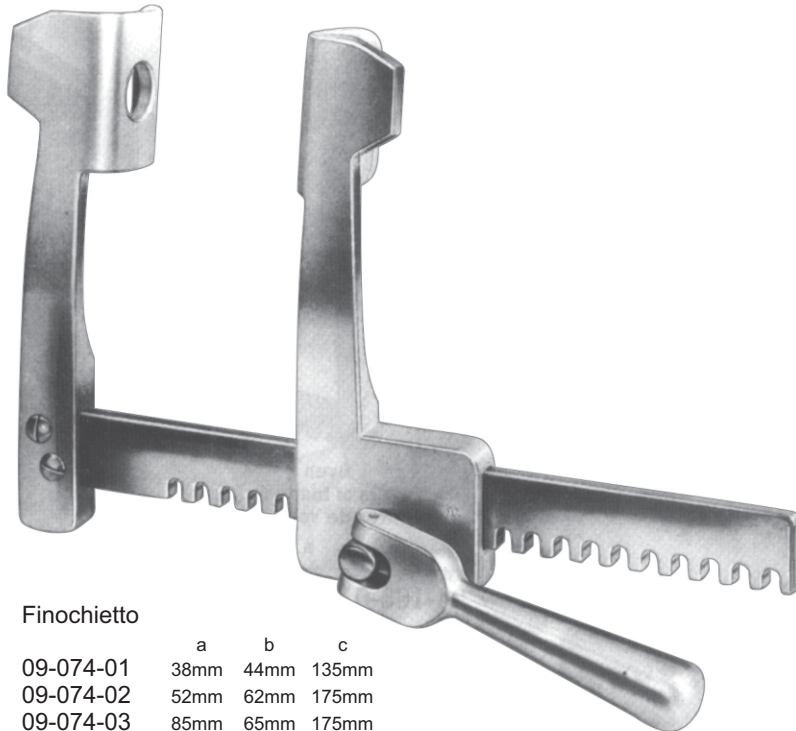

Finochietto

	a	b	c
09-074-01	38mm	44mm	135mm
09-074-02	52mm	62mm	175mm
09-074-03	85mm	65mm	175mm

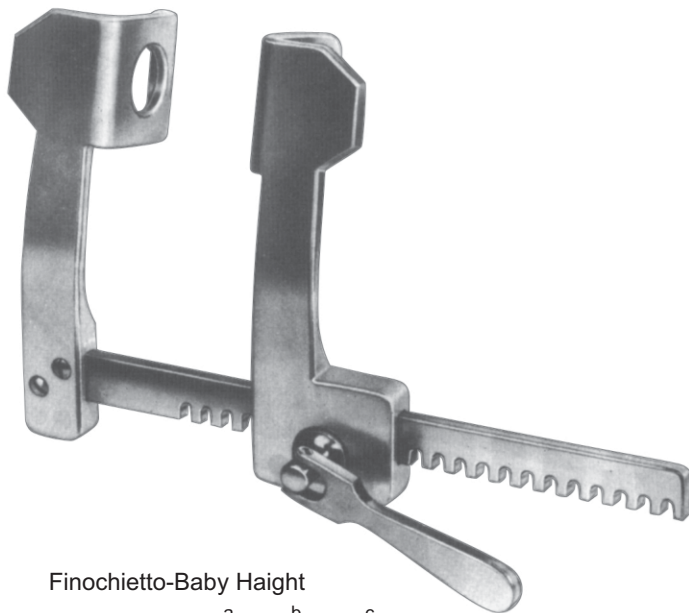
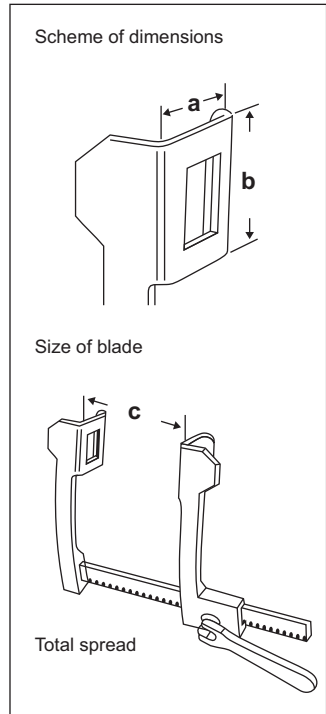

Finochietto-Baby Haight

	a	b	c
09-075-00	31mm	31mm	100mm

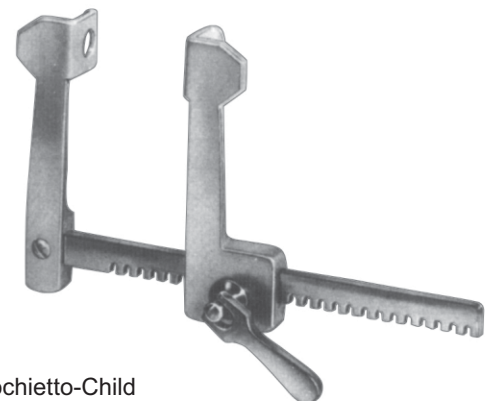

Finochietto-Child

	a	b	c
09-076-00	15mm	18mm	75mm

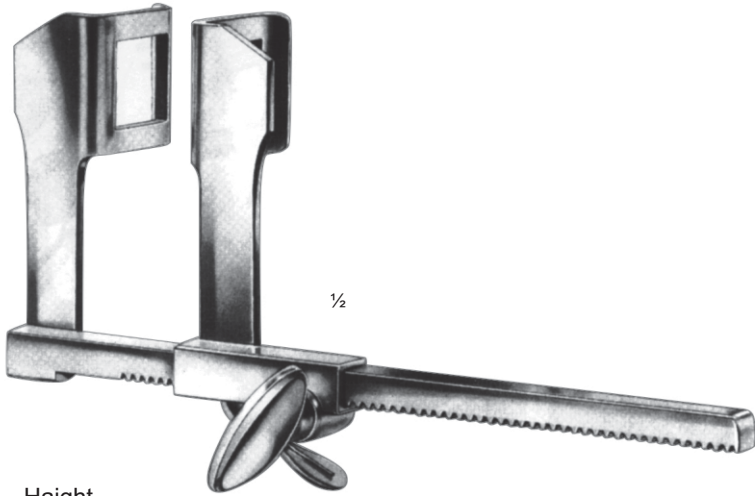

Haight

09-077-00      a      b      c  
30mm    30mm    90mm

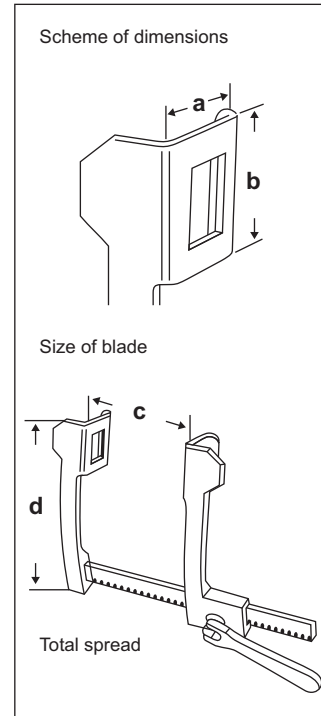

Tuffier

09-078-00      a      b      c  
50mm    45mm    165mm





½

**Baily-Bally**  
09-079-14  
14.5 cm / 5¾"

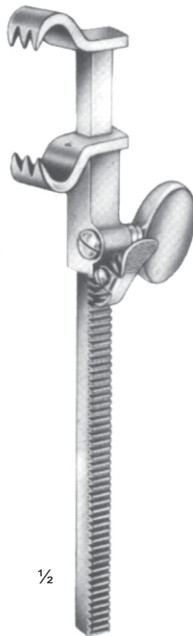

½

**Baily-Gibbon**  
09-080-16  
16 cm / 6¼"

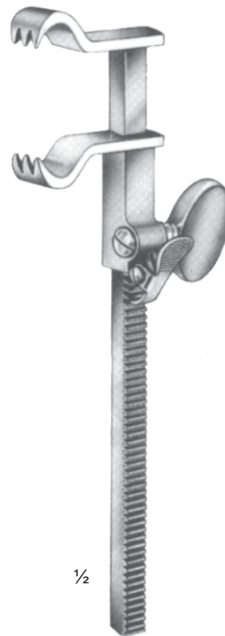

½

**Baily**  
09-081-16  
16 cm / 6¼"



½

**Baily**  
09-082-14 14 cm / 5½"  
09-082-18 18 cm / 7"





[www.krnano.com](http://www.krnano.com)

이비인후과

ENT INSTRUMENTS

Page 168 - 190



Laryngeal Mirror  
10-001-08 8mm  
10-001-10 10mm  
10-001-12 12mm  
10-001-14 14mm  
10-001-16 16mm  
10-001-18 18mm  
10-001-20 20mm  
10-001-22 22mm

10-001-24 24mm  
10-001-26 26mm  
10-001-28 28mm  
10-001-30 30mm

Laryngeal Mirror  
10-002-08 8mm  
10-002-10 10mm  
10-002-12 12mm  
10-002-14 14mm  
10-002-16 16mm  
10-002-18 18mm  
10-002-20 20mm  
10-002-22 22mm  
10-002-24 24mm  
10-002-26 26mm  
10-002-28 28mm  
10-002-30 30mm

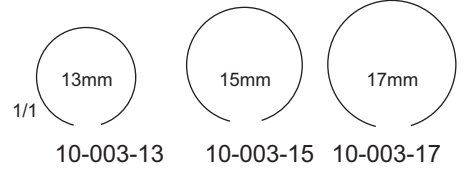

1/1  
13mm 15mm 17mm  
10-003-13 10-003-15 10-003-17



Hartmann  
10-003-13 - 10-003-17

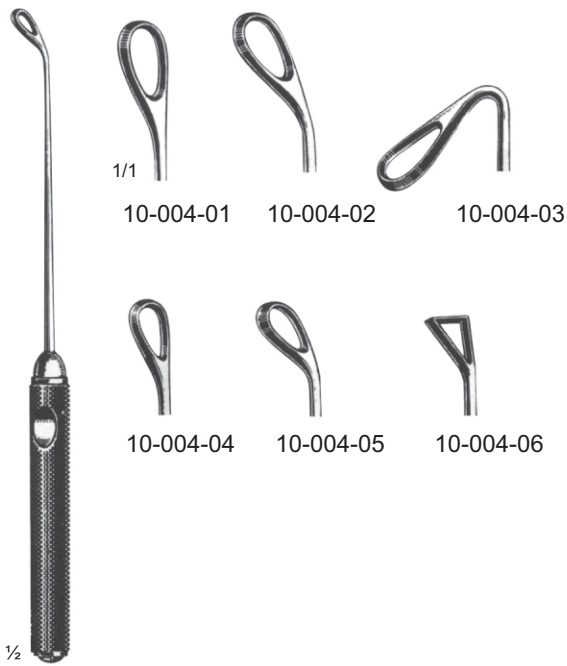

Coakley  
10-004-01 - 10-004-06  
17 cm / 6 1/4"

1/1  
10-004-01 10-004-02 10-004-03  
10-004-04 10-004-05 10-004-06

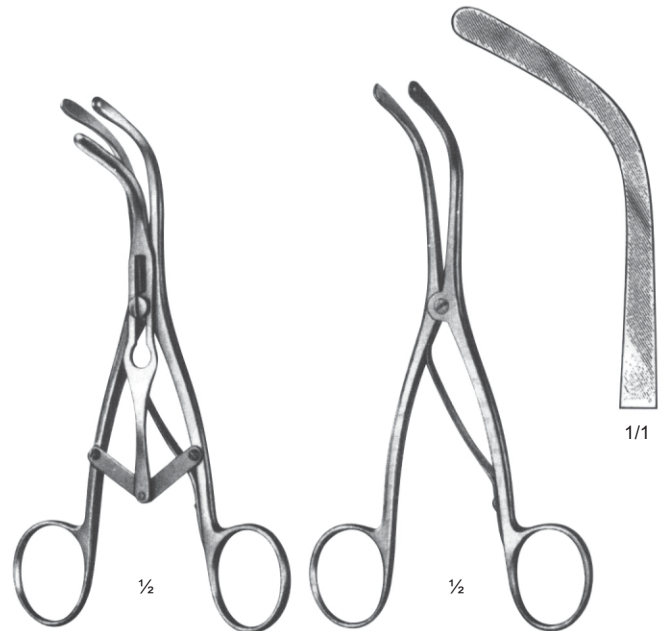

Labarde  
10-005-14  
14 cm / 5 1/2"

Trousseau  
10-006-14  
14 cm / 5 1/2"



White  
10-007-18 18 cm / 7"  
10-007-23 23 cm / 9"

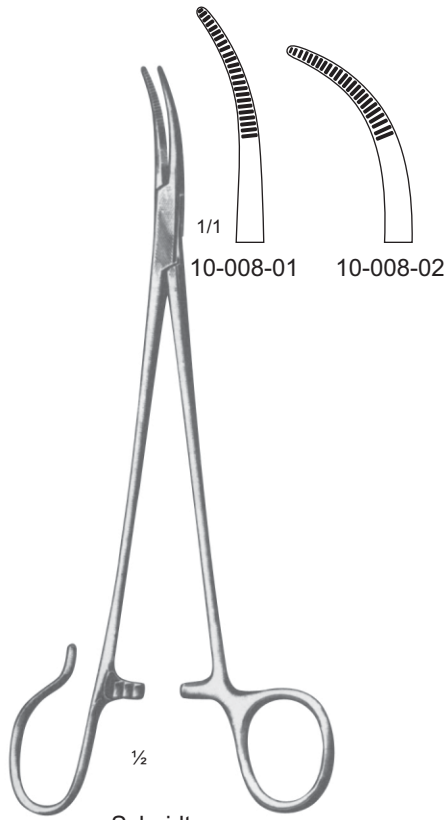

Schnidt  
10-008-01 - 10-008-02  
19 cm / 7½"

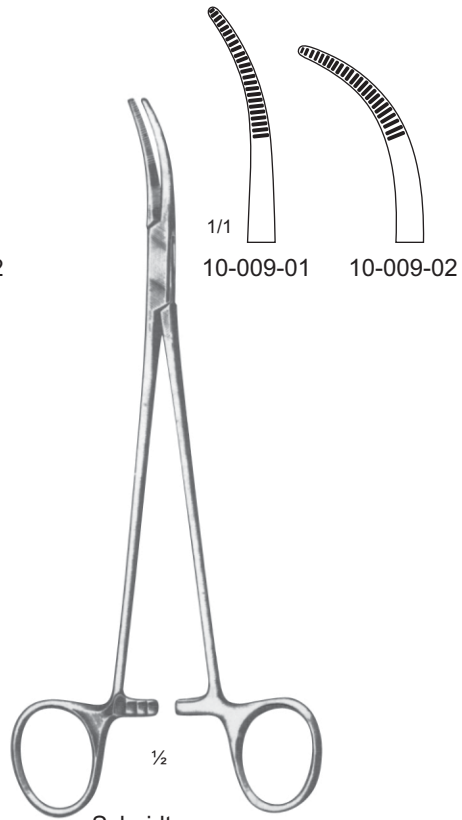

Schnidt  
10-009-01 - 10-009-02  
19 cm / 7½"

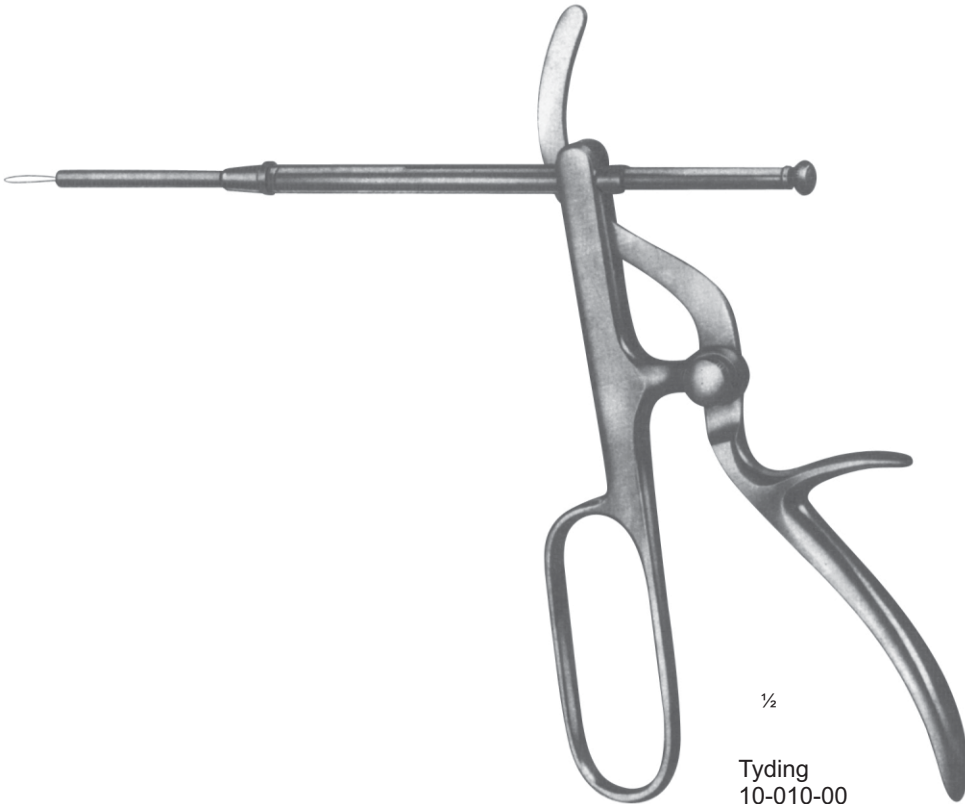

½  
Tyding  
10-010-00



1/3  
Eves  
10-011-28  
28 cm / 11"

1/3  
Eves  
10-012-28  
28 cm / 11"



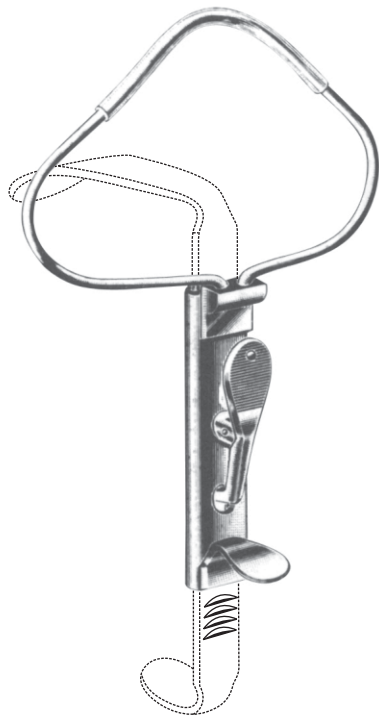

Mclvor (Frame Only)  
10-013-10

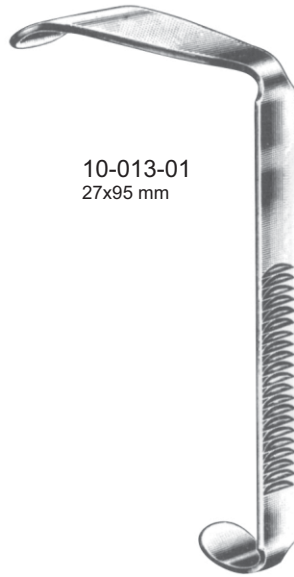

10-013-01  
27x95 mm



10-013-02  
22x85 mm



10-013-03  
22x70 mm

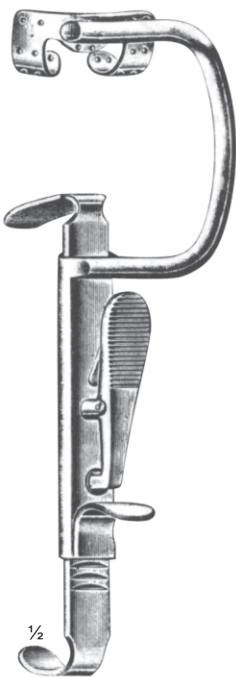

Davis-Boyle (Frame Only)  
10-014-00

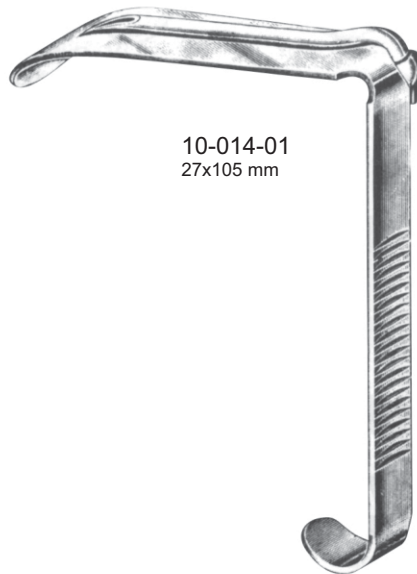

10-014-01  
27x105 mm



10-014-02  
25x90 mm



10-014-03  
25x75 mm



10-014-04  
22x60 mm



10-014-05  
20x25 mm



Jannings  
10-015-09 9 cm / 3 1/2"  
10-015-11 11 cm / 4 1/2"  
10-015-13 13 cm / 5"  
10-015-15 15 cm / 6"



Molt  
10-016-11  
11 cm / 4½"



Molt  
10-017-14  
15 cm / 4½"



Denhart  
10-018-12  
12 cm / 4¾"



1/1  
Obwegeser  
10-019-06 - 10-019-11  
17.5 cm / 7¼"



10-019-06  
6mm



10-019-07  
7mm



10-019-08  
8mm



10-019-11  
11mm



1/1  
10-020-05  
5mm



10-020-07  
7mm

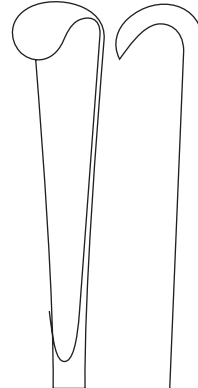

10-020-09  
9mm



1/2  
Obwegeser  
10-020-05 - 10-020-09  
20 cm / 8"





16mm

Tongue Depressor  
10-021-14  
14 cm / 5½"

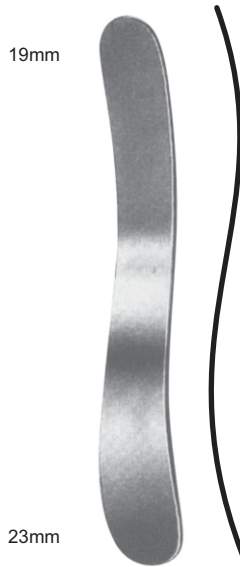

19mm

Tongue Depressor  
10-022-14  
14 cm / 5½"

23mm



Haberer  
10-023-30  
30 cm / 12"



Haberer  
10-024-20  
20 cm / 7"



Wieder  
10-022-00 (Set of 2)  
10-022-28 28mm Blade Serrated  
10-022-36 36mm Blade Serrated  
14 cm / 5½"



Tuffier

- 10-023-13 13x203 mm
- 10-023-16 16x203 mm
- 10-023-19 19x203 mm
- 10-023-25 25x330 mm
- 10-023-38 38x330 mm
- 10-023-61 51x330 mm

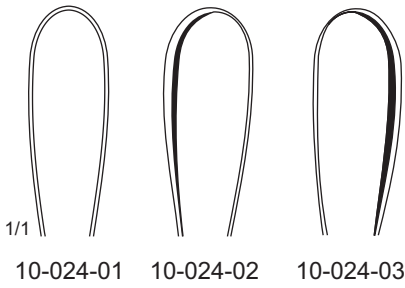

10-024-01 10-024-02 10-024-03



10-026-01 10-026-02 10-026-03



1/2  
Voltolini  
10-026-01 - 10-026-03

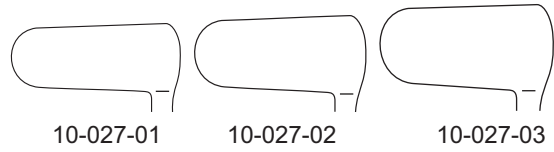

10-027-01 10-027-02 10-027-03



1/2  
Goldsmith (Thudichum)  
10-027-01 - 10-027-03



1/2  
Cottle-Walsham  
10-024-01 - 10-024-03  
23 cm / 9"

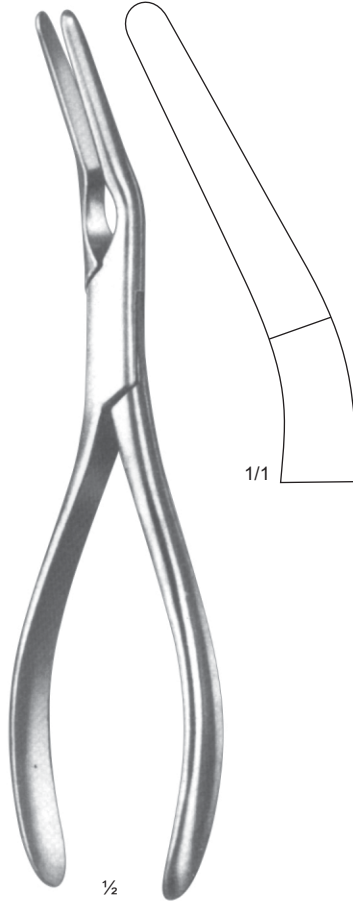

1/2  
Asch  
10-025-01  
23 cm / 9"

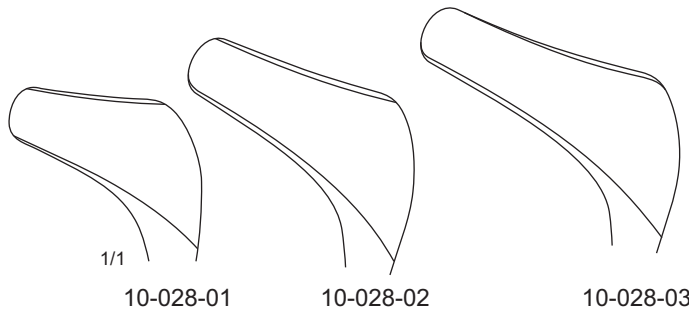

10-028-01 10-028-02 10-028-03



1/2  
Hartmann-Halle  
10-028-01 - 10-028-03  
15 cm / 6"





Mod-Medro  
10-029-13  
13 cm / 5"



Mod-Medro  
10-030-13  
13 cm / 5"



Tieck-Halle  
10-031-13  
13.5 cm / 5 1/4"

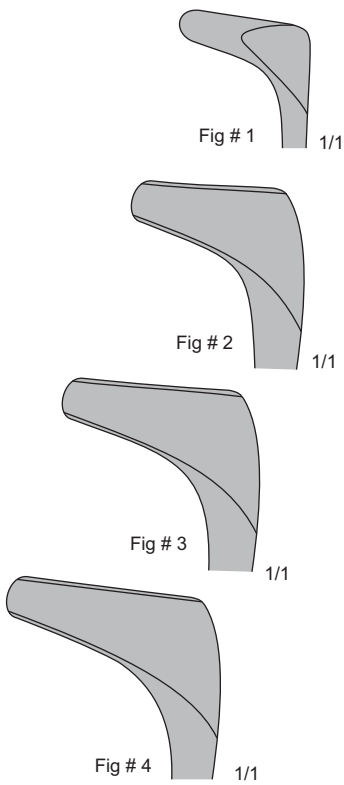

Hartmann  
10-032-01 Fig # 1  
10-032-02 Fig # 2  
10-032-03 Fig # 3  
10-032-04 Fig # 4



Mod-Wien  
10-033-14  
14.5 cm / 5 3/4"



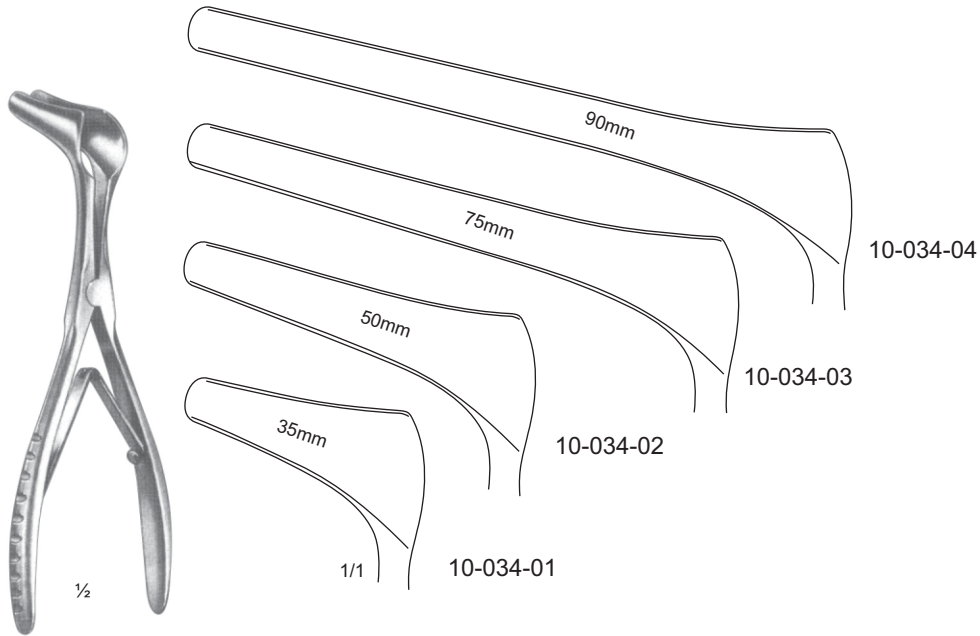

Killian  
10-034-01 - 10-034-04  
13 cm / 5"

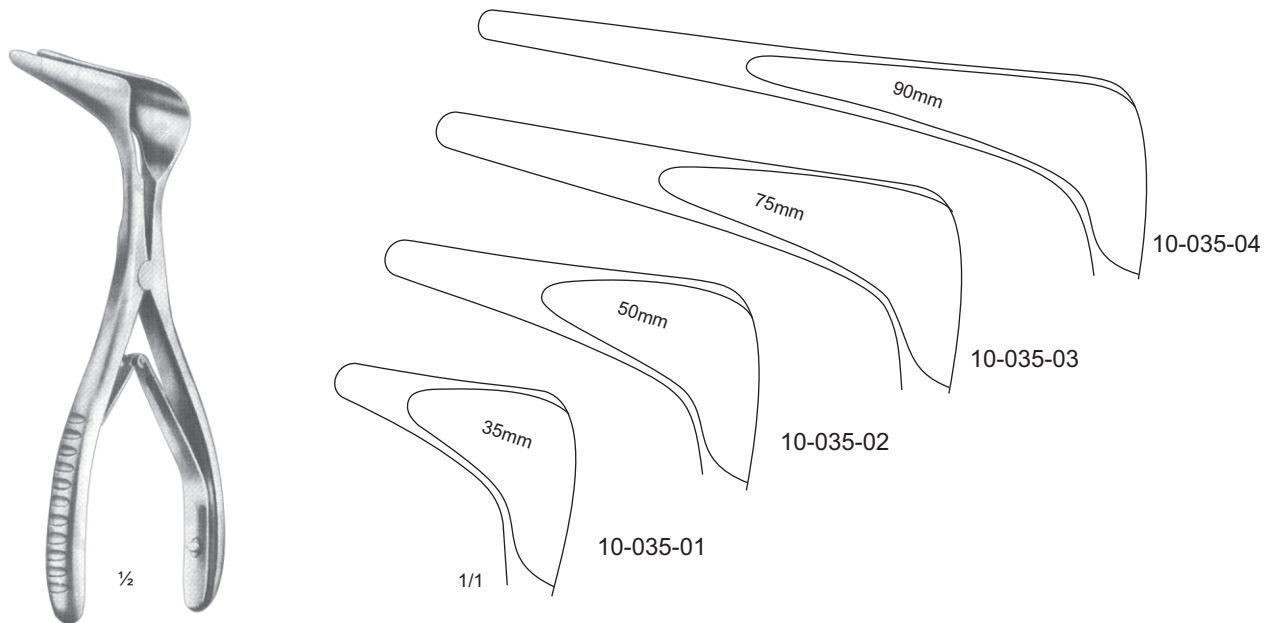

Cottle  
10-035-01 - 10-035-04  
15 cm / 6"





Joseph  
10-036-16  
16 cm / 6 1/4"



Joseph  
10-037-16  
16 cm / 6 1/4"



Freer  
10-038-19  
19 cm / 7 1/2"



Freer  
10-039-18  
18 cm / 7"



Freer  
10-040-20  
20.5 cm / 8"



Ballenger  
10-041-03 - 10-041-05  
20 cm / 8"

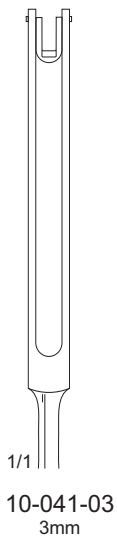

10-041-03  
3mm

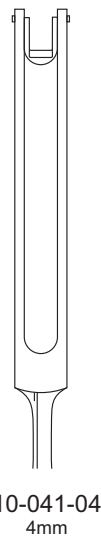

10-041-04  
4mm

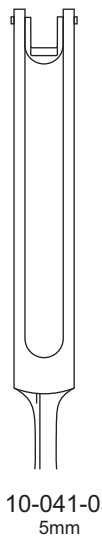

10-041-05  
5mm

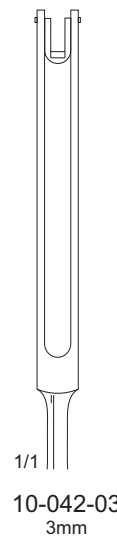

10-042-03  
3mm

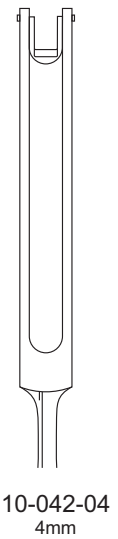

10-042-04  
4mm

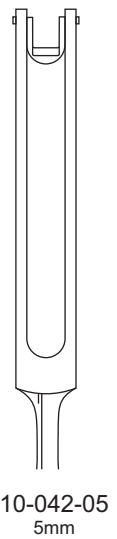

10-042-05  
5mm

Ballenger  
10-042-03 - 10-042-05  
20 cm / 8"



Cottle  
10-043-18  
18 cm / 7"

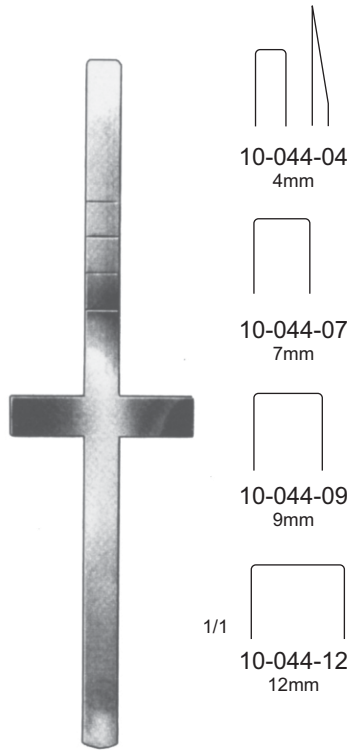

Cottle  
10-044-04 - 10-044-12  
18 cm / 7"

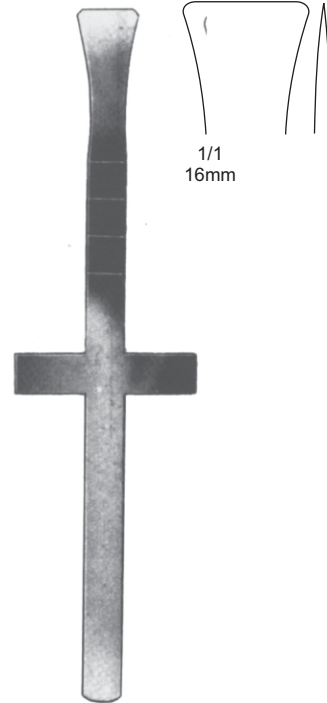

Cottle  
10-045-18  
18 cm / 7"



Cottle  
10-046-18  
18 cm / 7"



Cottle  
10-047-18  
18 cm / 7"

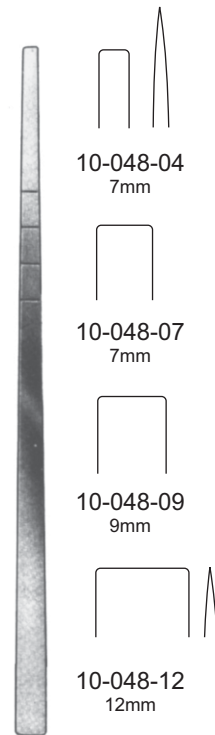

Cottle  
10-047-18 - 10-048-12  
18 cm / 7"



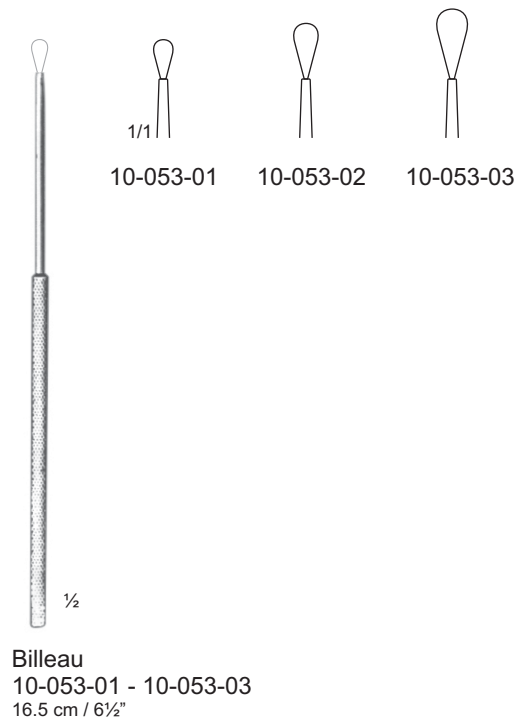
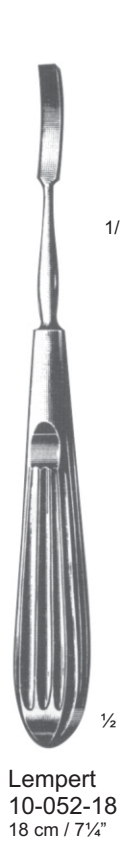
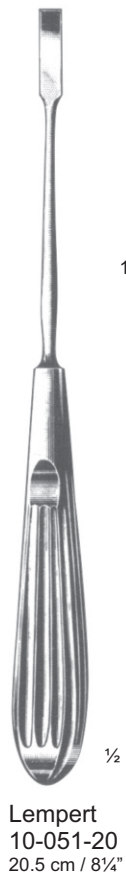
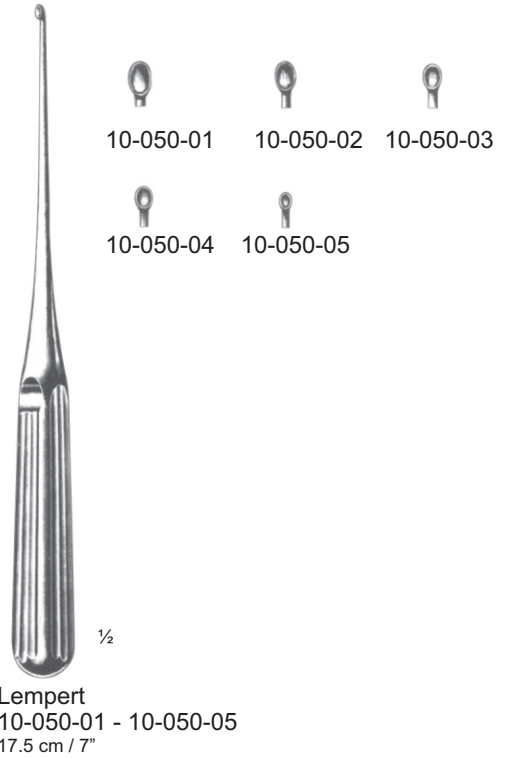
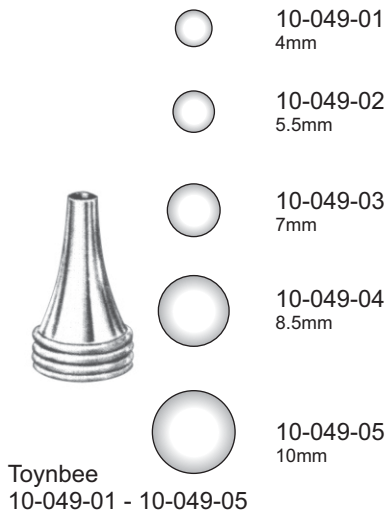



**Buck**  
10-054-01 - 10-054-14  
16.5 cm / 6½"

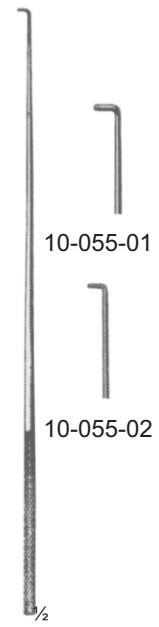
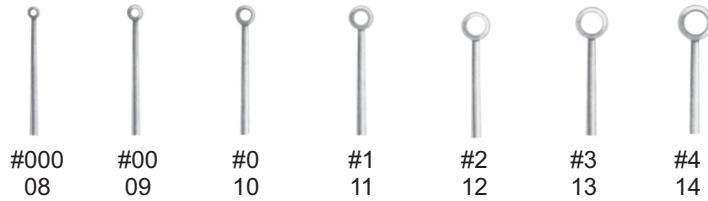
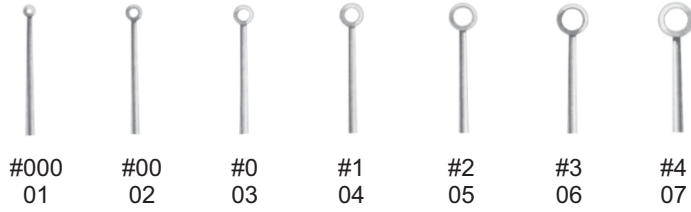

**Day**  
10-055-01 - 10-055-02  
16.5 cm / 6½"

10-055-01  
10-055-02

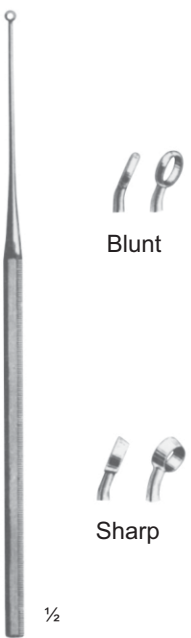

**Buck**  
10-056-01 - 10-056-14  
16.5 cm / 6½"

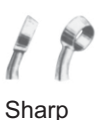



**Buck**  
10-057-15  
15 cm / 6"



**Politzer**  
10-058-16  
16 cm / 6½"

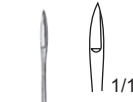

**Sexton**  
10-059-18  
18 cm / 7¼"



**Sexton**  
10-060-17  
17 cm / 6¾"



**Gerzog-Sexton**  
10-061-17  
17 cm / 6¾"



**Politzer**  
10-062-16  
16 cm / 6½"



**Politzer**  
10-063-16  
16.5 cm / 6½"



**Politzer**  
10-064-16  
16.5 cm / 6½"



**Lucae**  
10-065-18  
18 cm / 7¼"



**Lucae**  
10-066-18  
18 cm / 7¼"



Metal-Alloy  
10-067-10  
c128



Metal-Alloy  
10-068-11  
c256

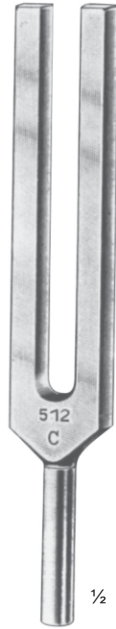

Metal-Alloy  
10-069-12  
c512



Metal-Alloy  
10-070-13  
c1024



Metal-Alloy  
10-071-14  
c2048

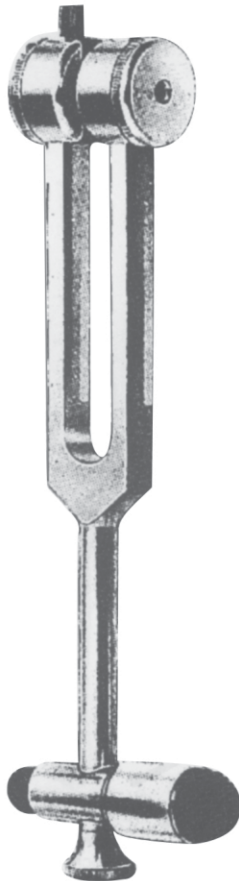

10-072-00



Tuning Folk Set of 5  
10-073-00



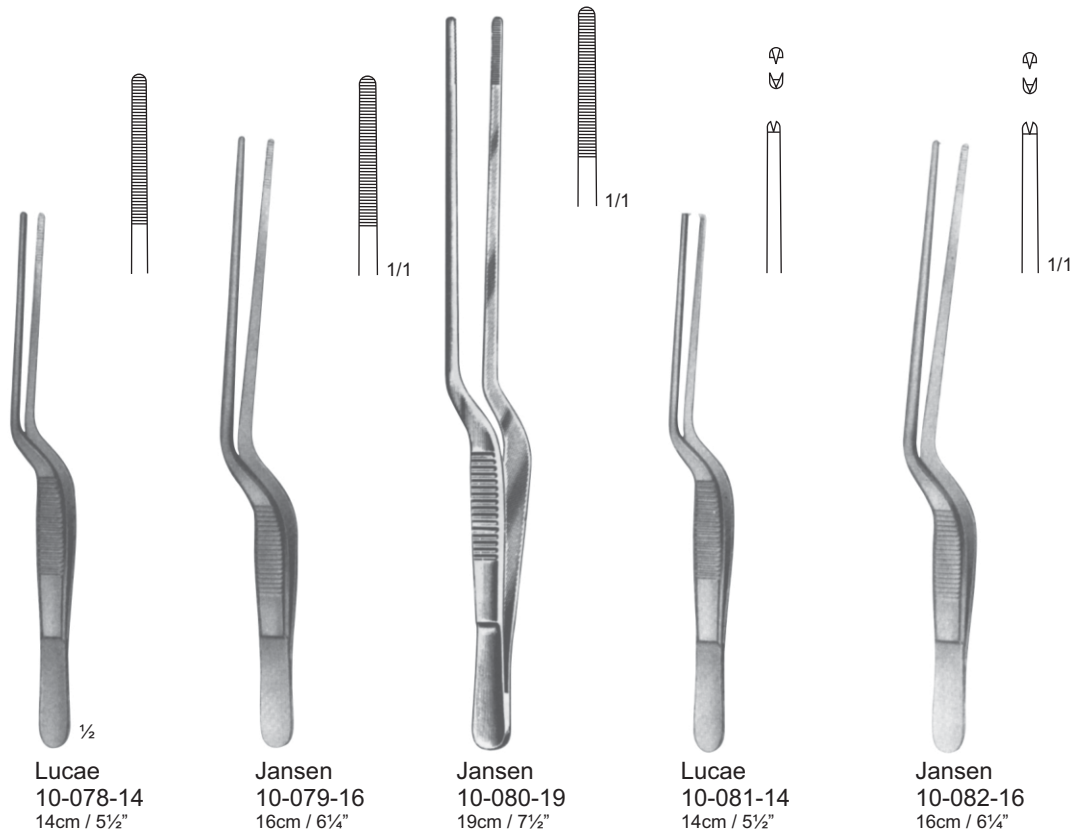
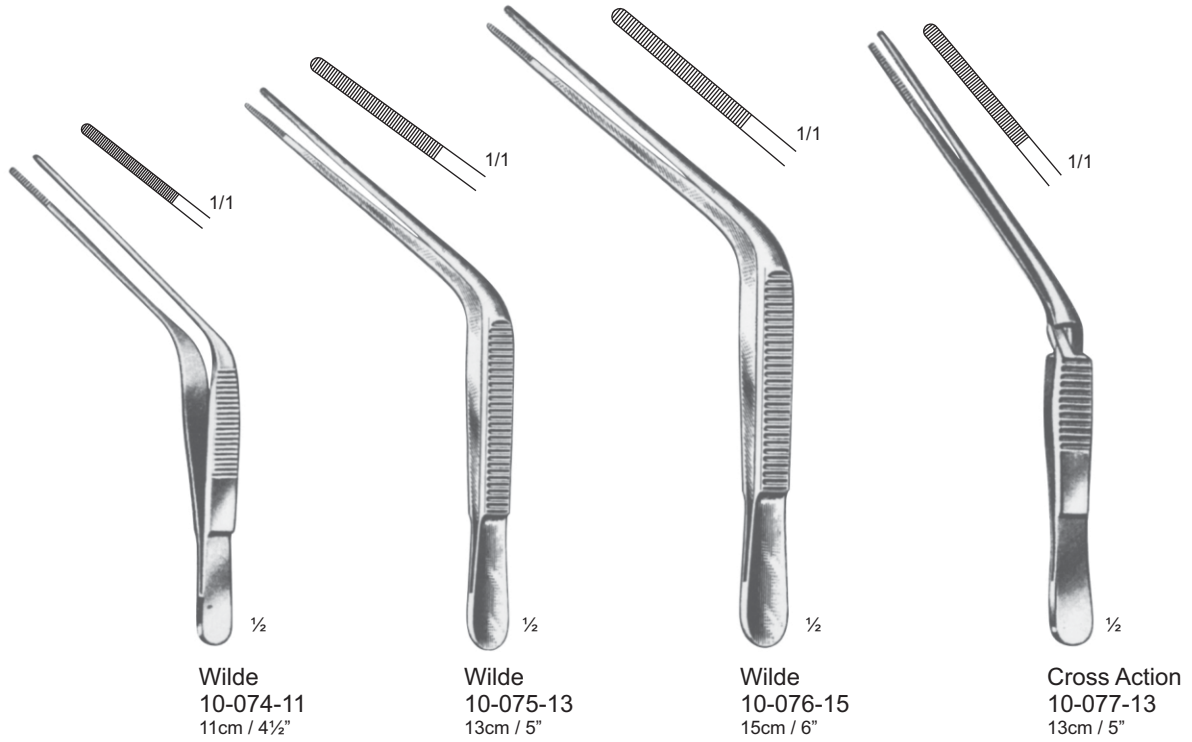



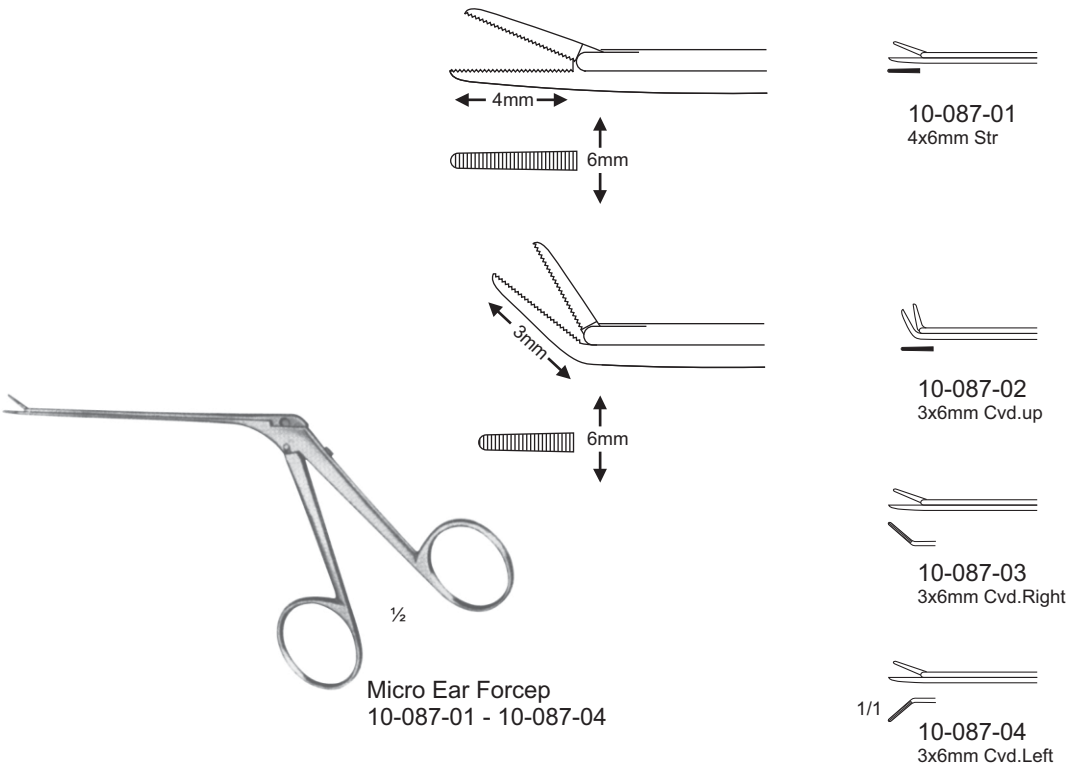
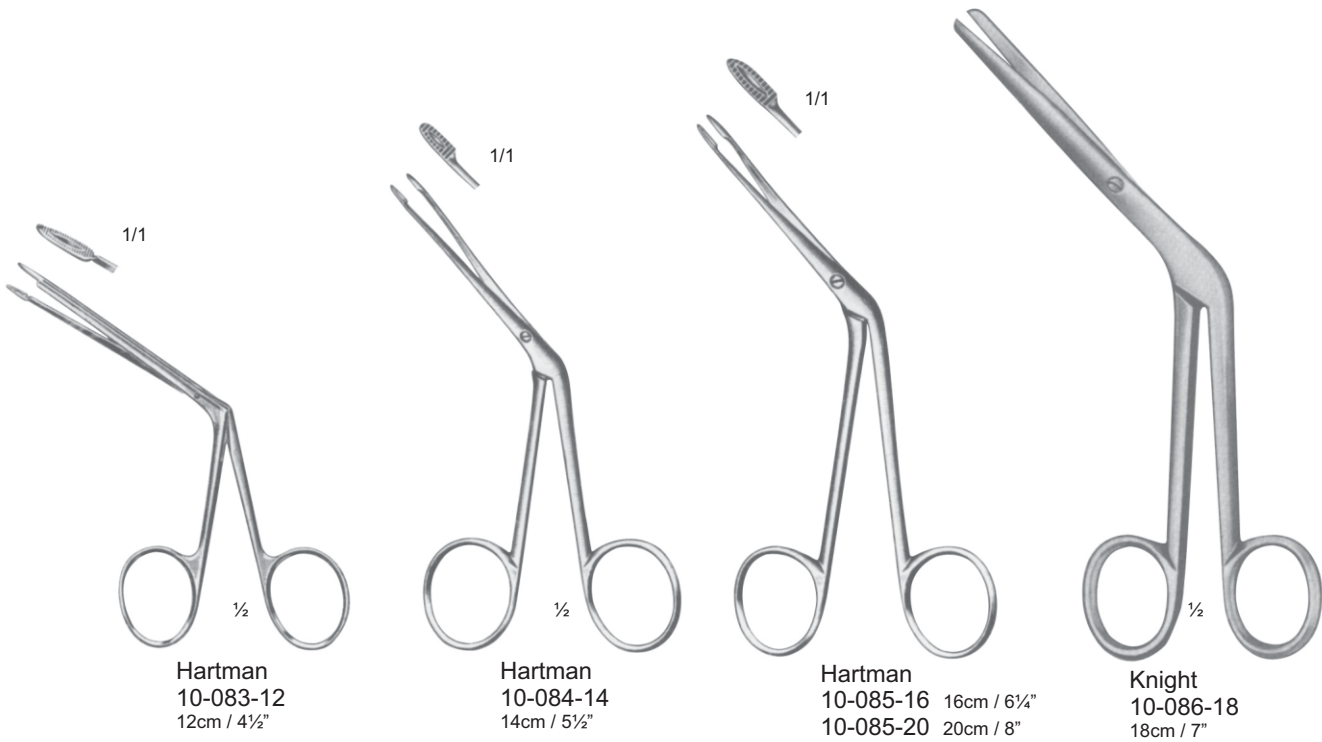

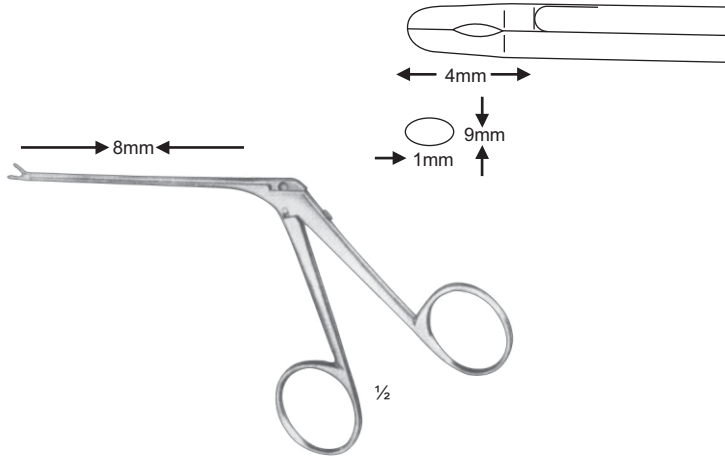

10-088-01 - 10-088-04  
8cm / 3 1/4"

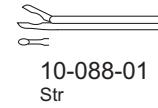

10-088-01  
Str

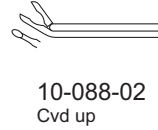

10-088-02  
Cvd up

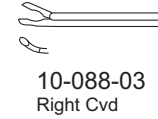

10-088-03  
Right Cvd

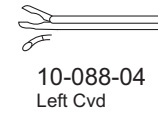

10-088-04  
Left Cvd

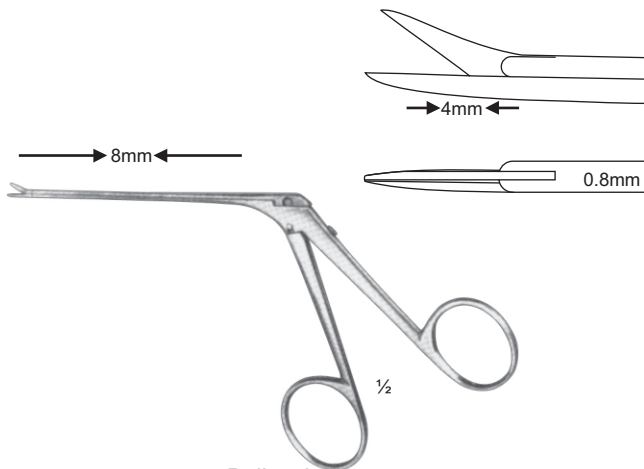

Bellucci  
10-089-01 - 10-089-04  
8cm / 3 1/4"

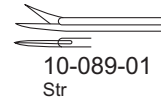
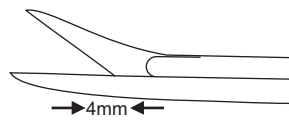

10-089-01  
Str

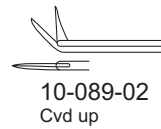

10-089-02  
Cvd up

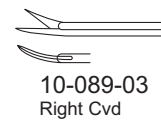

10-089-03  
Right Cvd

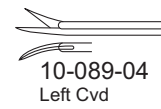

10-089-04  
Left Cvd

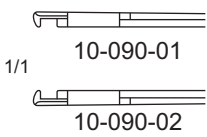

10-090-01  
10-090-02

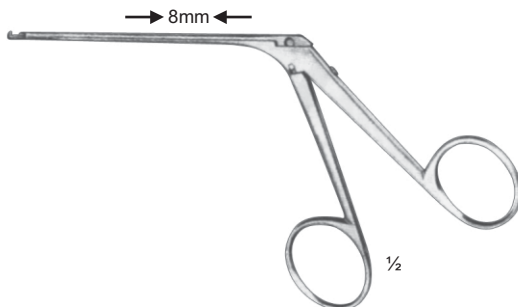

House-Dieter  
10-090-01 - 10-090-02  
8cm / 3 1/4"

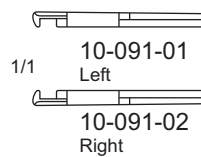

10-091-01  
Left  
10-091-02  
Right



House-Dieter  
10-091-01 - 10-091-02  
8cm / 3 1/4"

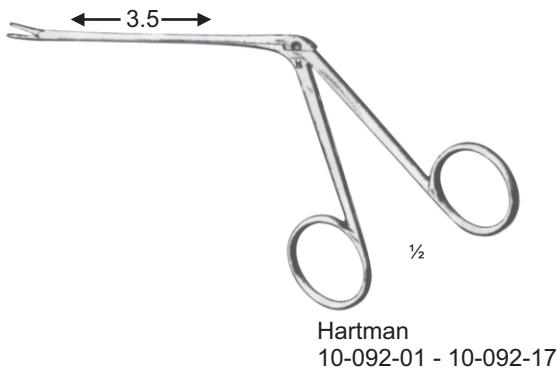
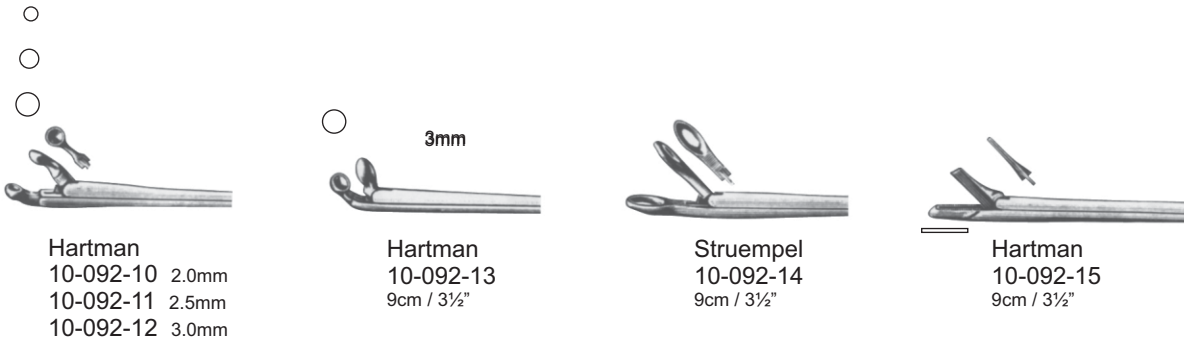
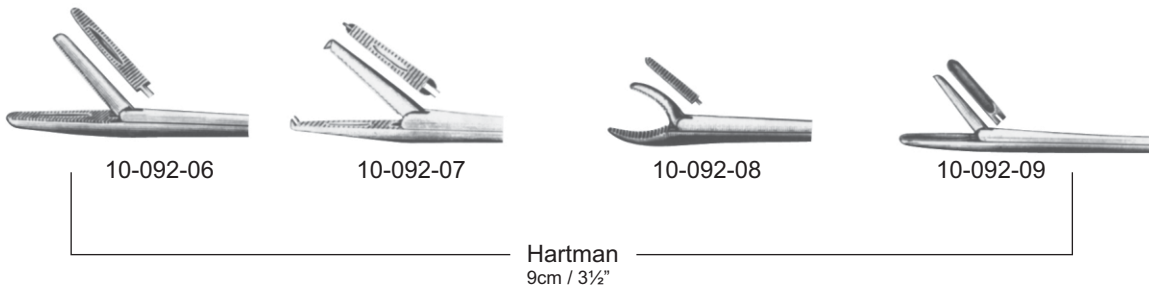
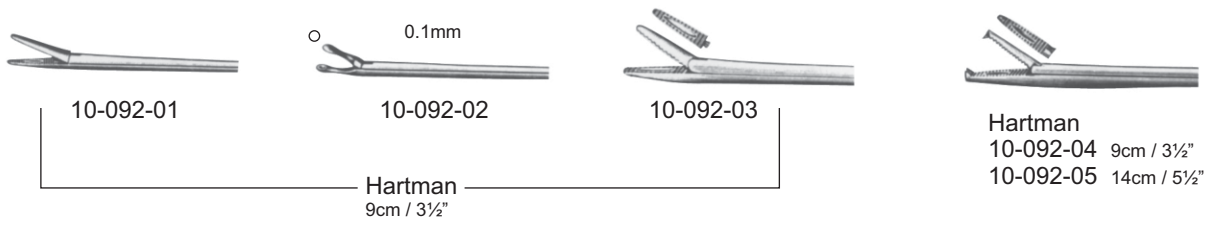



1/1



1/2

**Ochsner**  
10-094-01 Ø4.5mm  
10-094-02 Ø5.5mm  
10-094-03 Ø6.5mm  
10-094-04 Ø7.5mm



1/1

10-095-02 Ø2mm  
10-095-03 Ø3mm  
10-095-04 Ø4mm



10-096-01 #1  
10-096-02 #2  
10-096-03 #3  
10-096-04 #4



**Randall**  
10-093-10  
240mm / 9 3/4"



**Novak-Schoeckaert**  
10-095-02 - 10-095-04  
240mm / 9 3/8"



1/2

**Adson Str**  
10-097-01  
21cm / 8 1/4"



1/2

**Adson Cvd**  
10-097-02  
21cm / 8 1/4"



**Frazier Str**  
10-097-06 Fr.  
10-097-07 Fr.  
10-097-08 Fr.  
10-097-09 Fr.  
10-097-10 Fr.  
10-097-11 Fr.  
10-097-12 Fr.  
13cm / 5"



**Frazier Cvd**  
10-098-06 Fr.  
10-098-07 Fr.  
10-098-08 Fr.  
10-098-09 Fr.  
10-098-10 Fr.  
10-098-11 Fr.  
10-098-12 Fr.  
13cm / 5"



**Fergusson**  
10-099-06 Fr.  
10-099-07 Fr.  
10-099-08 Fr.  
10-099-09 Fr.  
10-099-10 Fr.  
10-099-11 Fr.  
10-099-12 Fr.  
13cm / 5"

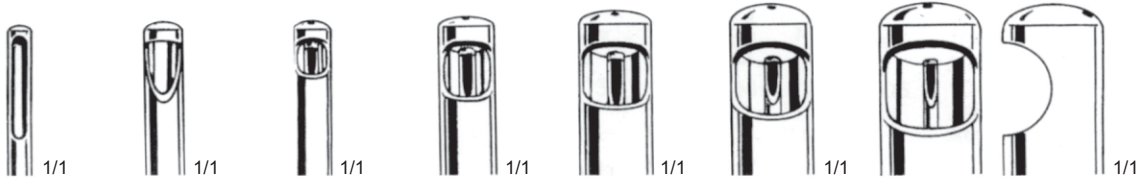

10-100-01  
28cm / 11"  
4mm

10-100-02  
28cm / 11"  
3mm

10-100-03  
28cm / 11"  
4.5mm

10-100-04  
28cm / 11"  
6mm

10-100-05  
28cm / 11"  
8mm

10-100-06  
28cm / 11"  
10mm

10-100-07  
28cm / 11"  
14mm

10-100-08  
10cm / 4"  
10mm



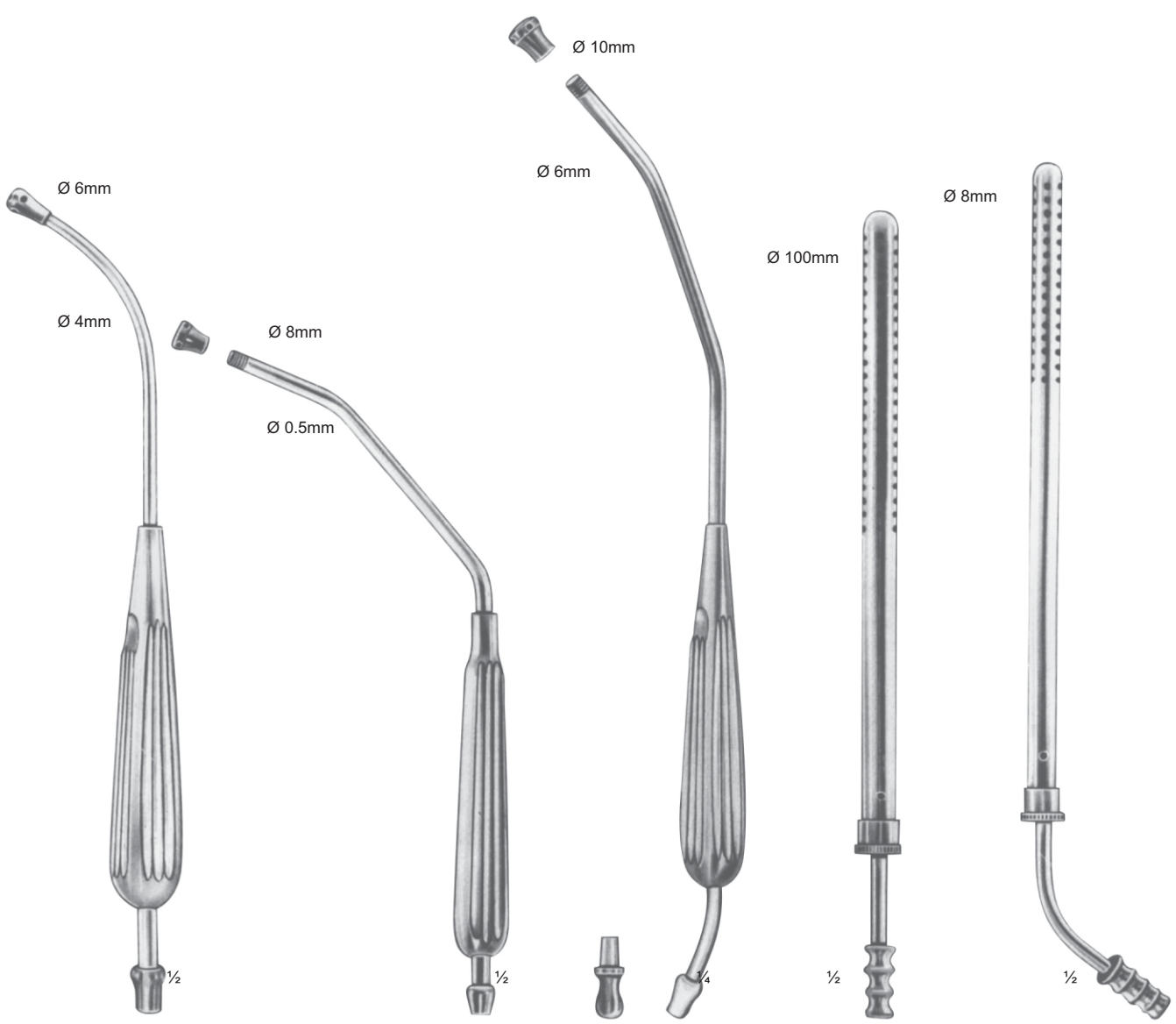
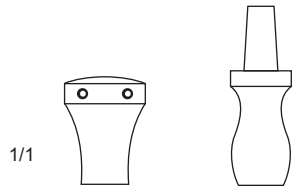

Andrew Pynchon  
10-101-24  
24cm / 9½"

Yankaur Child  
10-102-21  
21cm / 8¼"

Yankaur  
10-103-29  
29cm / 11½"

Poole  
10-104-24  
24cm / 9¼"

Poole  
10-105-25  
25cm / 10"



1/1  
10-106-01  
1mm  
29cm / 11¼"

10-107-02  
2mm  
29cm / 11¼"

10-108-03  
21cm / 8¼"  
10-109-03  
29cm / 11¼"  
3mm

10-110-04  
21cm / 8¼"  
10-111-04  
29cm / 11¼"  
4mm

10-112-05  
21cm / 8¼"  
10-113-05  
29cm / 11¼"  
5mm

10-114-06  
21cm / 8¼"  
10-115-06  
29cm / 11¼"  
6mm

10-116-07  
21cm / 8¼"  
10-117-07  
29cm / 11¼"  
7mm

1/1  
10-118-08  
21cm / 8¼"  
10-119-08  
29cm / 11¼"  
8mm

10-120-09  
21cm / 8¼"  
10-121-09  
29cm / 11¼"  
9mm

10-122-10  
21cm / 8¼"  
10-123-10  
29cm / 11¼"  
10mm

10-124-10  
21cm / 8¼"  
10-125-10  
29cm / 11¼"  
11mm

10-126-12  
21cm / 8¼"  
10-127-12  
29cm / 11¼"  
12mm

10-128-13  
21cm / 8¼"  
10-129-13  
29cm / 11¼"  
13mm

Bakes  
10-106-01 - 10-126-13  
21cm / 8¼"



10-130-11 11cm / 4½"  
10-130-13 13cm / 5"  
10-130-14 14cm / 5½"  
10-130-15 15cm / 6"  
10-130-18 18cm / 7"  
10-130-20 20cm / 8"



10-131-11 11cm / 4½"  
10-131-13 13cm / 5"  
10-131-14 14cm / 5½"  
10-131-15 15cm / 6"  
10-131-18 18cm / 7"  
10-131-20 20cm / 8"



10-132-11 11cm / 4½"  
10-132-13 13cm / 5"  
10-132-14 14cm / 5½"  
10-132-15 15cm / 6"  
10-132-18 18cm / 7"  
10-132-20 20cm / 8"



10-133-11 11cm / 4½"  
10-133-13 13cm / 5"  
10-133-14 14cm / 5½"  
10-133-15 15cm / 6"  
10-133-18 18cm / 7"  
10-133-20 20cm / 8"





10-134-11 11cm / 4½"  
10-134-13 13cm / 5"  
10-134-14 14cm / 5½"  
10-134-15 15cm / 6"  
10-134-18 18cm / 7"  
10-134-20 20cm / 8"  
10-134-23 23cm / 9"  
10-134-25 25cm / 10"



10-135-11 11cm / 4½"  
10-135-13 13cm / 5"  
10-135-14 14cm / 5½"  
10-135-15 15cm / 6"  
10-135-18 18cm / 7"  
10-135-20 20cm / 8"  
10-135-23 23cm / 9"  
10-135-25 25cm / 10"



10-136-11 11cm / 4½"  
10-136-13 13cm / 5"  
10-136-14 14cm / 5½"  
10-136-15 15cm / 6"  
10-136-18 18cm / 7"  
10-136-20 20cm / 8"  
10-136-23 23cm / 9"  
10-136-25 25cm / 10"



10-137-11 11cm / 4½"  
10-137-13 13cm / 5"  
10-137-14 14cm / 5½"  
10-137-15 15cm / 6"  
10-137-18 18cm / 7"  
10-137-20 20cm / 8"  
10-137-23 23cm / 9"  
10-137-25 25cm / 10"



10-138-11 11cm / 4½"  
10-138-13 13cm / 5"  
10-138-14 14cm / 5½"  
10-138-15 15cm / 6"  
10-138-18 18cm / 7"  
10-138-20 20cm / 8"  
10-138-23 23cm / 9"  
10-138-25 25cm / 10"



10-139-11 11cm / 4½"  
10-139-13 13cm / 5"  
10-139-14 14cm / 5½"  
10-139-15 15cm / 6"  
10-139-18 18cm / 7"  
10-139-20 20cm / 8"  
10-139-23 23cm / 9"  
10-139-25 25cm / 10"



10-140-11 11cm / 4½"  
10-140-13 13cm / 5"  
10-140-14 14cm / 5½"  
10-140-15 15cm / 6"  
10-140-18 18cm / 7"  
10-140-20 20cm / 8"  
10-140-23 23cm / 9"  
10-140-25 25cm / 10"





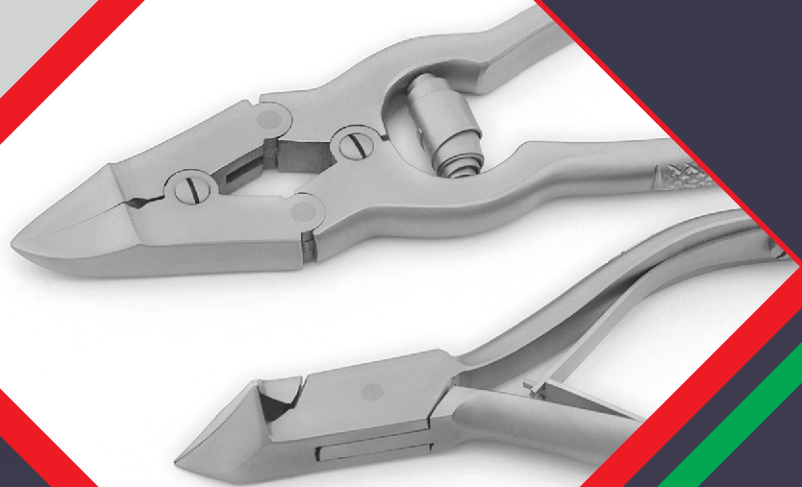

[www.krnano.com](http://www.krnano.com)

피부 / 항문외과

DERMAL & RECTAL INSTRUMENTS

Page 192 - 196



1/2 1/1  
**Unna**  
11-001-14  
14cm / 5½"



1/2 1/1  
**Unna**  
11-002-14  
14cm / 5½"



1/2 1/1  
**Saalfeld**  
11-003-14  
14cm / 5½"



1/2 1/1  
**Saalfeld**  
11-004-10  
10cm / 4"



1/2 1/1  
**Katsch**  
11-005-14  
14cm / 5½"

1/1  
Gold Cap  
Also Available

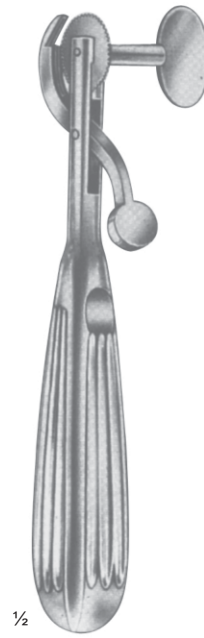

1/2  
**Finger Ring Cutter**  
11-006-16  
16cm / 6¼"



1/2

Nail Cutter  
11-007-14 14cm / 5½"  
11-007-16 14cm / 5¼"



1/2

Nail Cutter  
11-008-13  
13cm / 5"



1/2

Nail Cutter  
11-009-14  
14cm / 5½"



Turnbull  
11-010-11 11cm / 4½"  
11-010-13 13cm / 5"



1/1

Nail Nippers  
11-011-11 11cm / 4½"  
11-011-13 13cm / 5"  
11-011-15 15cm / 6"

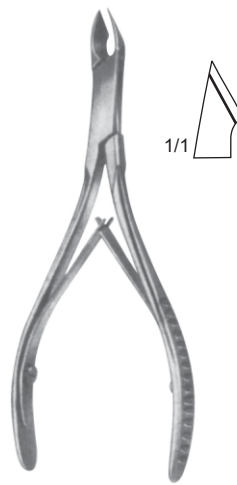

1/1

Nail Nippers  
11-012-11 11cm / 4½"  
11-012-13 13cm / 5"



1/2

Nail Nippers  
11-013-10 10cm / 4¼"





Haemorrhoidal  
11-014-01 Cvd

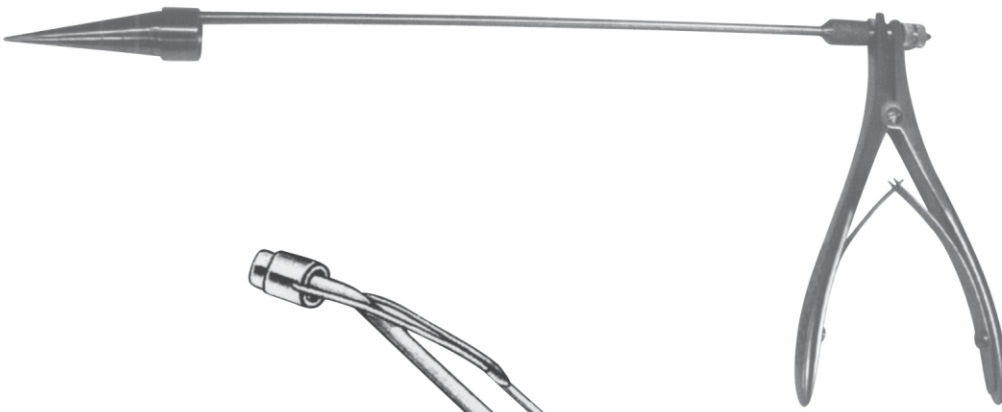

Haemorrhoidal  
11-014-02 str



Mc Givney  
11-015-18  
18.5cm / 7 1/4"



Haemorrhoida Suction Ligatori  
11-016-00



**Cuticle**  
 10cm / 4"

Str 11-017-10  
 Cvd 11-018-10

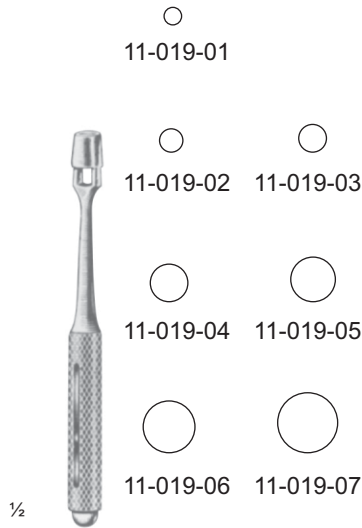

**Keys**  
 11-019-01 - 11-019-07  
 11cm / 4½"

11-019-01  
 11-019-02 11-019-03  
 11-019-04 11-019-05  
 11-019-06 11-019-07

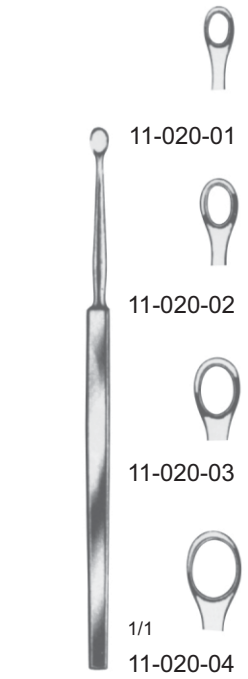

**Fox**  
 11-020-01 - 11-020-04  
 14cm / 5½"

11-020-01  
 11-020-02  
 11-020-03  
 11-020-04



**Pratt**  
 11-021-15  
 15cm / 6"



**Sims**  
 11-022-15  
 15cm / 6"

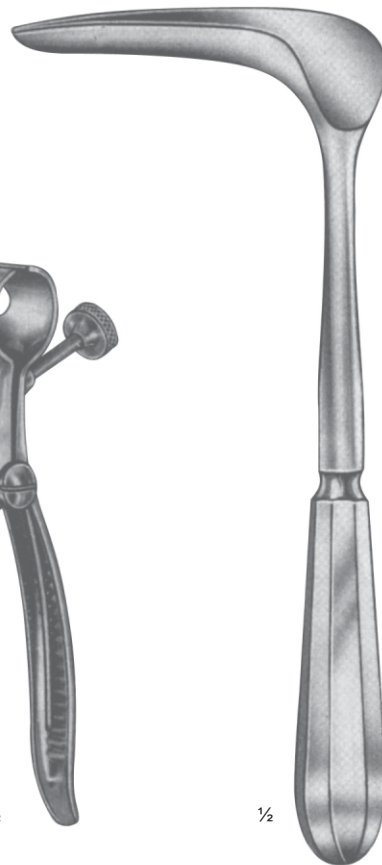

**Czerny**  
 11-023-21  
 21cm / 8¾"





½  
**Mathieu**  
11-024-20  
20cm / 7¾"



70 x 22 mm  
½  
**Barr**  
11-025-17  
17cm / 6¾"



½  
**Hirschmann Anoscope**  
11-026-01 14x64mm  
11-026-02 17x70mm  
11-026-03 20x89mm



**Ives-Fansler Anoscope**  
11-027-14  
14.5mm / 5¾"



[www.krnano.com](http://www.krnano.com)

정형외과

ORTHOPEDIC INSTRUMENTS

Page 198 - 236



**Giertz - Stille**  
12-001-27  
27cm / 10½"

1/3



12-002-20  
20cm / 8"

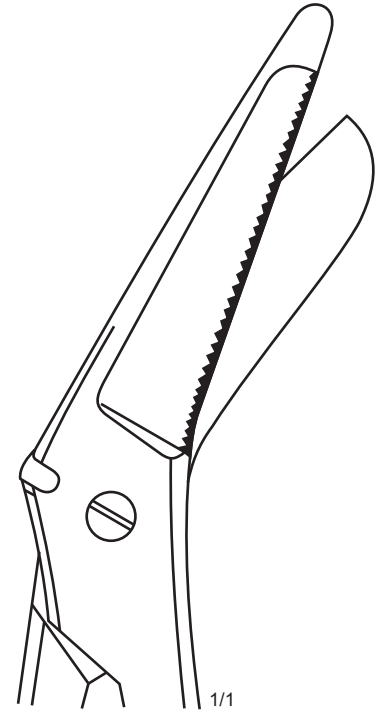

1/1



12-003-22  
22cm / 8¾"

½



**Gluck**  
12-004-22  
22cm / 8¾"

½



**Wolff**  
12-005-18 - 12-005-24

½



1/1

12-005-18  
18cm / 7"

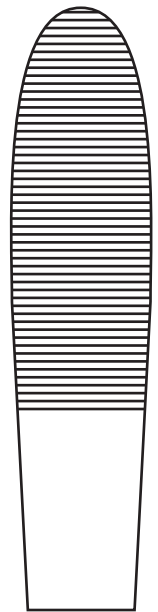

12-005-24  
24cm / 9½"





Henning  
12-006-28  
28cm / 11"

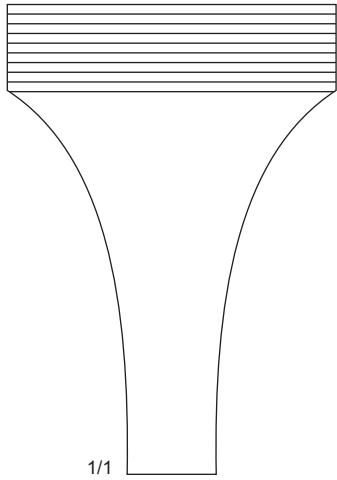

1/1

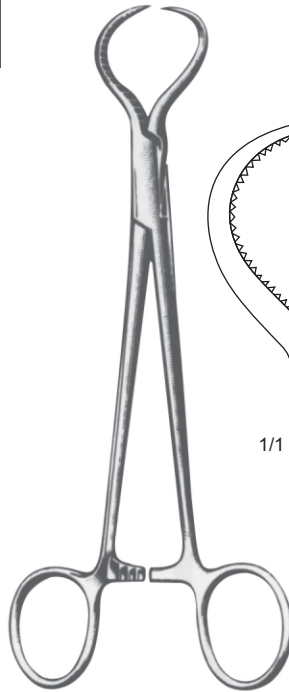

Lewin  
12-006-18  
18cm / 7"

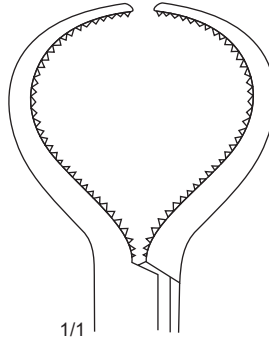

1/1

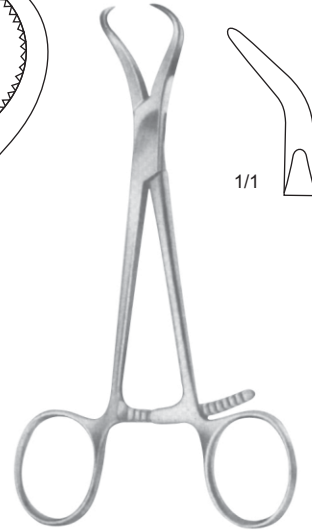

Finger Reposition Forceps  
12-006-13  
13cm / 5 1/4"

1/1

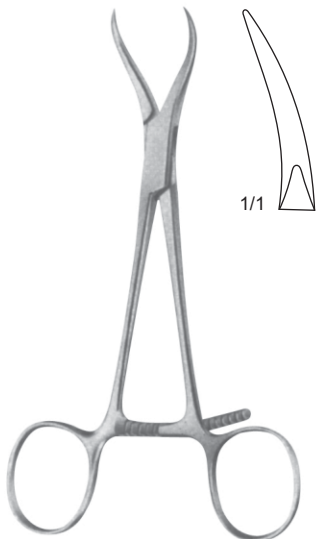

Finger Reposition Forceps  
12-006-14  
13cm / 5 1/4"

1/1

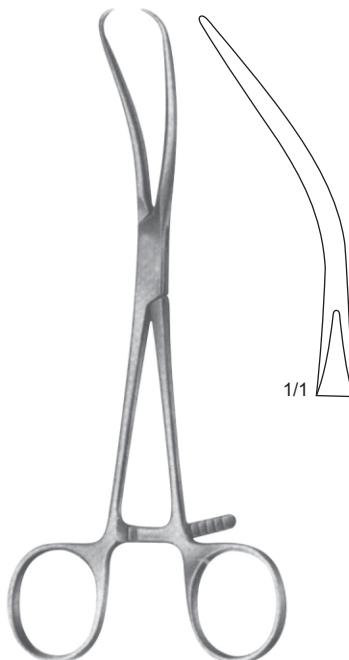

REILL Reposition Forceps  
12-007-17  
17cm / 6 3/4"

1/1

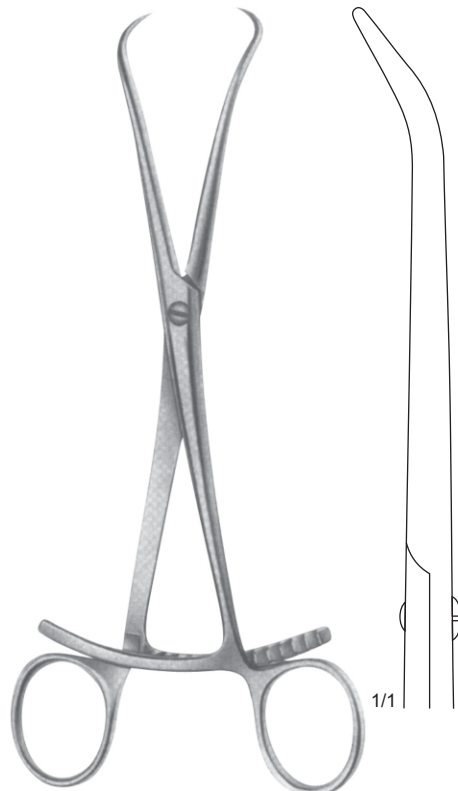

Bone Reposition Forceps  
12-008-20  
20cm / 8"

1/1





**Lowman Modif**  
12-009-12 12cm / 4¾"  
12-009-18 18cm / 7"  
12-009-20 20cm / 8"  
12-009-22 22cm / 8¾"

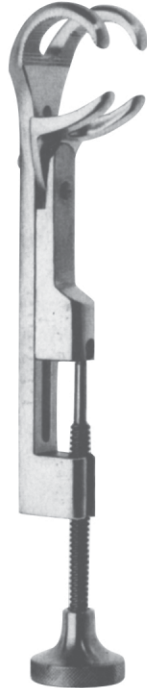

**Lowman**  
12-010-18  
18cm / 7"



**Lowman**  
12-011-12 12cm / 4¾"  
12-011-18 18cm / 7"  
12-011-20 20cm / 8"



**Kern Without Ratchet**  
12-012-14 - 12-013-22



1/1  
12-012-14 14cm / 5½"  
12-013-22 22cm / 8¾"

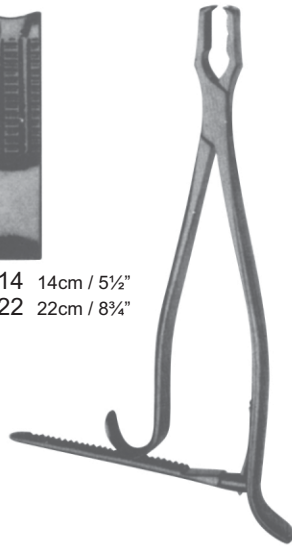

**Kern Without Ratchet**  
12-014-14 14cm / 5½"  
12-014-22 22cm / 8¾"



1/1  
12-014-33 33cm / 13"  
12-014-43 43cm / 17"  
12-014-33 33cm / 13"  
12-014-43 43cm / 17"

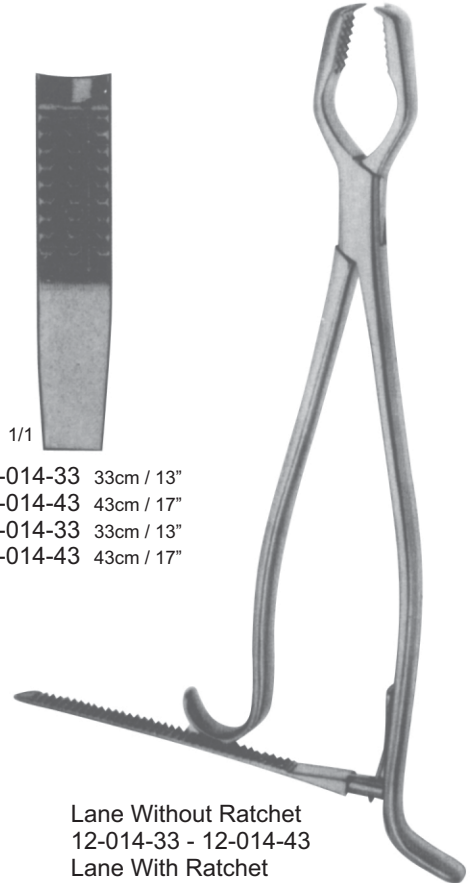

**Lane Without Ratchet**  
12-014-33 - 12-014-43  
**Lane With Ratchet**  
12-015-33 - 12-015-43

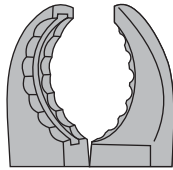
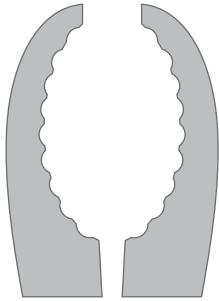

12-016-23  
23cm / 9"

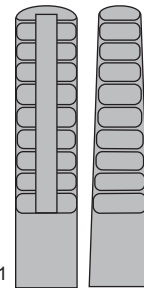
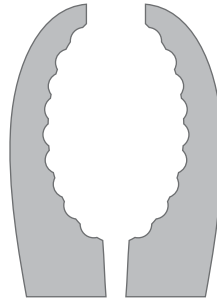

1/1  
12-019-23 23cm / 9"  
12-020-26 26cm / 10"  
12-021-28 28cm / 11"

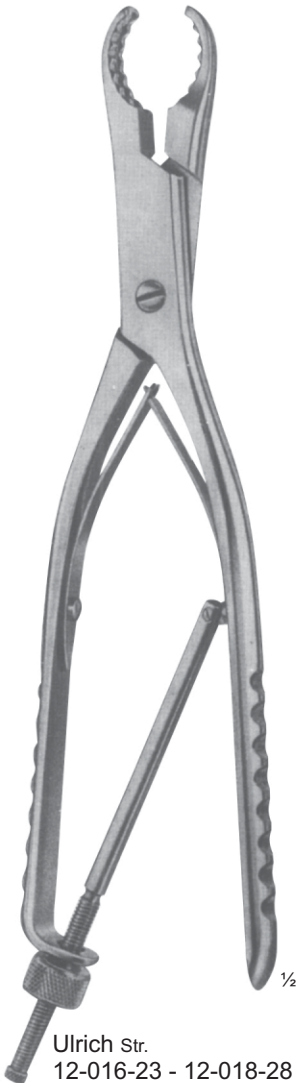

Ulrich Str.  
12-016-23 - 12-018-28

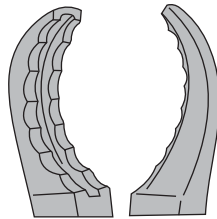

12-017-25  
25cm / 10"

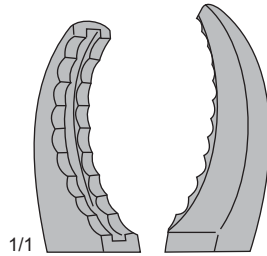

1/1  
12-018-28  
28cm / 11"



Ulrich Cvd.  
12-019-23 - 12-021-28





Farabeuf-Lambotte Forceps  
12-022-25  
25cm / 10"



Farabeuf Forceps  
12-023-25  
25cm / 10"

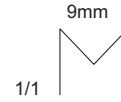

Farabeuf Forceps  
12-024-23  
23cm / 9"

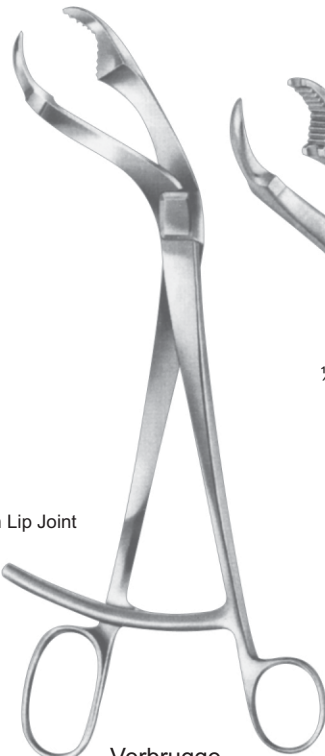

With Lip Joint

Verbrugge  
12-025-25 - 12-027-27

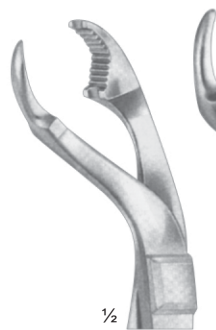

12-025-25  
25cm / 10"

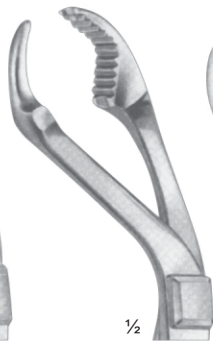

12-026-26  
26cm / 10"



12-027-27  
27cm / 10½"

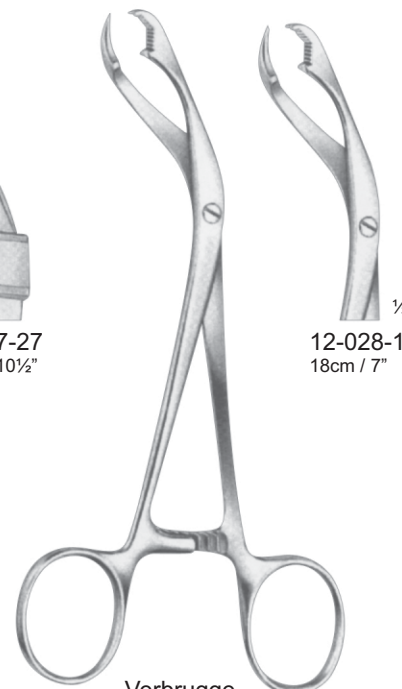

Verbrugge  
12-028-18

12-028-18  
18cm / 7"

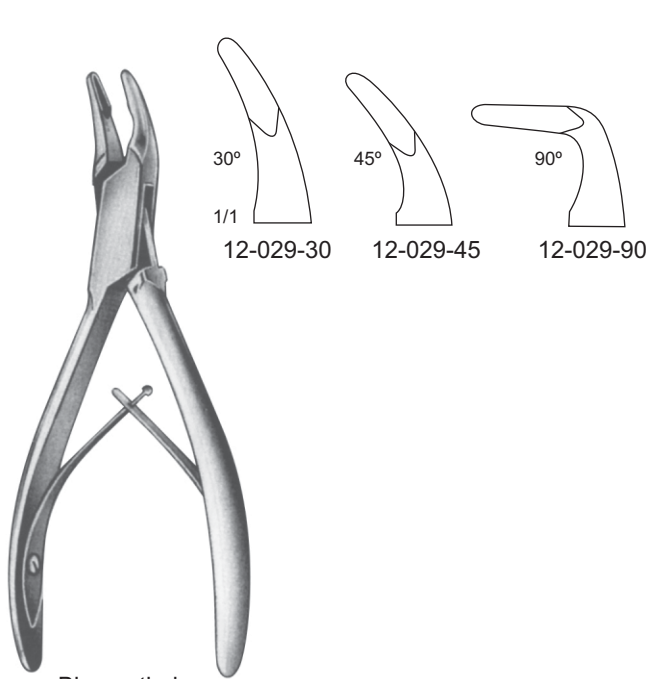

Blumenthal  
12-029-30 - 12-029-90  
16cm / 6½"

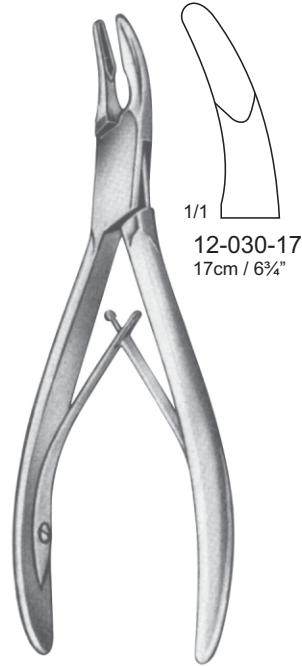

Hartman  
12-030-17

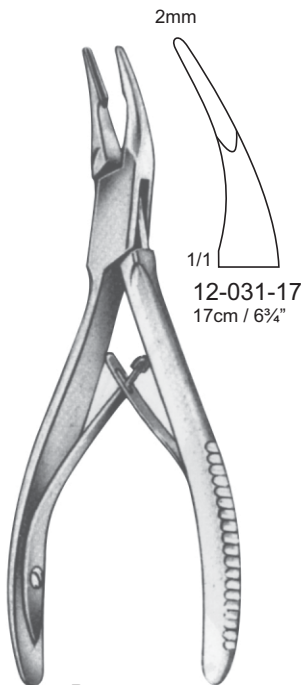

Beyer  
12-031-17

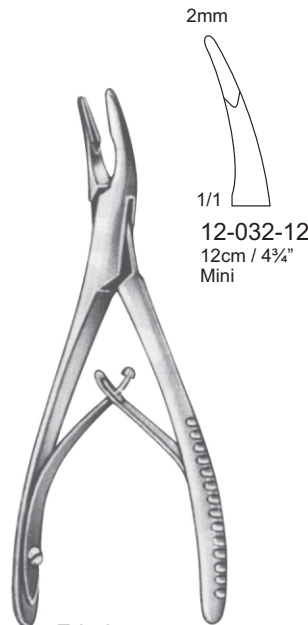

Friedman  
12-032-12 - 12-032-14

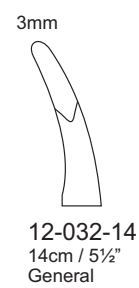



**Luer**  
12-033-01 - 12-033-03  
15cm / 6"



1/1  
12-033-01



12-033-02

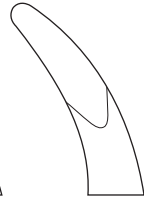

12-033-03



**Lempert**  
12-034-19  
19cm / 7½"



1/1



**Luer**  
12-035-18  
18cm / 7"

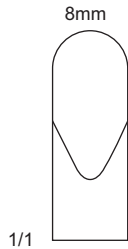

1/1

8mm

½



**Luer**  
12-036-18  
18cm / 7"

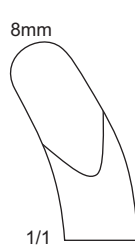

1/1

8mm

½

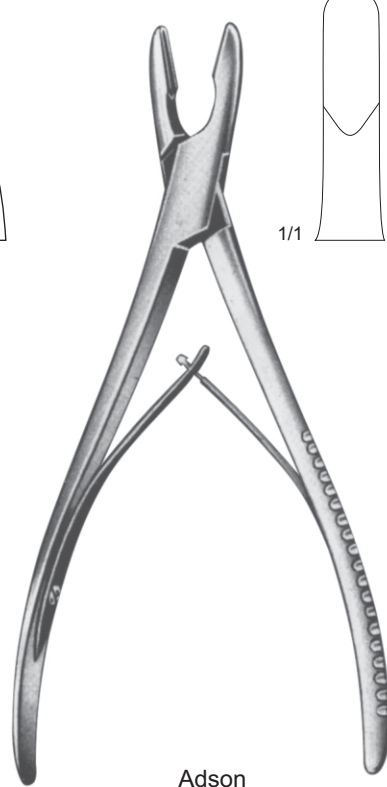

**Adson**  
12-037-20  
20cm / 8"

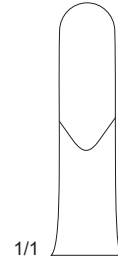

1/1

½



Ruskin Mini  
12-038-01 - 12-038-03  
15cm / 6"

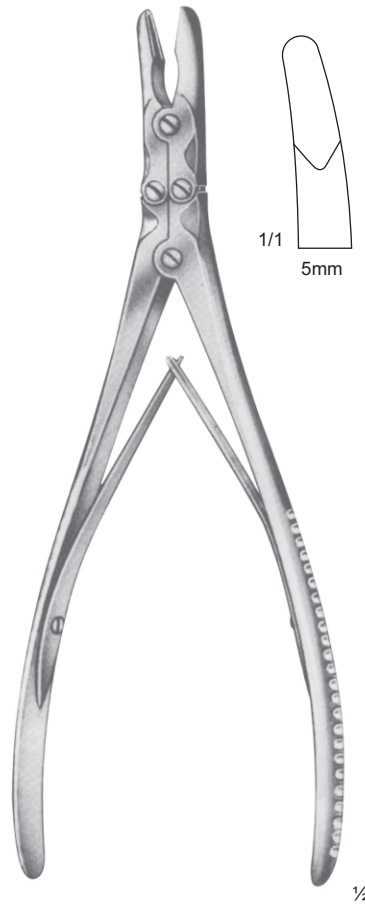

Ruskin-Ruskin  
12-039-24  
24cm / 9½"



Beyer  
12-040-18  
18cm / 7"

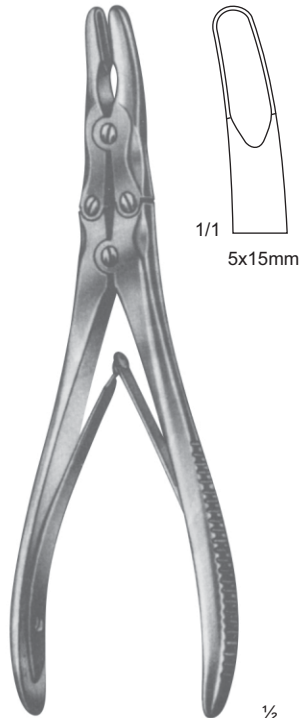

Zaufal-Jansen  
12-041-18  
18cm / 7"

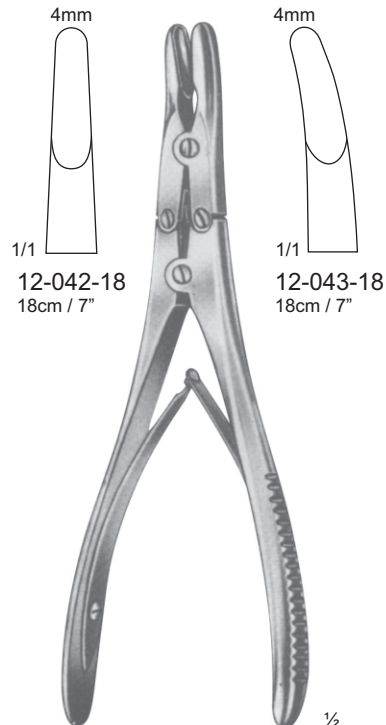

Ruskin  
12-042-18 - 12-043-18



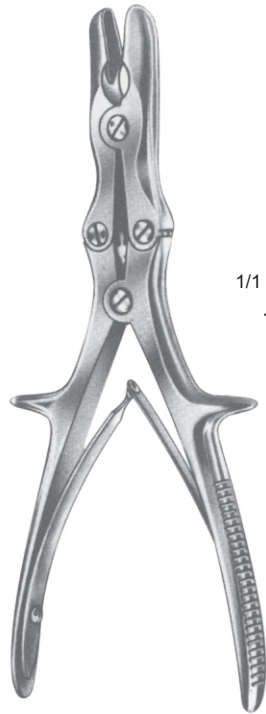

Stille  
12-044-21 - 12-045-26

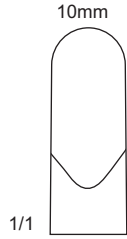

12-044-21  
21cm / 8 3/4"  
Str.



12-045-21  
21cm / 8 3/4"  
Curved.



12-044-26  
26cm / 10 1/4"  
Str.



12-045-26  
26cm / 10 1/4"  
Curved.



Stille-Luer (Duckbill)  
12-046-23  
23cm / 9"

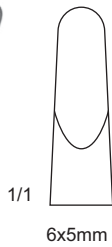

Echlin (Duckbill)  
12-047-01 - 12-047-03



12-047-01  
23cm / 9"  
2x10mm



12-047-02  
23cm / 9"  
3x10mm

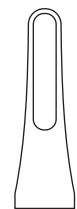

12-047-03  
23cm / 9"  
4x10mm



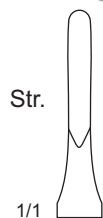

- 12-048-03 (19 cm / 7½" - 3mm bite)
- 12-049-03 (19 cm / 7½" - 4mm bite)
- 12-050-03 (24 cm / 9½" - 3mm bite)
- 12-051-03 (24 cm / 9½" - 4mm bite)

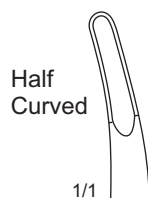

- 12-052-03 (19 cm / 7½" - 3mm bite)
- 12-053-03 (19 cm / 7½" - 4mm bite)
- 12-054-03 (24 cm / 9½" - 3mm bite)
- 12-055-03 (24 cm / 9½" - 4mm bite)

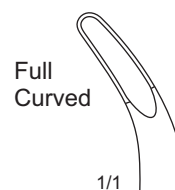

- 12-056-03 (19 cm / 7½" - 3mm bite)
- 12-057-03 (19 cm / 7½" - 4mm bite)
- 12-058-03 (24 cm / 9½" - 3mm bite)
- 12-059-03 (24 cm / 9½" - 4mm bite)



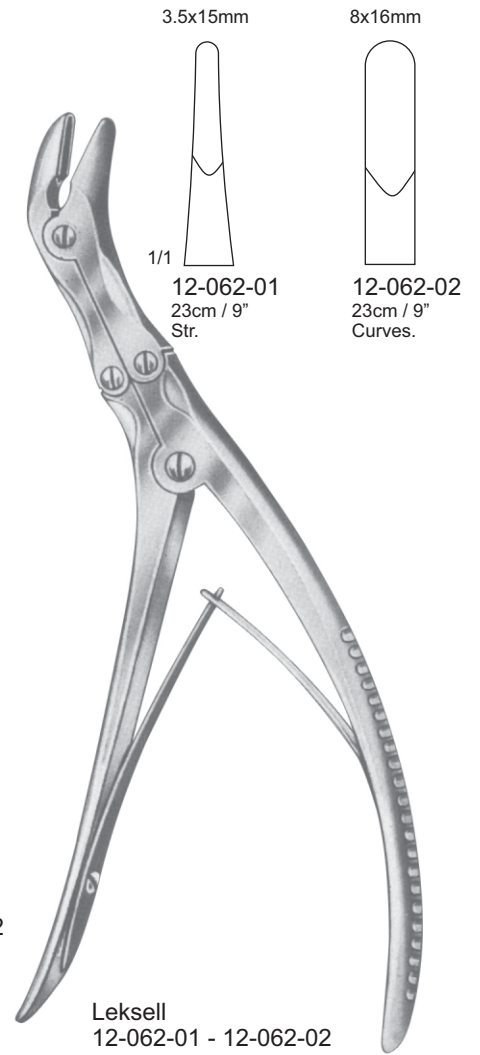

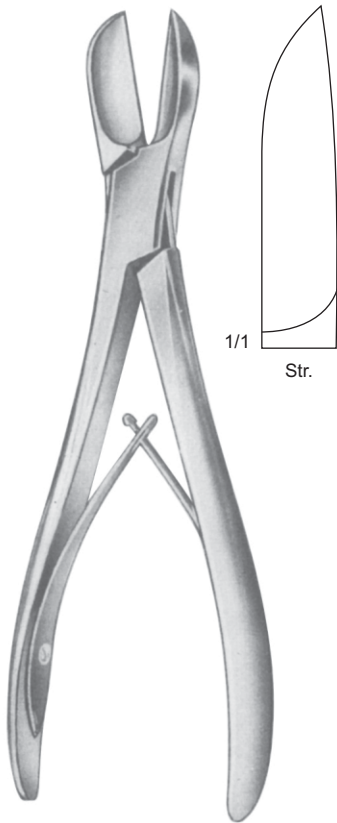

Liston  
12-063-14 14 cm / 5½"  
12-063-17 17 cm / 6¾"  
12-063-19 19 cm / 7½"  
12-063-22 22 cm / 8¾"

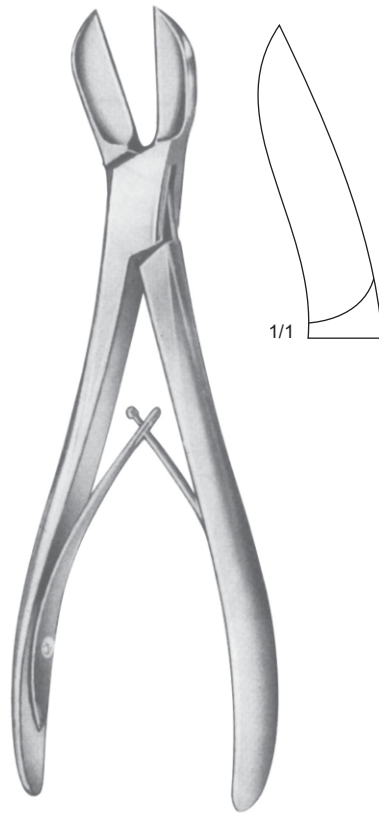

Liston  
12-064-14 14 cm / 5½"  
12-064-17 17 cm / 6¾"  
12-064-19 19 cm / 7½"  
12-064-22 22 cm / 8¾"

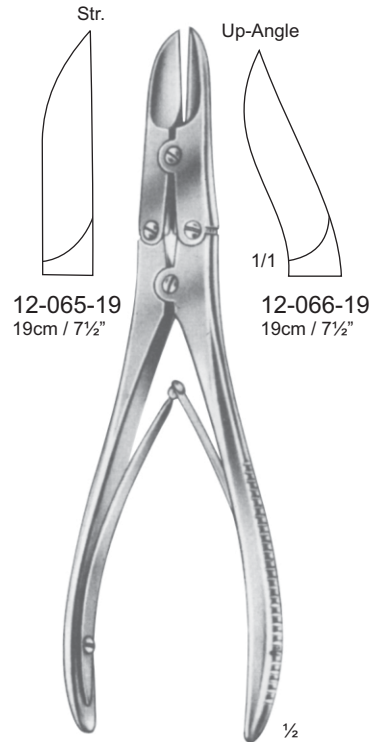

12-065-19 19cm / 7½"  
12-066-19 19cm / 7½"  
Ruskin-Liston  
12-065-19 - 12-066-19

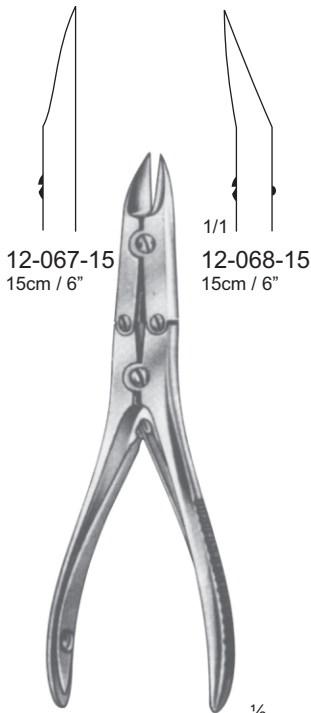

Bohler  
12-067-15 - 12-068-15



Stille-Horsley  
12-069-27  
27 cm / 10¾"

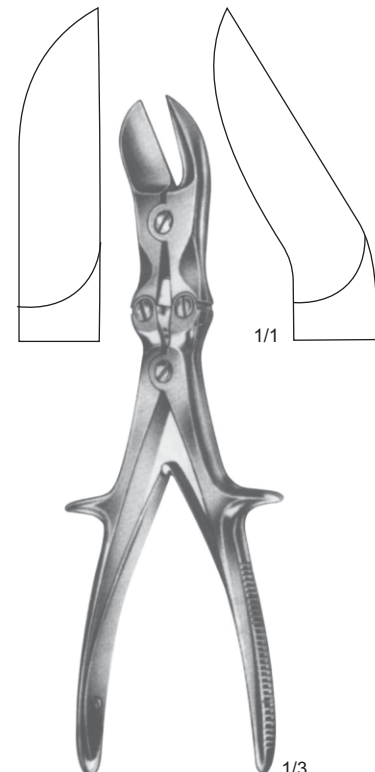

Stille-Horsley  
12-070-26  
26 cm / 10¼"



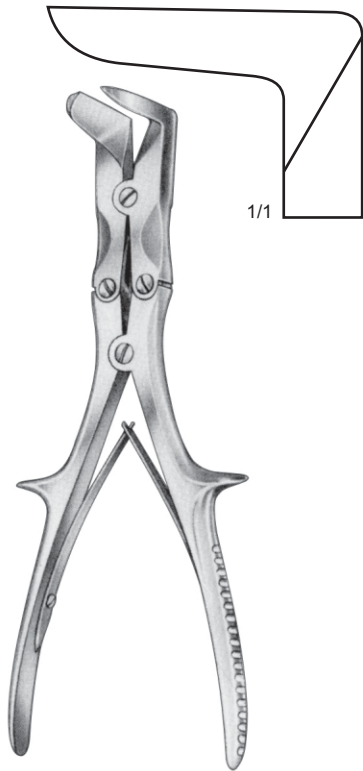

**Stille-Liston**  
12-071-26  
26cm / 10 1/4"

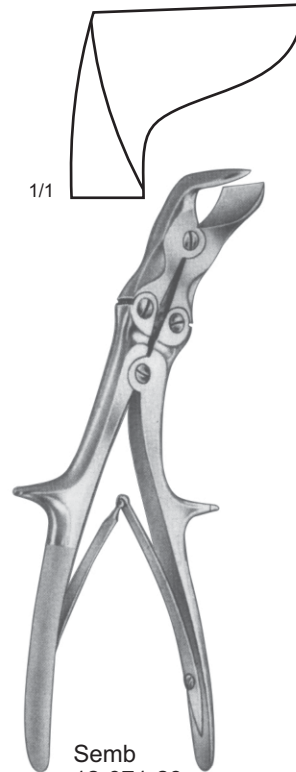

**Semb**  
12-071-23  
23cm / 9"

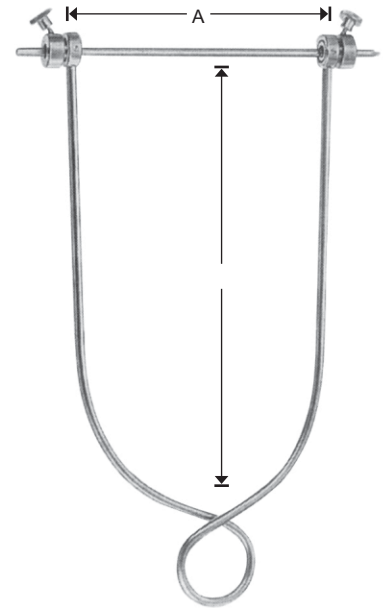

**Steinmann Traction Bow**  
12-072-01 90x90 mm  
12-072-02 110x210 mm  
12-072-03 150x210 mm  
A B

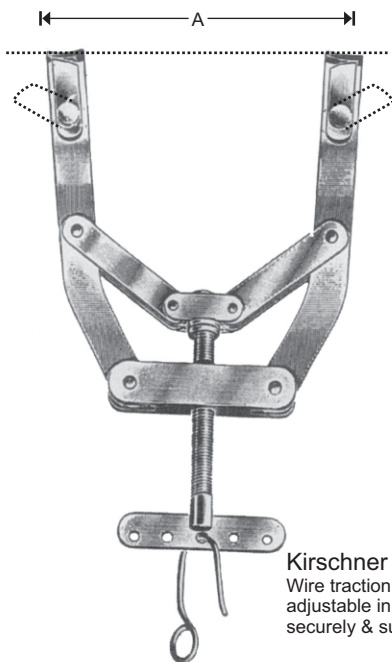

	A	B
12-073-01	max 105mm	80 ~ 95mm
12-073-02	max 160mm	90 ~ 120mm
12-073-03	max 200mm	440 ~ 170mm

**Kirschner**  
Wire traction bows, modified,  
adjustable in width, holds wire  
securely & surely, with 1 hook



**12-074-01**  
Traction hook  
Large



**12-074-02**  
Traction hook  
Small

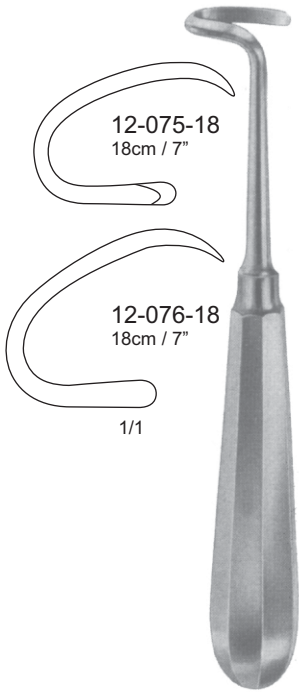

12-075-18  
18cm / 7"

12-076-18  
18cm / 7"

1/1

Doyen  
12-075-18 - 12-076-18

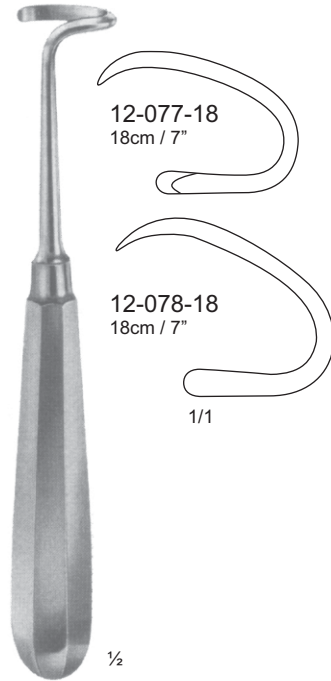

12-077-18  
18cm / 7"

12-078-18  
18cm / 7"

1/1

Doyen  
12-077-18 - 12-078-18



1/1  
12-079-23  
23cm / 9 1/2"

1/1  
12-080-23  
23cm / 9 1/2"

Doyen  
12-079-23

Doyen  
12-080-23



Bone Hooks  
12-081-20  
20cm / 8"



Bone Hooks  
12-082-22  
22cm / 8 1/2"

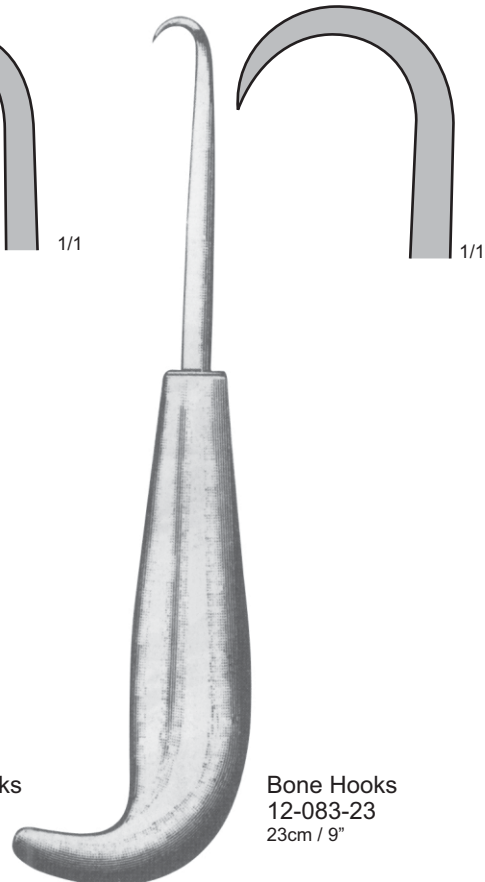

Bone Hooks  
12-083-23  
23cm / 9"





**Labsche**  
12-084-24  
24.5cm / 9 1/4"



**Cushing**  
12-085-18 18.0 cm / 7"  
12-086-20 20 cm / 8"  
12-087-20 21.0 cm / 8 1/4"



**Cushing (Square)**  
12-088-19  
19.0 cm / 7 1/2"



**Cushing (Round)**  
12-089-19  
19.0 cm / 7 1/2"

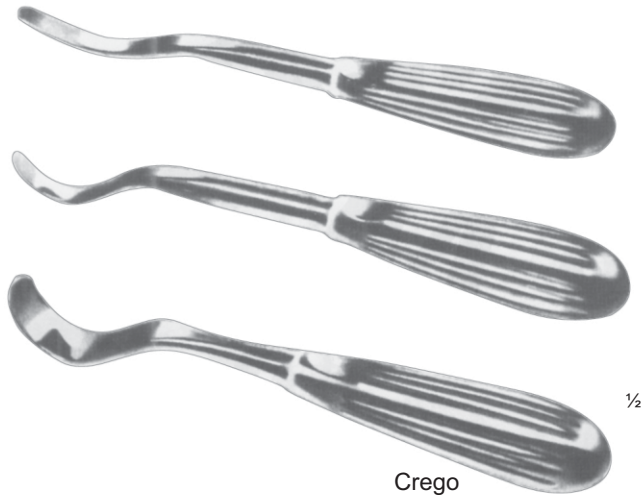

**Crego**  
12-090-01 - 12-090-03  
20 cm / 8"

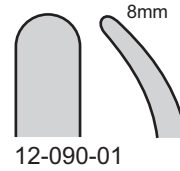

12-090-01

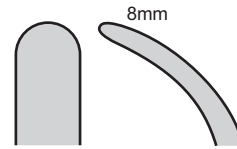

12-090-02

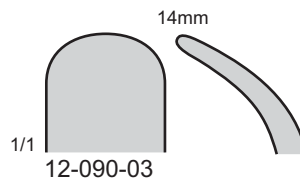

12-090-03

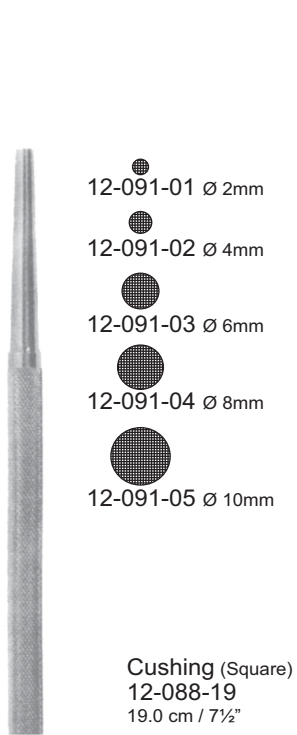

12-091-01 - 12-091-05

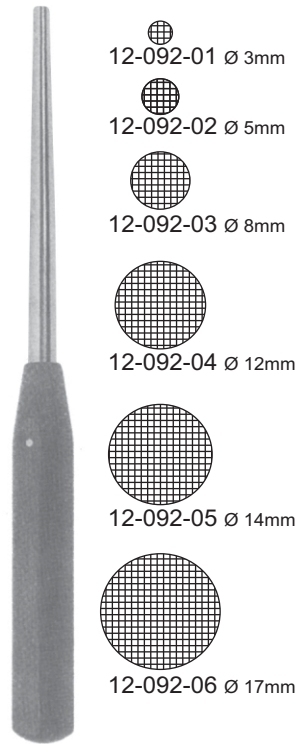

Caspar  
12-092-01 - 12-092-06  
With artificial wood handle





**Stainless Steel Handle**  
12-099-17 - 12-108-17  
17 cm / 6¾"



**Volkman (Fiber)**  
12-099-18 - 12-108-18  
17 cm / 6¾"

1/1  
Fig.01

Fig.02

Fig.03

Fig.04

Fig.05

Fig.06

Fig.07

Fig.08

Fig.09

Fig.10

**Stainless Handle**

- |                          |                           |
|--------------------------|---------------------------|
| 12-099-17 (2.8mm) Fig.01 | 12-104-17 (8.5mm) Fig.06  |
| 12-100-17 (3.6mm) Fig.02 | 12-105-17 (10.0mm) Fig.07 |
| 12-101-17 (4.4mm) Fig.03 | 12-106-17 (11.5mm) Fig.08 |
| 12-102-17 (5.2mm) Fig.04 | 12-107-17 (13.0mm) Fig.09 |
| 12-103-17 (6.8mm) Fig.05 | 12-108-17 (14.5mm) Fig.10 |

**Stainless Handle**

- |                          |                           |
|--------------------------|---------------------------|
| 12-099-18 (2.8mm) Fig.01 | 12-104-18 (8.5mm) Fig.06  |
| 12-100-18 (3.6mm) Fig.02 | 12-105-18 (10.0mm) Fig.07 |
| 12-101-18 (4.4mm) Fig.03 | 12-106-18 (11.5mm) Fig.08 |
| 12-102-18 (5.2mm) Fig.04 | 12-107-18 (13.0mm) Fig.09 |
| 12-103-18 (6.8mm) Fig.05 | 12-108-18 (14.5mm) Fig.10 |



1/1  
Fig.01

Fig.02

Fig.03

Fig.04

Fig.05

Fig.06

Fig.07

- |                          |
|--------------------------|
| 12-110-27 (2.8mm) Fig.01 |
| 12-111-27 (3.6mm) Fig.02 |
| 12-112-27 (4.4mm) Fig.03 |
| 12-113-27 (5.2mm) Fig.04 |
| 12-114-27 (6.8mm) Fig.05 |
| 12-115-27 (6.8mm) Fig.06 |
| 12-116-27 (6.8mm) Fig.07 |

**Volkman (Fiber Handle)**  
12-110-27 - 12-116-27  
27 cm / 10½"





**Cobb Fiber Handle**  
12-117-25 - 12-123-35

- 12-117-25 25cm 10" (10mm)
- 12-118-25 25cm 10" (13mm)
- 12-119-25 25cm 10" (19mm)
- 12-120-25 25cm 10" (25mm)
- 12-121-35 35cm 13¾" (10mm)
- 12-122-35 35cm 13¾" (13mm)
- 12-123-35 35cm 13¾" (19mm)

**Cobb Stainless Steel Handle**  
12-124-25 - 12-130-35

- 12-124-25 25cm 10" (10mm)
- 12-125-25 25cm 10" (13mm)
- 12-126-25 25cm 10" (19mm)
- 12-127-25 25cm 10" (25mm)
- 12-128-35 35cm 13¾" (10mm)
- 12-129-35 35cm 13¾" (13mm)
- 12-130-35 35cm 13¾" (19mm)



Smith-Peterson  
12-131-20 - 12-137-20

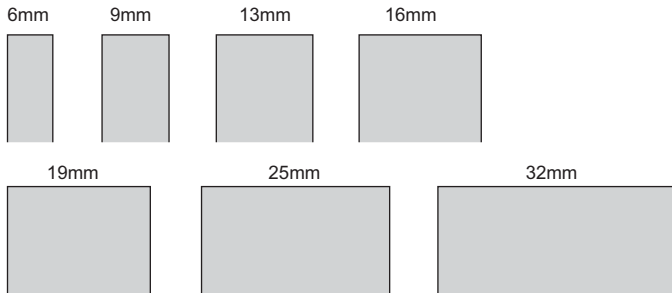

Fiber handle  
Please add the symbol "FH" to the Catalog Numbers

- 12-131-25 20cm / 8" (06mm) Straight
- 12-132-25 20cm / 8" (09mm) Straight
- 12-133-25 20cm / 8" (13mm) Straight
- 12-134-25 20cm / 8" (16mm) Straight
- 12-135-35 20cm / 8" (19mm) Straight
- 12-136-35 20cm / 8" (25mm) Straight
- 12-137-35 20cm / 8" (32mm) Straight



Smith-Peterson  
12-138-20 - 12-144-20

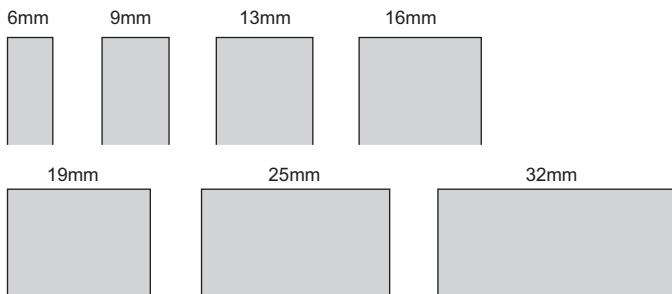

Fiber handle  
Please add the symbol "FH" to the Catalog Numbers

- 12-138-25 20cm / 8" (06mm) Curved
- 12-139-25 20cm / 8" (09mm) Curved
- 12-140-25 20cm / 8" (13mm) Curved
- 12-141-25 20cm / 8" (16mm) Curved
- 12-142-35 20cm / 8" (19mm) Curved
- 12-143-35 20cm / 8" (25mm) Curved
- 12-144-35 20cm / 8" (32mm) Curved



Smith-Peterson  
12-145-20 - 12-151-20

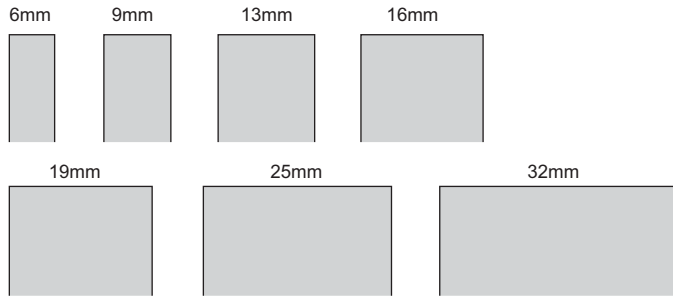

Fiber handle  
Please add the symbol "FH" to the  
Catalog Numers

- 12-145-20 20cm / 8" (06mm) Straight
- 12-146-20 20cm / 8" (09mm) Straight
- 12-147-20 20cm / 8" (13mm) Straight
- 12-148-20 20cm / 8" (16mm) Straight
- 12-149-20 20cm / 8" (19mm) Straight
- 12-150-20 20cm / 8" (25mm) Straight
- 12-151-20 20cm / 8" (32mm) Straight



Smith-Peterson  
12-152-20 - 12-158-20

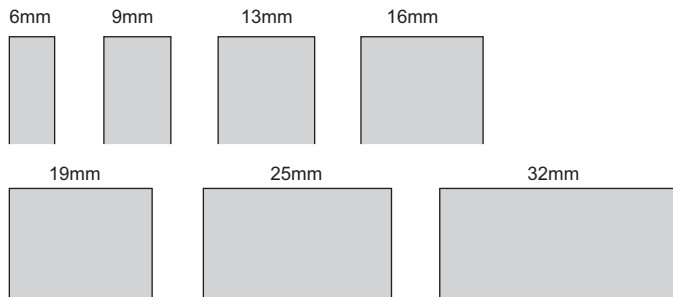

Fiber handle  
Please add the symbol "FH" to the  
Catalog Numers

- 12-152-20 20cm / 8" (06mm) Curved
- 12-153-20 20cm / 8" (09mm) Curved
- 12-154-20 20cm / 8" (13mm) Curved
- 12-155-20 20cm / 8" (16mm) Curved
- 12-156-20 20cm / 8" (19mm) Curved
- 12-157-20 20cm / 8" (25mm) Curved
- 12-158-20 20cm / 8" (32mm) Curved





- 12-159-14 14cm / 5½" (4mm)
- 12-160-14 14cm / 5½" (6mm)
- 12-161-14 14cm / 5½" (8mm)
- 12-162-14 14cm / 5½" (10mm)
- 12-163-14 14cm / 5½" (12mm)

**Chisels**  
12-159-14 - 12-163-14

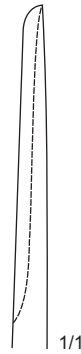

- 12-164-14 14cm / 5½" (04mm)
- 12-165-14 14cm / 5½" (06mm)
- 12-166-14 14cm / 5½" (08mm)
- 12-167-14 14cm / 5½" (10mm)
- 12-168-14 14cm / 5½" (12mm)

**Gouges**  
12-164-14 - 12-168-14

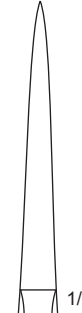

- 12-169-14 14cm / 5½" (04mm)
- 12-170-14 14cm / 5½" (06mm)
- 12-171-14 14cm / 5½" (08mm)
- 12-172-14 14cm / 5½" (10mm)
- 12-173-14 14cm / 5½" (12mm)

**Osteotomes**  
12-169-14 - 12-173-14



- 12-174-14 14cm / 5½" (03mm)
- 12-175-14 14cm / 5½" (04mm)
- 12-176-14 14cm / 5½" (05mm)
- 12-177-14 14cm / 5½" (06mm)

**Partsch-Chisels**  
12-174-14 - 12-177-14

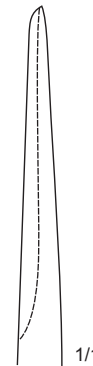

- 12-178-14 14cm / 5½" (03mm)
- 12-179-14 14cm / 5½" (04mm)
- 12-180-14 14cm / 5½" (05mm)
- 12-181-14 14cm / 5½" (06mm)

**Partsch-Chisels**  
12-178-14 - 12-181-14



- 12-182-24 24.5 cm / 9 3/4" (04mm)
- 12-183-24 24.5 cm / 9 3/4" (08mm)
- 12-184-24 24.5 cm / 9 3/4" (10mm)
- 12-185-24 24.5 cm / 9 3/4" (13mm)
- 12-186-24 24.5 cm / 9 3/4" (15mm)
- 12-187-24 24.5 cm / 9 3/4" (18mm)
- 12-188-24 24.5 cm / 9 3/4" (20mm)
- 12-189-24 24.5 cm / 9 3/4" (25mm)
- 12-190-24 24.5 cm / 9 3/4" (30mm)
- 12-191-24 24.5 cm / 9 3/4" (38mm)
- 12-192-24 24.5 cm / 9 3/4" (44mm)
- 12-193-24 24.5 cm / 9 3/4" (50mm)

Lambotte Osteotomes, Straight  
12-182-24 - 12-193-44

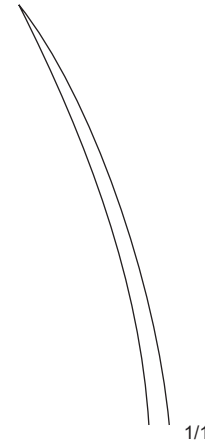

- 12-194-24 24.5 cm / 9 3/4" (08mm)
- 12-195-24 24.5 cm / 9 3/4" (13mm)
- 12-196-24 24.5 cm / 9 3/4" (18mm)
- 12-197-24 24.5 cm / 9 3/4" (25mm)
- 12-198-24 24.5 cm / 9 3/4" (30mm)
- 12-199-24 24.5 cm / 9 3/4" (38mm)

Lambotte Osteotomes, Curved  
12-194-24 - 12-199-24

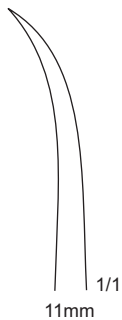

Obwegeser Osteotomes, Curved  
12-200-24  
24.5 cm / 9 3/4"



Niederdellmann Osteotomes, Curved  
12-201-01 24.5 cm / 9 3/4" 8mm  
12-201-02 24.5 cm / 9 3/4" 11mm



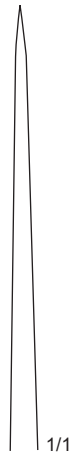

- 12-205-08 (08mm)
- 12-205-10 (10mm)
- 12-205-12 (12mm)
- 12-205-15 (15mm)
- 12-205-20 (20mm)

**Osteotomes Straight (Fiber Handle)**  
12-205-08 - 12-205-20  
23 cm / 9"

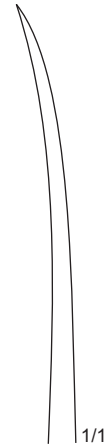

- 12-206-08 (08mm)
- 12-206-10 (10mm)
- 12-206-12 (12mm)
- 12-206-15 (15mm)
- 12-206-20 (20mm)

**Osteotomes Curved (Fiber Handle)**  
12-206-08 - 12-206-20  
23 cm / 9"



- 12-211-04 (04mm)
- 12-211-06 (06mm)
- 12-211-08 (08mm)
- 12-211-10 (10mm)
- 12-211-12 (12mm)

**Mini-Lexer Osteotomes (Fiber Handle)**  
12-211-04 - 12-211-12

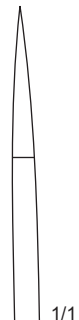

- 12-212-04 (04mm)
- 12-212-07 (07mm)
- 12-212-10 (10mm)
- 12-212-15 (15mm)
- 12-212-20 (20mm)
- 12-212-25 (25mm)
- 12-212-30 (30mm)

**Lexer Osteotomes (Fiber Handle)**  
12-212-04 - 12-212-30  
23 cm / 9"

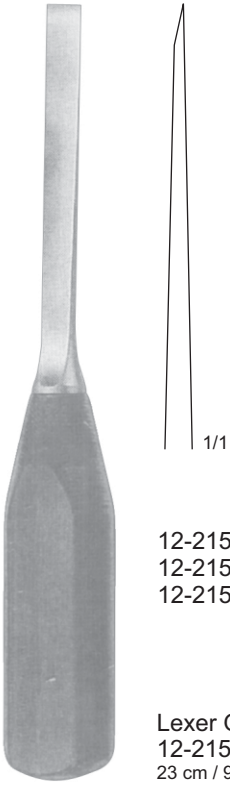

- 12-215-10 (10mm)
- 12-215-15 (15mm)
- 12-215-20 (20mm)

**Lexer Osteotomes (Fiber Handle)**  
12-215-10 - 12-215-20  
23 cm / 9"



- 12-220-04 (04mm)
- 12-220-16 (06mm)
- 12-220-18 (08mm)
- 12-220-10 (10mm)
- 12-220-12 (12mm)

**Mini-Lexer Gouges (Fiber Handle)**  
12-220-04 - 12-220-12  
18 cm / 7"

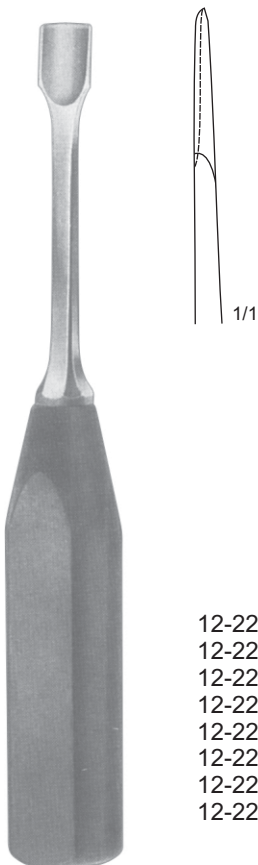

- 12-225-04 (04mm)
- 12-225-08 (08mm)
- 12-225-10 (10mm)
- 12-225-12 (12mm)
- 12-225-15 (15mm)
- 12-225-20 (20mm)
- 12-225-25 (25mm)
- 12-225-30 (30mm)

**Gouge for (Fiber Handle)**  
12-225-04 - 12-225-12  
23 cm / 9"

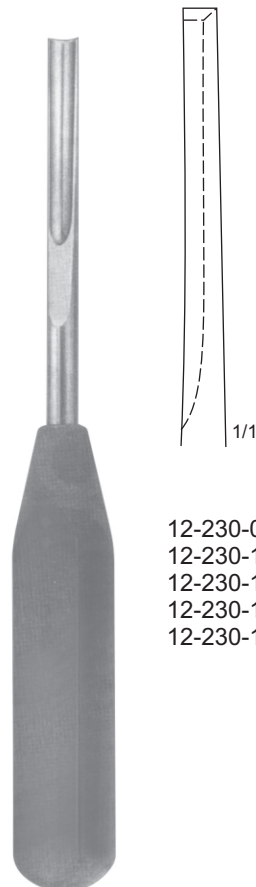

- 12-230-04 (04mm)
- 12-230-16 (06mm)
- 12-230-18 (08mm)
- 12-230-10 (10mm)
- 12-230-12 (12mm)

**Gouge for removing broken screw (Fiber Handle)**  
12-230-04 - 12-230-12  
23 cm / 9"





2.5mm



3.5mm



1/2

Screw Driver  
With Fibre handle  
12-233-25  
25 cm / 10"



1/2

Screw Driver  
With Fibre handle  
12-234-25  
25 cm / 10"



1/2

Screw Driver  
With Fibre handle  
12-235-25  
25 cm / 10"





Hudson

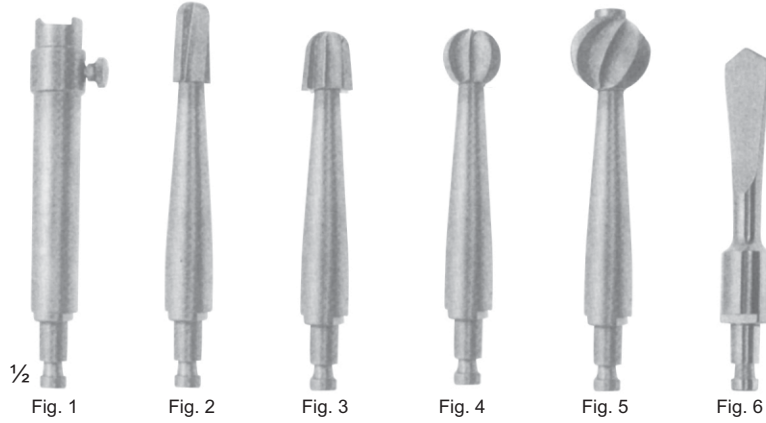

12-236-00 Set

- 12-236-01 1 Hand bone drill Fig.1
- 12-236-02 1 Extension Piece Fig.1
- 12-236-03 1 Burr Ø 10mm Fig.2
- 12-236-04 1 Burr Ø 14mm Fig.3
- 12-236-05 1 Burr Ø 16mm Fig.4
- 12-236-06 1 Burr Ø 22mm Fig.5
- 12-236-07 1 Burr Ø 13mm Fig.6

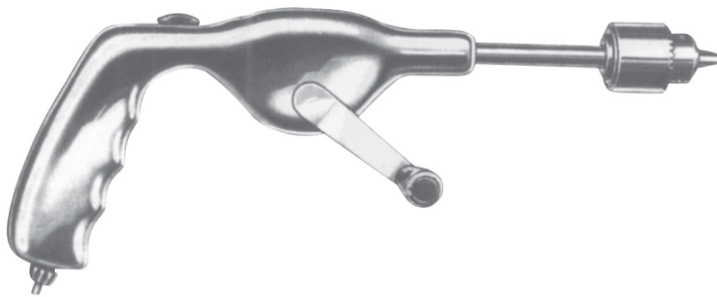

12-237-00  
28 cm / 11"



1/2  
Cock Screw  
12-238-18  
18 cm / 7"

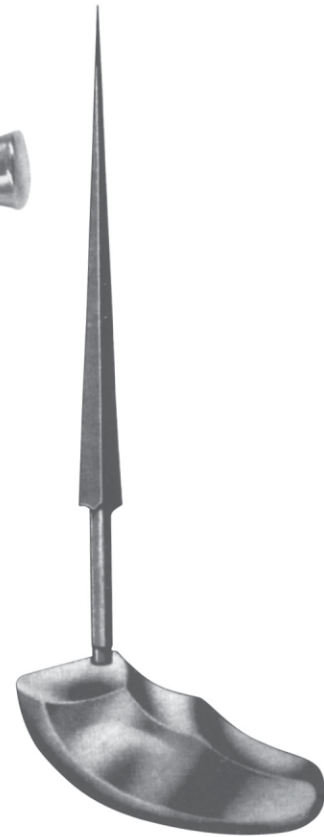

Parthes  
12-239-22  
22 cm / 8 3/4"





140 gm



Mellet, Removable Discs  
12-240-25  
25cm / 7 7/8"

185 gm



Mellet, Removable Discs  
12-241-20  
20cm / 8"

240 gm



Cottle  
12-242-18  
18.5cm / 7 3/8"

165 gm



Medro Mallet  
12-243-19  
19cm / 7 1/2"

120 gm



1/2  
Medro Mallet  
12-244-16  
16.5cm / 6 1/2"

140 gm



Hajek  
12-245-21  
21.5cm / 8 1/2"

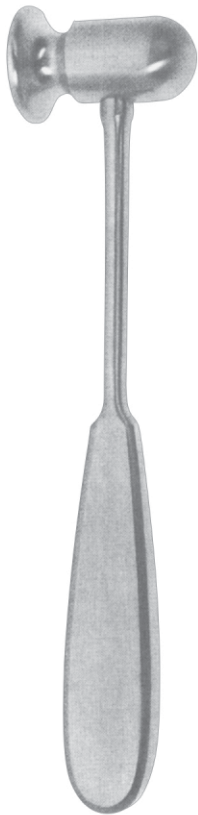

½

**Doyen**

- 12-246-25 25cm / 10" (120 gm)
- 12-247-30 30cm / 12" (120 gm)
- 12-248-35 35cm / 13¼" (120 gm)



½

**Medro Mallet (Fiber Handle)**

- 12-249-30 30 cm / 12" (450 gm)
- 12-250-35 50 cm / 19¼" (900 gm)



**Medro Mallet (Plastic Disc)**

- 12-251-25 18 cm / 7" (140 gm)



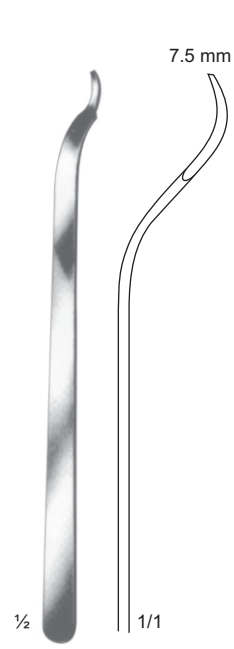

**12-252-15**  
15cm / 6"

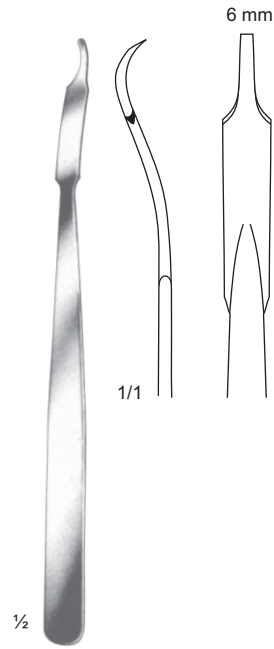

**Mini-Howman**  
12-253-16  
16.5cm / 6½"

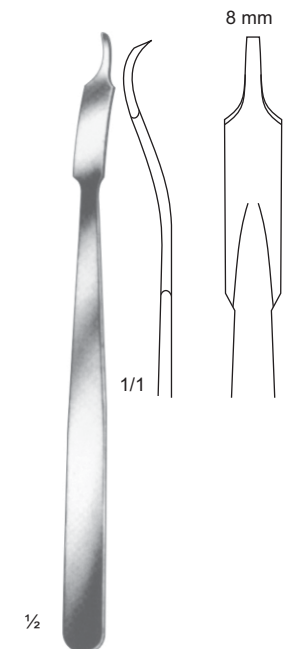

**Mini-Howman**  
12-254-16  
16.5cm / 6½"



**Howman**  
12-255-21  
21cm / 8.5"



**Howman**  
12-256-24  
24cm / 9.5"



**Howman**  
12-257-24  
24cm / 9.5"

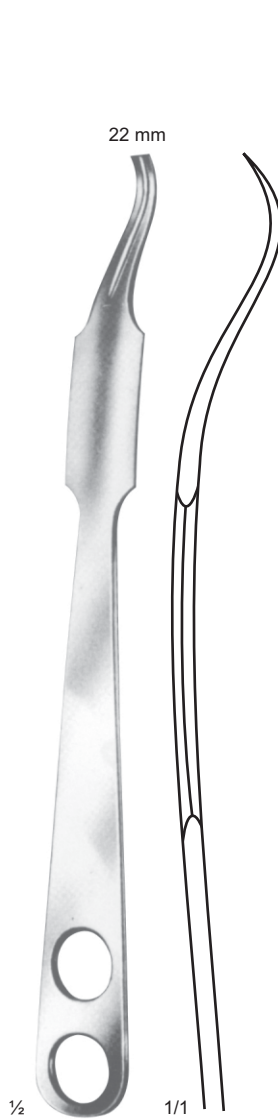

Howman  
12-258-24  
24cm / 9.5"



Howman  
12-258-28  
28cm / 11"

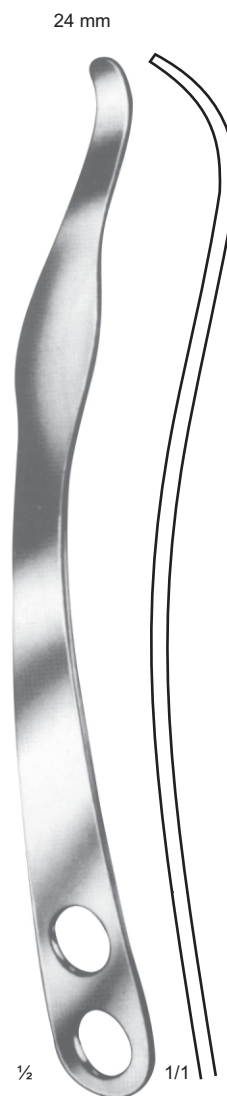

Howman  
12-258-27  
27cm / 10½"





**Lange-Howman**  
12-259-26  
26cm / 10½"



**Howman**  
12-260-28  
28cm / 11"

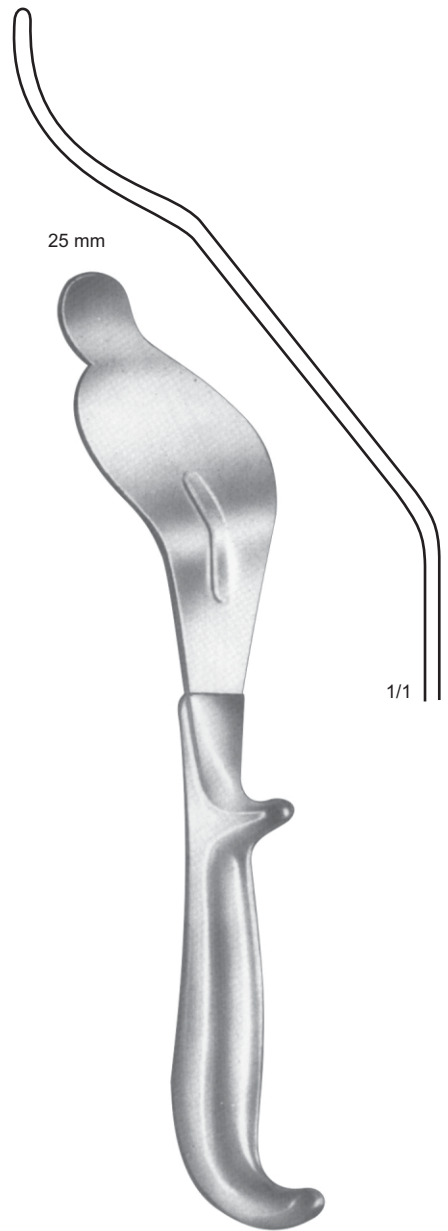

**Bennet**  
12-261-45 (45mm)  
12-261-60 (60mm)  
25cm / 10"



1/2

Langenbeck  
12-262-23  
23cm / 9"



1/2

Langenbeck  
12-263-23  
23cm / 9"



1/2

Bruns  
12-264-21  
21cm / 8 1/4"



1/3

Bruns  
12-265-20  
20cm / 8"





Putti  
12-266-24  
24cm / 9½"

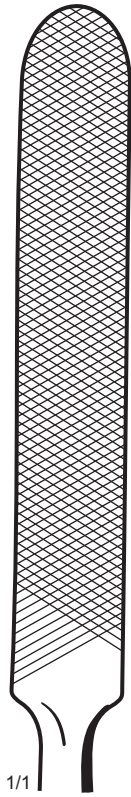

Putti  
12-267-30  
30cm / 12"

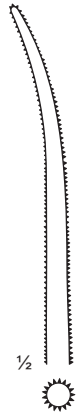

Putti  
12-268-27  
27cm / 10½"

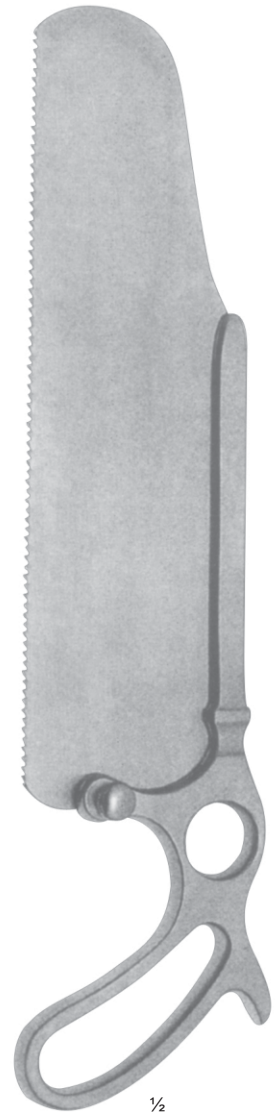

Scatteriee Saw  
12-269-29  
29cm / 11½"



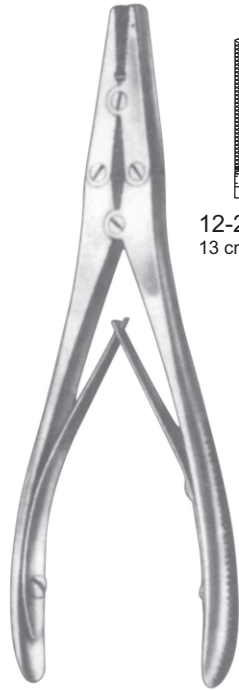

12-270-01 12-270-02  
13 cm / 5½" 18 cm / 7"

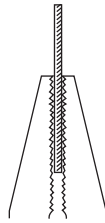
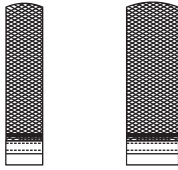

Parallel Action

12-270-01 - 12-270-02  
18cm / 7"



12-271-13  
13 cm / 5½"



12-271-18  
18 cm / 7"

12-271-13 - 12-271-08  
18cm / 7"

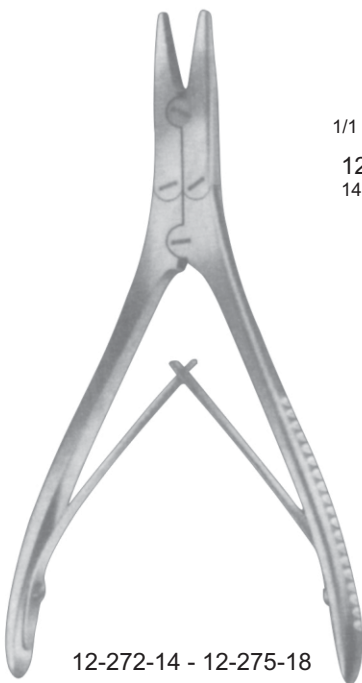

12-272-14 - 12-275-18



1/1  
12-272-14  
14.5 cm / 5¾"



12-273-18  
18 cm / 7"



12-274-18  
18 cm / 7"



12-275-18  
18 cm / 7"



1/1



12-278-17  
17 cm / 6¾"





12-279-16  
16 cm / 6¼"



12-280-16  
16 cm / 6¼"



12-281-14  
14.5 cm / 5¾"

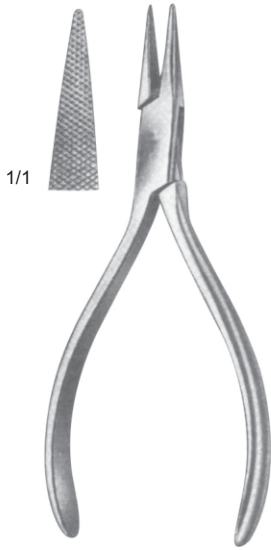

1/1

12-283-14  
14 cm / 5½"

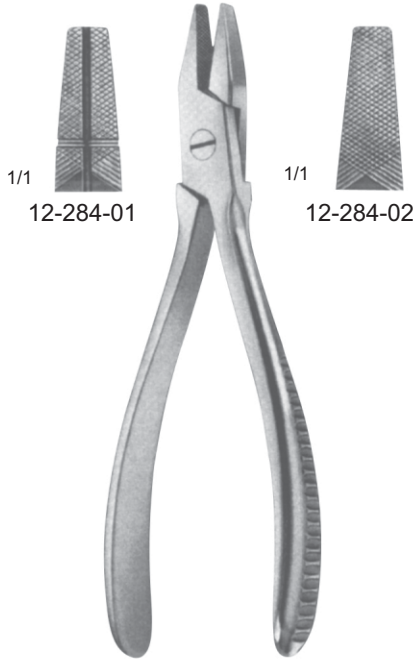

1/1

12-284-01

1/1

12-284-02

12-284-01 - 12-284-02  
17 cm / 6¾"



1/1

12-285-19  
19 cm / 7½"

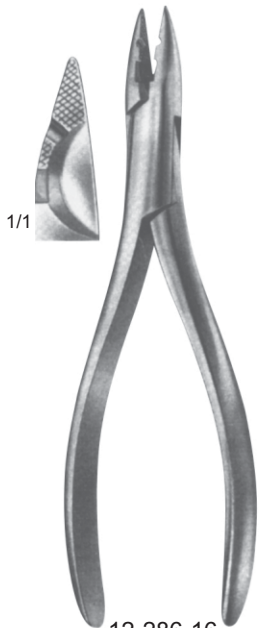

1/1

12-286-16  
16 cm / 6¼"

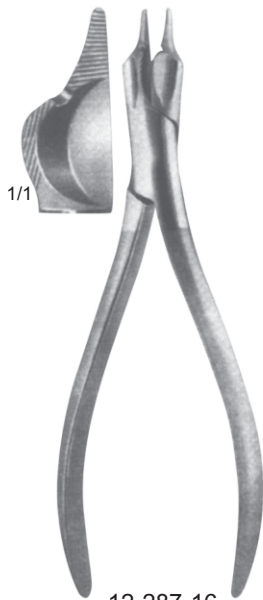

1/1

12-287-16  
16 cm / 6¼"



12-288-17  
17 cm / 6¾"

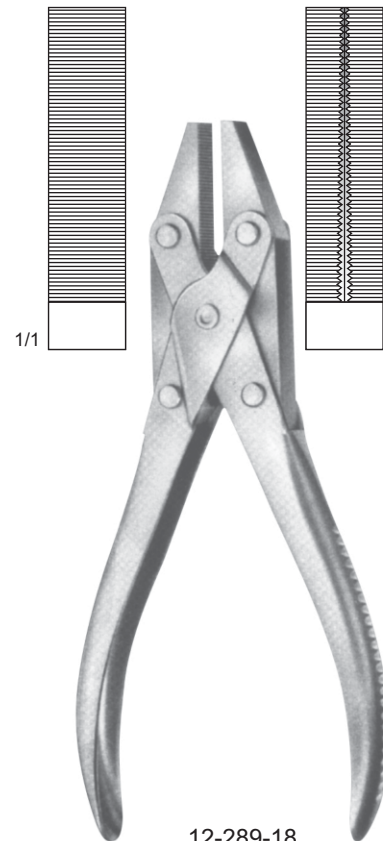

1/1

12-289-18  
18 cm / 7¼"



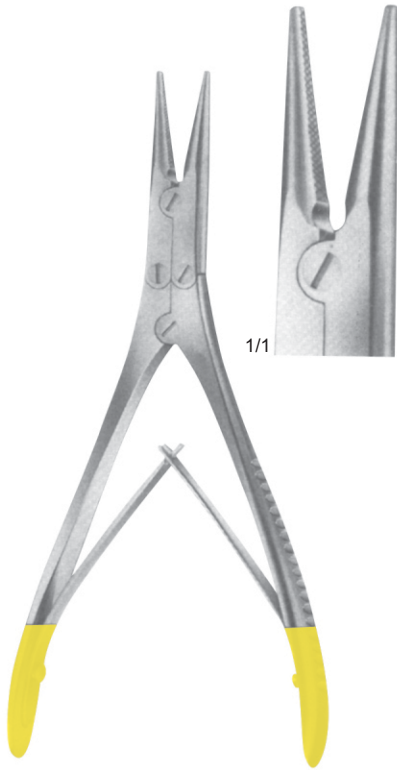

12-290-14 - 12-292-18  
18 cm / 7"

1/1



12-290-14  
14.5 cm / 5 3/4"



12-291-18  
18 cm / 7"



12-292-18  
18 cm / 7"



Kirschner TC  
12-293-47  
47 cm / 18 1/2"



Wire Cutter TC  
12-294-18  
18.5 cm / 7"



Wire Cutter TC  
12-295-22  
22 cm / 8 1/2"

1/1





**Hercules TC**  
12-296-47 47 cm / 18½"  
12-297-54 54 cm / 21¼"



**Reill TC**  
12-298-17  
17.5 cm / 7"

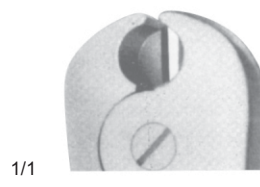

**End Cutter TC**  
12-299-18  
18 cm / 7"



**Wire Cutter TC**  
12-300-23  
23.5 cm / 9¼"

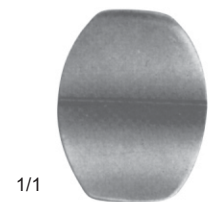

**Mini Wire Cutter TC**  
12-301-14  
14 cm / 5¼"





12-302-01

Bending Irons  
12-302-01 - 12-302-02



12-302-02



Bending Irons  
12-303-16  
16 cm / 6¼"



Jewett  
12-304-20  
20 cm / 8"

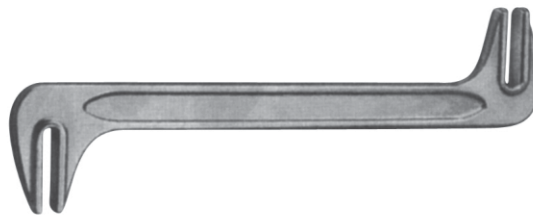

Plate bender  
12-305-25  
25 cm / 10"



[www.krnano.com](http://www.krnano.com)

산부인과

GYNECOLOGICAL &  
OBSTETRICAL INSTRUMENTS

Page 238 - 253



**Cusco**  
13-001-01 (Small)  
13-001-02 (Medium)  
13-001-03 (Large)

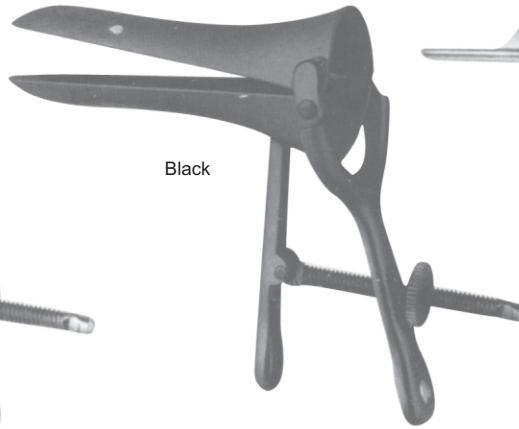

Black

**Cusco Black**  
13-002-01 (Small)  
13-002-02 (Medium)  
13-002-03 (Large)

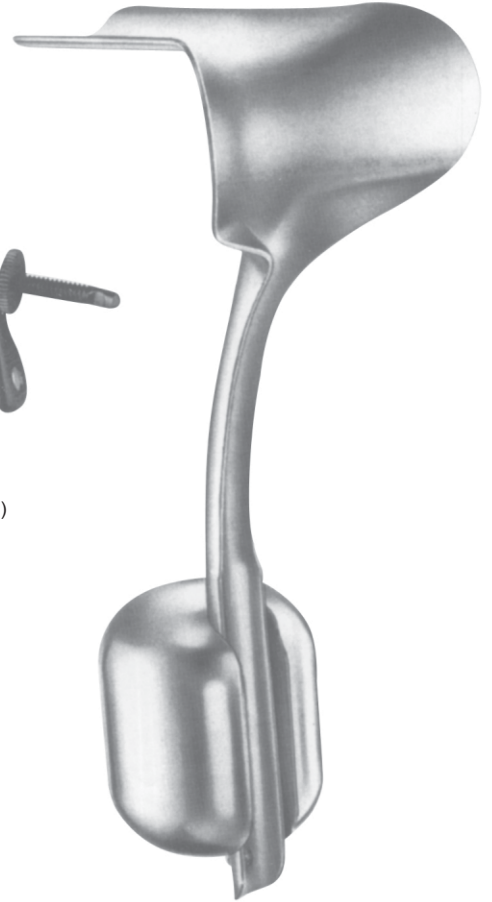

**Auvar**  
13-003-01 75x42~40  
13-003-02 105x43~40  
23 cm / 9"  
With Detachable weight



**Cusco Special**  
13-004-01 (Small)  
13-004-02 (Medium)  
13-004-03 (Large)



Black

**Cusco Special Black**  
13-005-01 (Small)  
13-005-02 (Medium)  
13-005-03 (Large)



**Sakurai's**  
13-006-00



**Sakurai's Black**  
13-007-00



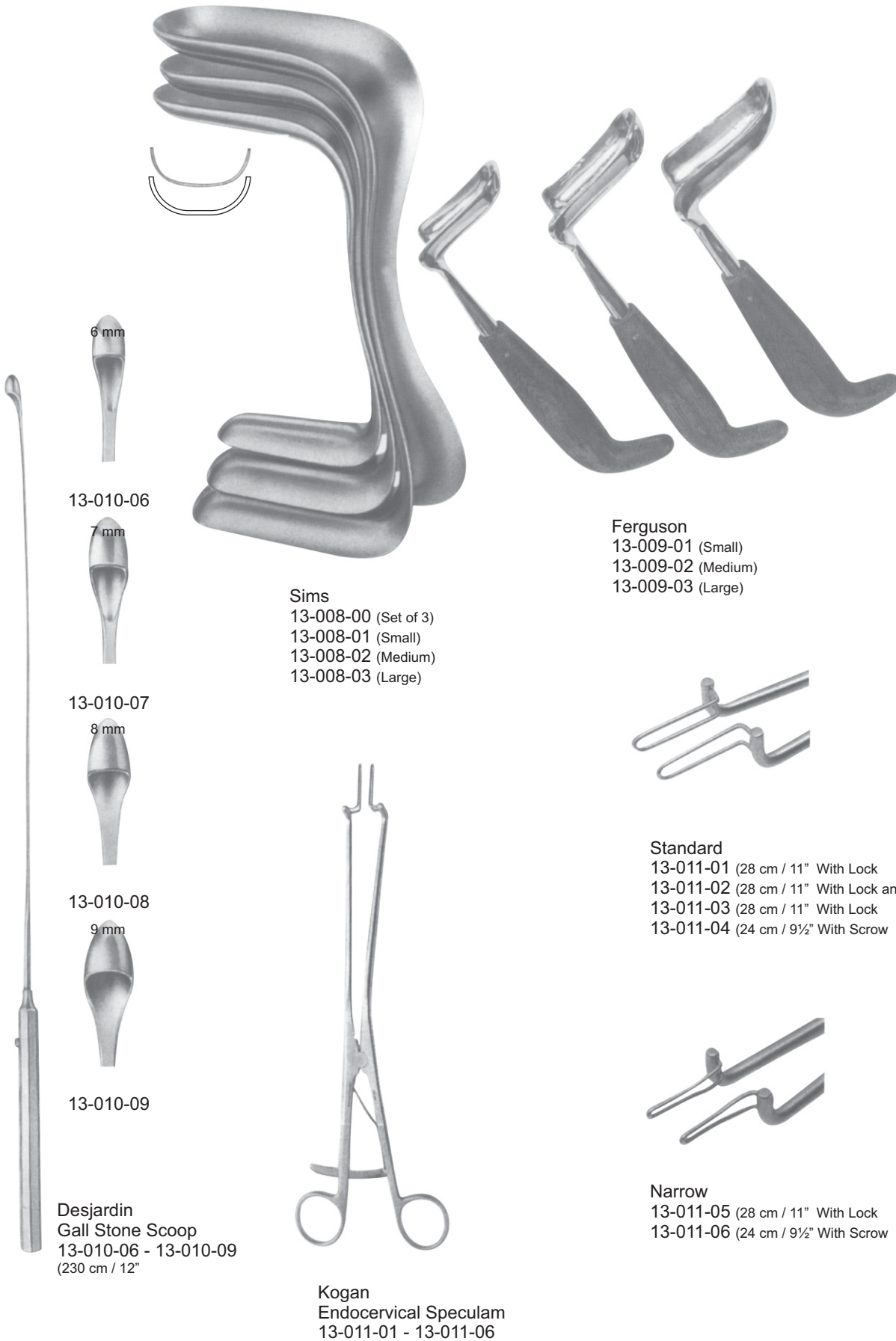

6 mm  
13-010-06

7 mm  
13-010-07

8 mm  
13-010-08

9 mm  
13-010-09

Desjardin  
Gall Stone Scoop  
13-010-06 - 13-010-09  
(230 cm / 12")

Sims  
13-008-00 (Set of 3)  
13-008-01 (Small)  
13-008-02 (Medium)  
13-008-03 (Large)



Kogan  
Endocervical Speculum  
13-011-01 - 13-011-06

Ferguson  
13-009-01 (Small)  
13-009-02 (Medium)  
13-009-03 (Large)



Standard  
13-011-01 (28 cm / 11" With Lock)  
13-011-02 (28 cm / 11" With Lock angled shaft)  
13-011-03 (28 cm / 11" With Lock)  
13-011-04 (24 cm / 9½" With Screw)



Narrow  
13-011-05 (28 cm / 11" With Lock)  
13-011-06 (24 cm / 9½" With Screw)





Ø 4 mm

Malleable

1/2

Sims  
13-012-34  
34 cm 13 1/4"

Ø 5 mm

Malleable

1/2

Mayo  
13-013-33  
33 cm 13"

Ø 25 mm

Malleable

1/2

Sims (Special)  
13-014-31  
31 cm 12 1/4"



- |               |               |
|---------------|---------------|
| 13-015-01 #1  | 13-016-11 #11 |
| 13-015-02 #2  | 13-016-12 #12 |
| 13-015-03 #3  | 13-015-13 #13 |
| 13-016-04 #4  | 13-016-14 #14 |
| 13-015-05 #5  | 13-015-15 #15 |
| 13-015-06 #6  | 13-016-16 #16 |
| 13-015-07 #7  | 13-017-17 #17 |
| 13-015-08 #8  | 13-018-18 #18 |
| 13-015-09 #9  | 13-015-19 #19 |
| 13-015-10 #10 | 13-015-20 #20 |

Hegar  
13-015-00 #1~13 Set  
13-016-00 #1~11 Set



1/2

Hegar (Double Ended)

- 13-017-00 (Set of 9)
- 13-017-01 1+2 mm
- 13-017-02 3+4 mm
- 13-017-03 5+6 mm
- 13-017-04 7+8 mm
- 13-017-05 9+10 mm
- 13-017-06 11+12 mm
- 13-017-07 13-14 mm
- 13-017-08 15+16 mm
- 13-017-09 5+6 mm



1/2

Hegar (Double Ended)

- 13-018-00 (Set of 6)
- 13-018-01 4.5 / 5 mm
- 13-018-02 5.5 / 6 mm mm
- 13-018-03 6.5 / 9 mm
- 13-018-04 7.5 / 84 mm
- 13-018-05 8.5 / 9 mm
- 13-018-06 9.5 / 10 mm

1/2





Kevorkian  
13-019-01 - 13-019-09

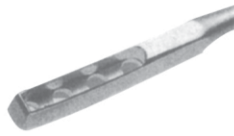

1/1

Kevorkian  
13-019-01 (Rigid)  
13-019-02 (Malleable)  
13-019-03 (Minihead)  
30 cm / 11¾"



1/1

Mini Kevorkian  
13-019-04 (Rigid)  
13-019-05 (Malleable)  
30 cm / 11¾"



1/1

Duncan  
13-019-06 (with Basket)  
13-019-07 (without Basket)  
30 cm / 11¾"



1/1

Duncan  
13-019-08 (with Basket)  
13-019-09 (without Basket)  
24 cm / 9½"



Malleable



Malleable

(6 mm)



# 0

13-020-00  
13-021-00

(7 mm)



# 1

13-020-01  
13-021-01

(8 mm)



# 2

13-020-02  
13-021-02

(10 mm)



# 3

13-020-03  
13-021-03

(12 mm)



# 4

13-020-04  
13-021-04

(13 mm)



# 5

13-020-05  
13-021-05

(14 mm)



# 6

13-020-06  
13-021-06

(15 mm)



# 7

13-020-07  
13-021-07

(16.5 mm)



# 8

13-020-08  
13-021-08

(17.5 mm)



# 9

13-020-09  
13-021-09

(20 mm)



# 10

13-020-10  
13-021-10

Sims Sharp  
13-020-00 - 13-020-10  
31 cm / 12½"

Sims Blunt  
13-021-00 - 13-021-10  
31 cm / 12½"





1/2

- Sims**  
28 cm / 11"
- 13-022-00 05.5 mm # 0
  - 13-022-01 07.5 mm # 1
  - 13-022-02 08.5 mm # 2
  - 13-022-03 10.5 mm # 3
  - 13-022-04 11.5 mm # 4
  - 13-022-05 13.5 mm # 5
  - 13-022-06 17.0 mm # 6
  - 13-022-07 20.0 mm # 7
  - 13-022-08 24.0 mm # 8
  - 13-022-09 28.0 mm # 9



1/2

- J.O.M.W.**  
28 cm / 11"
- 13-023-01 04.5 mm # 1
  - 13-023-02 06.5 mm # 2
  - 13-023-03 07.5 mm # 3
  - 13-023-04 09.9 mm # 4
  - 13-023-05 12.0 mm # 5
  - 13-023-06 15.0 mm # 6



**Doyen**  
13-024-19  
19. cm / 7½"



**Doyen Myoma Screw**  
13-024-15  
15 cm / 6"

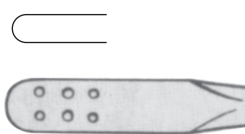
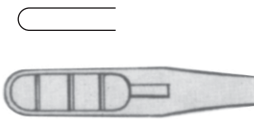

13-025-28 28 cm / 11"  
13-025-35 35 cm / 13¾"  
13-025-42 42 cm / 16½"

13-026-28 28 cm / 11"  
13-026-35 35 cm / 13¾"  
13-026-42 42 cm / 16½"

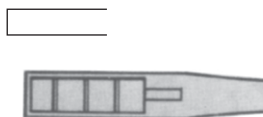

13-027-28 28 cm / 11"  
13-027-35 35 cm / 13¾"  
13-027-42 42 cm / 16½"

13-028-28 28 cm / 11"  
13-028-35 35 cm / 13¾"  
13-028-42 42 cm / 16½"



**Yeoman**



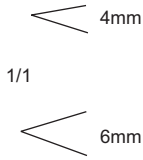

1/1



1/2

Schumacher  
13-029-04 4mm  
13-029-06 6mm  
28 cm / 11"



1/2

Tischler  
13-030-26  
26 cm / 10 1/4"

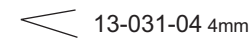

13-031-04 4mm

1/1

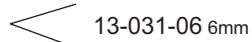

13-031-06 6mm

1/2

Schumacher  
13-031-04 - 13-031-06  
24 cm / 9 1/2"





Schubert  
13-032-21 21cm / 8½"  
13-032-29 29cm / 11½"

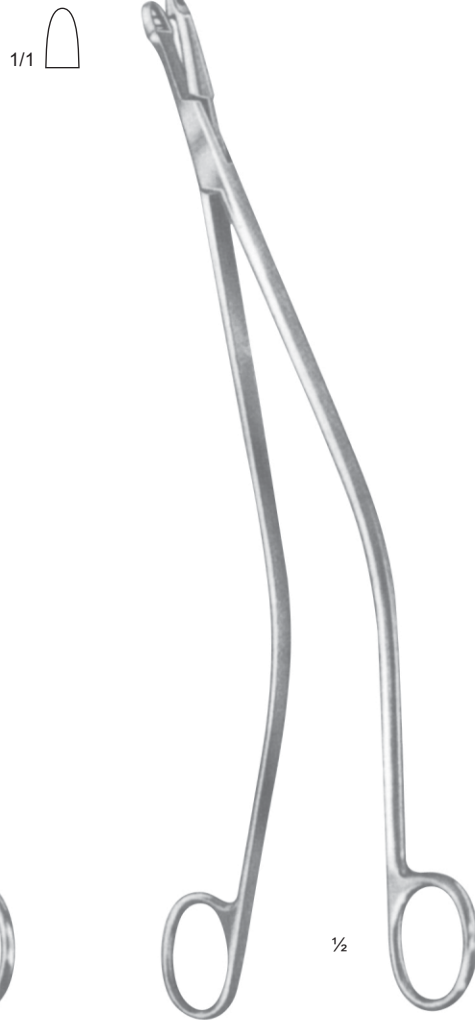

Schubert  
13-033-21  
26cm / 10¼"



Van Doren  
13-034-26  
26cm / 10¼"





Van Doren  
13-035-28  
28 cm / 11"



Faure  
13-036-23  
23 cm / 9"



Gellhorn  
13-037-23  
23 cm / 9"

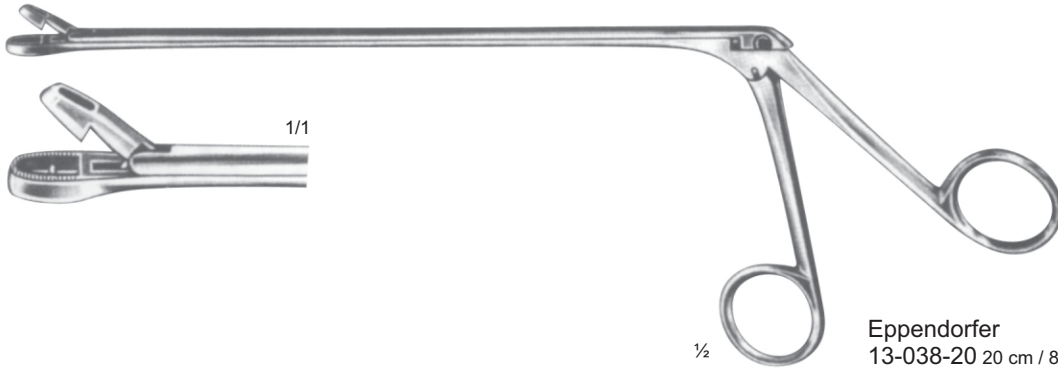

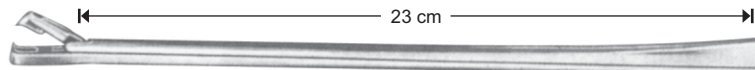

Tischler Morgan



Tischler Kevorkian



Tischler Morgan  
13-042-01  
13-042-02 Lock

Tischler Kevorkian  
13-043-01  
13-043-02 Lock  
23 cm / 9"

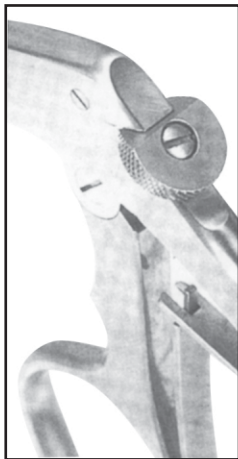

Lock of Shaft

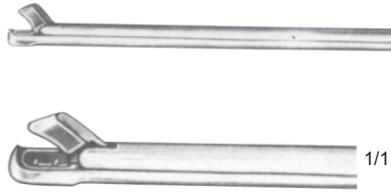

Tischler Mini  
13-044-01  
13-044-02 Lock  
20 cm / 8"

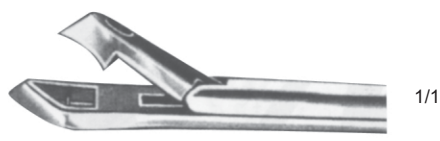

Tischler  
13-045-01  
13-045-02 Lock

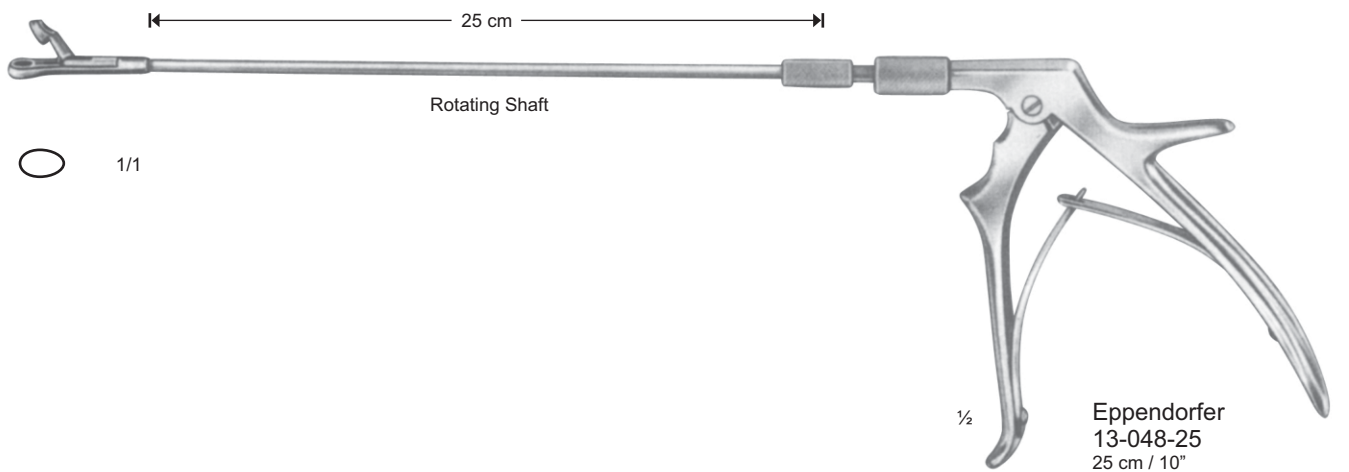
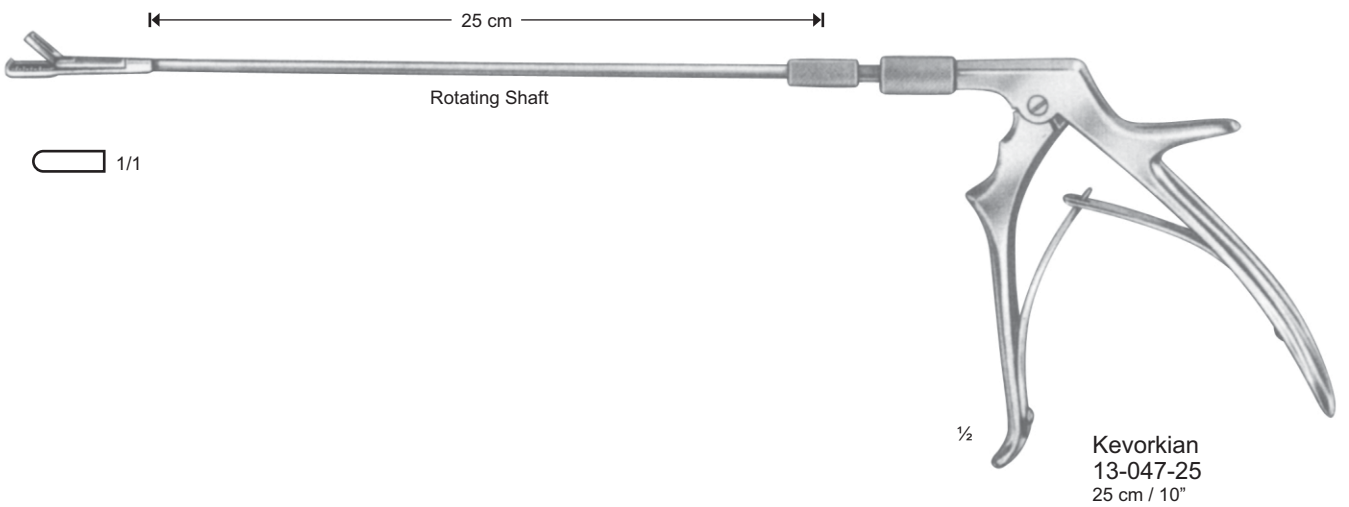
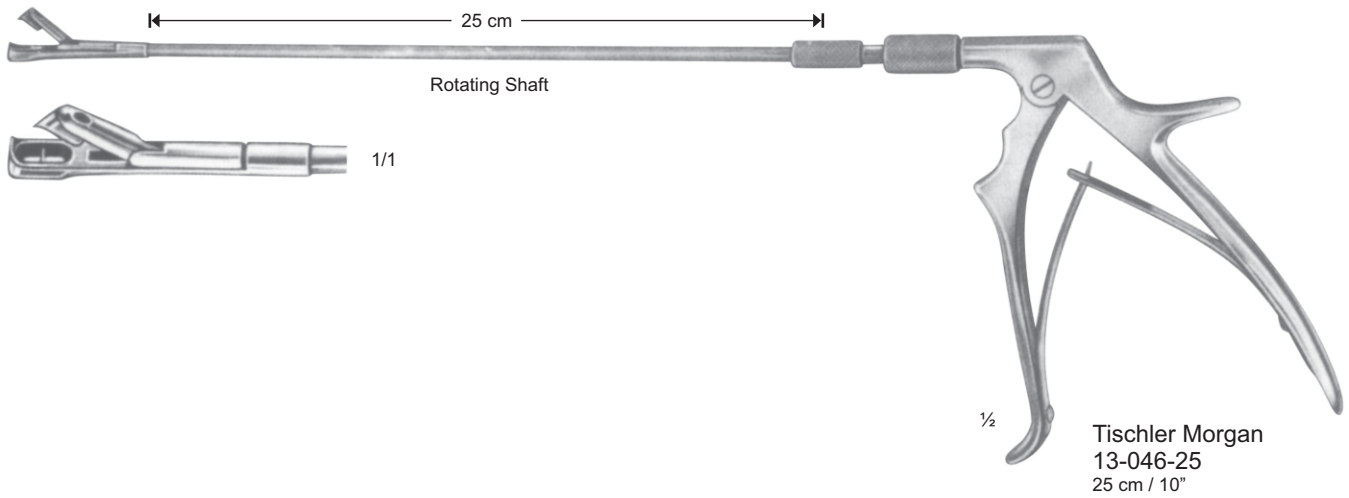

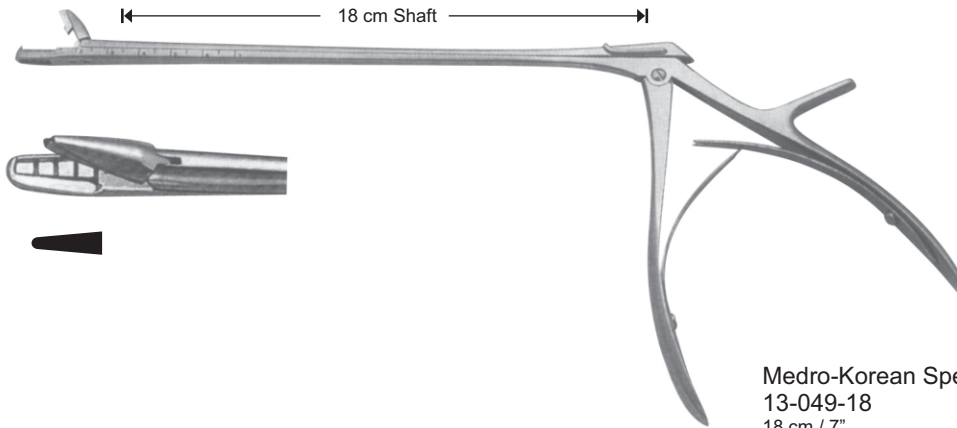

**Medro-Korean Special**  
13-049-18  
18 cm / 7"



**Simpson**  
13-050-30  
30 cm / 12"



**Martin Pelvimeter**  
13-051-00  
30 cm / 12"  
Graduated in centimeters & Inches"

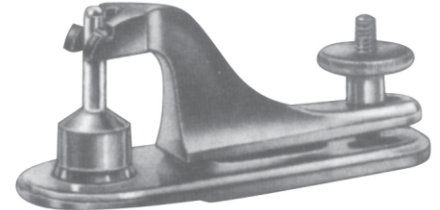

**Circumcision Clamp**  
13-052-09 09 mm  
13-052-11 11 mm  
13-052-13 13 mm  
13-052-15 15 mm  
13-052-21 21 mm  
13-052-25 25 mm  
13-052-28 28 mm  
13-052-30 30 mm  
13-052-32 32 mm



13-053-20 20 cm / 8"  
13-053-30 30 cm / 12"



Rogge  
13-054-23  
23 cm / 9"

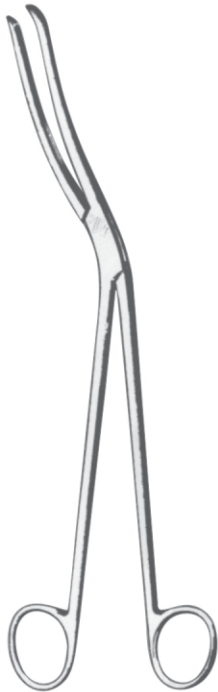

Cheatle  
13-055-27  
27 cm / 10½"



Mayo  
13-056-14  
14 cm / 5½"



Mayo  
13-057-14  
14 cm / 5½"





[www.krnano.com](http://www.krnano.com)

트레이

**BOWLS & TRAYS**

Page 256 - 260



**Emesis or Pus Basin**

14-001-00	200mm
14-001-01	250mm

**Sponge Bowl**

14-002-00	Ø45x25mm
14-002-01	Ø55x30mm
14-002-02	Ø75x35mm
14-002-03	Ø80x40mm
14-002-04	Ø90x45mm
14-002-05	Ø105x50mm
14-002-06	Ø125x55mm
14-002-07	Ø145x60mm
14-002-08	Ø165x70mm

**Instrument Tray**

14-003-00	Ø230x130x45mm
14-003-01	Ø260x170x50mm
14-003-02	Ø320x200x50mm
14-003-03	Ø415x250x65mm
14-003-04	Ø510x325x55mm

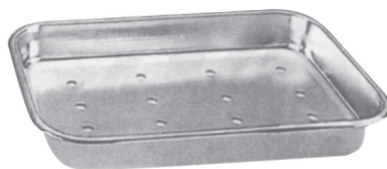
**Perforated  
Sterilization Tray**

14-004-00	Ø230x130x45mm
14-004-01	Ø260x170x50mm
14-004-02	Ø320x200x50mm
14-004-03	Ø415x250x65mm
14-004-04	Ø510x325x55mm



Needle or Ointment jar  
14-005-00 Ø75x60mm  
14-005-01 Ø90x50mm

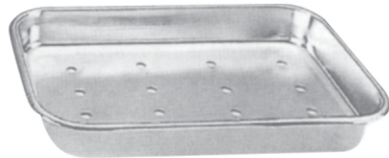

Perforated  
Sterilization Tray

	W	L	H
14-006-00	228	128	50mm
14-006-01	253	163	50mm
14-006-02	315	197	55mm
14-006-03	417	252	65mm
14-006-04	512	327	65mm



Instruments Tray  
Without lid

	W	L	H
14-007-00	215	175	25mm
14-007-01	250	200	40mm
14-007-02	280	200	50mm
14-007-03	360	320	60mm
14-007-04	530	430	80mm

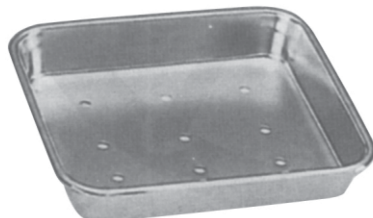

Porforated  
Instruments Tray

	W	L	H
14-008-00	215	175	25mm
14-008-01	250	200	40mm
14-008-02	280	200	50mm
14-008-03	360	320	60mm
14-008-04	530	430	80mm





## Dressing Jar

14-009-00	Ø 85 x 90 mm
14-009-01	Ø 115 x 120 mm
14-009-02	Ø 140 x 140 mm
14-009-03	Ø 170 x 170 mm

Instrument Tray  
with strap handle lid

14-010-00	230 x 130 x 45 mm
14-010-01	260 x 170 x 50 mm
14-010-02	320 x 200 x 55 mm
14-010-03	370 x 270 x 75 mm

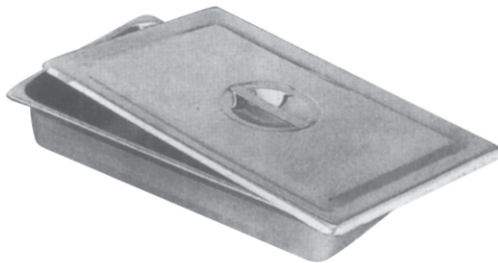
Instrument Tray  
with recessed handle Lid

14-011-00	265 x 165 x 63 mm
14-011-01	325 x 175 x 63 mm
14-011-02	325 x 265 x 63 mm
14-011-03	530 x 325 x 63 mm



## Dressing Package tray

	W	x	L	x	H
14-012-00	140	x	230	x	30mm

Catheter tray with  
strap handle lid

	W	x	L	x	H
14-013-00	450	x	120	x	60 mm (Large)
14-013-01	220	x	80	x	35 mm (Small)



Forcep jar

- 14-014-00 Ø 55 x 110 mm
- 14-014-01 Ø 50 x 130 mm
- 14-014-02 Ø 55 x 160 mm
- 14-014-03 Ø 76 x 200 mm
- 14-014-04 Ø 100 x 180 mm



Sterilizing Drum

- 14-015-00 Ø 150 mm
- 14-015-01 Ø 180 mm
- 14-015-02 Ø 250 mm
- 14-015-03 Ø 270 mm

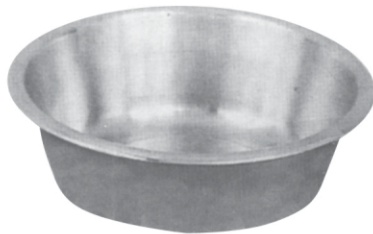

Solution bowl

- 14-016-00 Ø 305 x 105 mm
- 14-016-01 Ø 310 x 110 mm
- 14-016-02 Ø 345 x 115 mm
- 14-016-03 Ø 370 x 120 mm



Wash basin

- 14-017-00 Ø 350 x 110 mm





Enema can  
14-018-00 Ø 120 x 170 mm

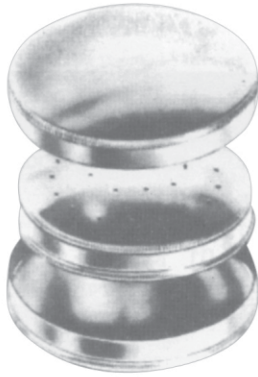

Micro Tray  
Complete  
14-019-00



Insert Only  
14-020-00



Micro Tray  
14-021-00

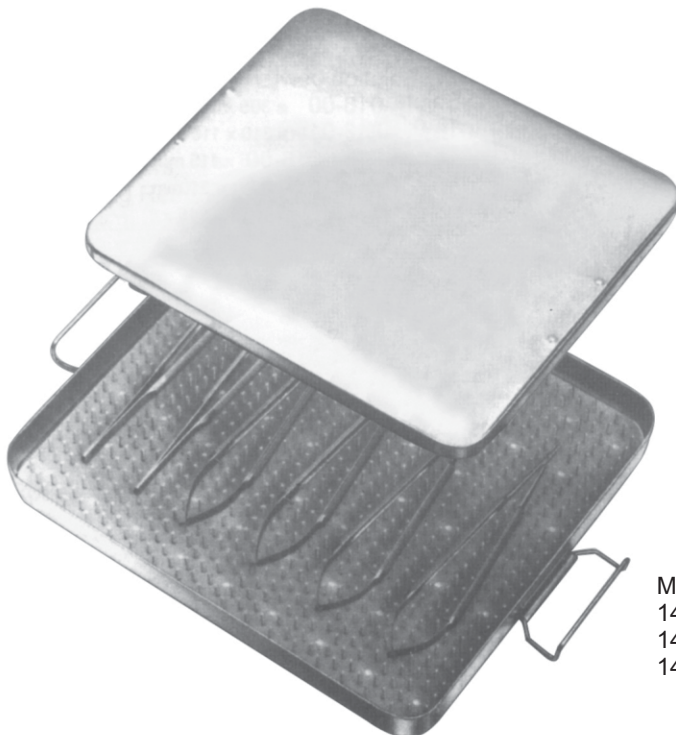
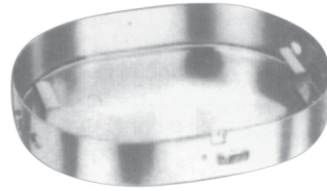

Micro Instruments Tray  
14-022-20 200 x 100 x 25 mm  
14-023-23 230 x 130 x 25 mm  
14-024-27 275 x 230 x 25 mm

Cusco Vaginal Speculams.....	238
Cushing Dressing Forceps.....	88
Cushing Dressing Forceps TC.....	92
Cushing Elevators.....	140,212
Cushing Hooks.....	137
Cushing Laminectomy Ronguer.....	132
Cushing-Taylor Dressing Forceps TC.....	92
Cuticle Scissors.....	195
Cuticle Scissors, Dermal Punches & Rectal Speculam.....	195
Czerny Rectal Specula.....	195

## D

Daily Knives.....	119
Dandy Artery Forceps.....	50
Davis - Boyle Mouth Gags.....	170
Day Ear Hooks.....	179
Dean Knives.....	118
Deaver Hand Retractor.....	151-152
Debakey & Splinter Forceps.....	94
Debakey Forceps.....	69-74,94
Debakey Needle Holders TC.....	81
Debakey Self Retaining Retractors.....	154
Debakey-Hess Bulldog Clamps.....	70
Debakey-Satinsky Debakey Forceps.....	73
Dejerine Diagnostic Hammers.....	5
Delicate Dressing & Tissue Forceps.....	91
Delicate Scissors, General & TC.....	14, 18,20,29-32,41
Denhart Mouth Gag.....	171
Derf General Needle Holders.....	78
Derf Needle Holders Tungsten Carbide.....	80
DERMAL & RECTAL INSTRUMENTS.....	192-196
Dermal Curettes.....	192
Desjardin Scoop.....	239
Desmarres Eye Caliper & Retractors.....	114
Desmarres Knives.....	119
Desmarres Retractors.....	142
Diagnostic Instruments.....	003-010
Diagnostic Hammers.....	5
Dieffenbach Bulldog Clamps.....	70
Dietrich Fine Operating Scissors SC.....	44
Dietrich Fine Operating Scissors TC.....	32
Dietrich Operating Scissors.....	19
Dilators & Probes.....	189
Dissecting Set.....	6
Dissector.....	137
Double Action Rongeurs.....	205-208
Douglas Cilia Forceps.....	95
Doyen Gynecological Operating Scissors SC.....	45
Doyen Gynecological Scissors.....	21
Doyen Gynecological Scissors TC.....	33
Doyen Hammer (Mallet).....	225
Doyen Intestinal Forceps.....	65
Doyen Myoma Screw.....	245
Doyen Raspatories.....	211
Doyen Uterine Polypus Forceps.....	62
Dressing & Tissue Forceps.....	086-095
Dressing Forceps.....	86,88
Dressing Jar.....	258
Dressing Package Tray.....	258
Duncan Utrine Curette.....	242
Duval Tissue Forceps.....	64

## E

Ear Curettes.....	178-179
Ear Forceps.....	182
Ear Knives.....	180
Ear Speculas, Curettes & Loops.....	178
Echlin (Duckbill) Ronguer.....	206
Elevators.....	138-141
Elevators & Nasal Knives.....	176
Elsching Knives.....	119
Emesis Or Pus Basin.....	256
End Cutter Tc.....	235
Enema Can.....	260
ENT Insruments.....	168-190

Episiotomy Scissors.....	023,35
Episiotomy Scissors TC.....	35
Eppendorfer Biopsy Forceps.....	249,251
Esmarch Plaster Shear.....	22
Eves Tonsil Snares.....	169
Eye Caliper & Retractors.....	114
Eye Speculam Forceps.....	98

## F

Farabeuf - Lambotte Forceps.....	202
Farabeuf Hand Retractors.....	152
Faure Biopsy Forceps.....	248
Feilchenfeld Forceps.....	94
Ferguson Vaginal Retractors.....	239
FerrisSmith-Kerrison Laminectomy Ronger.....	136
Fiber Handle,Elevators,Cheisels, Gonger,Screw Drives.....	215-217,220-222
Fine Operating Scissors.....	018-019,030-032,042-044, 121-124
Finger Reposition Forceps.....	199
Finger Retractors.....	144
Finger Ring Cutter.....	192
Finochietto Rib Spreader.....	164
Finochietto-Baby Haight.....	164
Finochietto-Child.....	164
Finsen Retractors.....	153
Fixing Vasectomy Set.....	75
Flat Nose Wire Holding Pliers.....	231
Flexible Retractors.....	142
Fomon Delicate Scissors.....	122,123,124
Fomon Files.....	129
Fomon Fine Operating Scissors TC.....	42
Fomon Knives.....	125
Fomon Skin Hooks.....	127
Forcep Jar.....	259
Forceps & Clamps.....	49-75
Foreign Body Removers.....	183
Forester Sponge Forceps.....	58
Fox Curette.....	195
Frazier Hooks.....	137
Frazier Suction Tubes.....	186
Freer Elevators.....	140,176
Friedmen Bone Ronguer.....	203

## G

Gorney Operating Scissors Tc.....	29
Gorney Fine Operating Scissors SC.....	41
Gemini Artery Forceps.....	55
Glover Debakey Forceps.....	69
Gillies General Needle Holders.....	79
Gillies Needle Holders Tungsten Carbide.....	82
Gillies Dressing Forceps.....	88
Gillies Tissue Forceps TC.....	93
Graefe Micro Hooks.....	115
Gsrger Knives.....	118
Gill Knives.....	119
Guthrie Knives.....	119
Guyton Knives.....	119
Gorney Fine Operating Scissors.....	121
Gorney Rhino Plastic Forceps.....	121
Gillies Skin Hooks.....	127
Gigli Saw Handle.....	130
Graham Hooks.....	137
Graefe Hooks.....	142
Guthrie Hooks.....	142
Gelpi Self Retaining Retractors.....	154
Gosset Abdominal Retractors.....	159
Goldsmith Nasal Speculam.....	173
Gerzong - Sexton Ear Knife.....	180
Giertz - Stille Rib Shear.....	198
Gluck Rib Shear.....	198
Gouge for removing broken scrow.....	221
Gellhorn Biopsy Forceps.....	248
Graefe Knives.....	119,120
Gouges.....	217,218,221
Gynecological Operating Scissors.....	21,23,33,35,45
Gynecology & Obstrical Instruments.....	238-253

Gynecological Forceps.....	59-61
General Needle Holders.....	78-79

## H

Haab Knives.....	119
Haberer Tongue Depressor.....	172
Haemorrhoidal Forceps.....	194
Haemorrhoidal Forceps & Ligature Section Tube.....	194
Haemorrhoidal Suction Ligator.....	194
Haight Retractors.....	165
Halsey General Needle Holders.....	78
Hajek Mallet 224.....	224
Halsey Needle Holders Tungsten Carbide.....	80
Halsted-Mosquito Hemostatic Forceps.....	49
Hemostatic Forceps.....	49
Hand & Infant Retractors.....	153
Hand Retractors.....	152-153
Hank (Double EN) Utrine Dilators.....	241
Hartman Ear Forceps.....	183-185
Hartman Ronguer.....	203
Hartmann - Halle.....	173
Hartmann Hemostatic Forceps.....	49
Hartmann Nasal Speculum.....	174
Hartmann Tonsil Punch.....	168
Heaney General Needle Holders.....	79
Heaney Hysterectomy Forceps.....	56
Hegar Dilators.....	241
Hega-BaumgartnerGeneffil Needle Holders.....	78
Hegar-Baumgartner Needle Holders TC.....	80
Hennig Cast Spreader.....	199
Hepp/Scheidel Micro Scissors.....	102
Hercules Pin Cutter TC.....	235
Heymann Fine Operating Scissors SC.....	42
Heymann Fine Operating Scissors TC.....	30
Heymann-Knight Delicate Scissors.....	122
Heywood Uterine Polypus Forceps.....	61
Hibbs Retractors.....	147
Hirschmann Anoscope.....	196
Hirst's Catheter Forceps.....	59
Hoen Elevators.....	138
Hoen Hooks.....	137
Holscher Elevators.....	141
Hooks.....	137
Hooks & Retractors.....	142
Horsley Elevators.....	138
House - Dieter Micro Forceps.....	184
Howman Bone Skids.....	226-228
Hudson Drill.....	223
Hunter Splinter Forceps.....	94
Hysterectomy & Artery Forceps.....	56

## I

Impactors.....	213
Inge-Child Spreader.....	162
Inge-Concave Spreader.....	162
Inge-Flat Spreader.....	162
Insert Only Of Micro Trav.....	260
Instrument Tray.....	256-260
Instrument Tray With Recessed Handle Lid.....	258
Iowa Utrine Forcep.....	60
Iris Delicate Dressing Forceps.....	91
Iris Fine Operating Scissors.....	18-19
Iris Fine Operating Scissors SC.....	43
Iris Operating Scissors TC.....	31
Israel & Doyen Retractors.....	50
Ives - Fansler Anoscope.....	196

## J

J.O.M.W. Utrine Curettes.....	244
Jaeger Knives.....	118
Jaeger-Grieshaber Knives.....	118
Jameson Delicate Scissors.....	123
Jameson Fine Operating Scissors SC.....	44
Jameson Fine Operating Scissors TC.....	32
Jameson Scissors.....	20
Jansen Ear Forceps.....	182

Jansen Retractors.....	153
Jennings Mouth Gags.....	170
Jewett Bending Iron.....	236
Johns-Hopkins Bulldog Clamps.....	70
Johnson Knives.....	119-120
Jones Towel Clamp.....	57
Joseph Elevators.....	176
Joseph Files.....	128
Joseph Knives.....	125
Joseph Skin Hooks.....	126
Judd-Allis Forceps.....	63

## K

Kogan Endocervical Specutarn.....	239
Katsch Dermal Curette.....	192
Kelly Artery Forceps.....	50
Kelly Operating Scissors.....	17
Kelly Operating Scissors SC.....	40
Kelly Operating Scissors TC.....	28
Kelly Richardson Retractors.....	149
Kelly Uterine Polypus Forceps.....	61
Kern Bone Holding Forceps.....	200
Kevorkain Biopsy Forceps.....	249,251
Kevorkian Utrine Curette.....	242
Keyes Dermal Punch.....	195
Kidney Forceps.....	67
Killian Nasal Speculum.....	175
Kilner Delicate Scissors.....	122
Kilner Fine Operating Scissors SC.....	42
Kilner Fine Operating Scissors TC.....	30
Kilner Skin Hooks.....	127
Kirschner (Pin Cutter) Tc.....	234
Kirschner Wire Traction Bows.....	210
Kleinert Skin Hooks.....	126
Knapp Knives.....	120
Knapp Micro Scissors.....	104
Knapp Micro Scissors Super Cut.....	108
Knapp Micro Scissors Tungsten Carbide.....	106
Knight Nasal Scissors.....	183
Koacher & Middledorf Retractors.....	148
Kocher Intestinal Forceps.....	66
Kocher Retractors.....	150
Kocher(Ochsner) Artery Forceps.....	54
Kuhnt Knives.....	120

## L

Labarde Dilator Forceps.....	168
Labsche Septum Knife.....	212
Lahey Hysterectomy & Artery Forceps.....	56
Lahey Skin Hooks.....	126
Lambotte Osteotomes.....	219
Laminectomy Ronger.....	132-136
Lane Bone Holding Forceps.....	200
Lange - Howman Bone Skid.....	228
Lange Skin Hooks.....	126,127
Langenbeck Amputation Saw.....	229
Langenbeck Needle Holders TC.....	84
Laryngoscopes.....	7,8,9,10
Leksell Ronguer.....	208
Lemon Bailey Retractors.....	166
Lempert Bone Ronguer.....	204
Lempert Curettes.....	178
Lewin Bone Holding Forceps.....	199
Lewis Bone Files.....	128
Lexer Osteotomes.....	220-221
Lindemann Amputation Saw.....	229
Lister Bandage Scissor SC.....	46
Lister Bandage Scissor TC.....	34
Lister Bendage Scissors.....	22
Lister Utility Scissors.....	22
Liston Bone Cutters.....	209
Littauer Stitch Scissor.....	20
Lnge Spreader.....	162
Lockwood Tissue Forceps.....	63
Logan Retractors.....	153
Love Gruenwald Laminectomy Ronger.....	132
Love Retractor.....	140

Lowman Bone Clamp.....	200
Lucae Ear Forceps.....	182
Lucae Ear Knives.....	180
Luer Bone Ronguer.....	204
Lundsgaard Knives.....	119

**M**

Magill Catheter Forceps.....	59
Mallets.....	129,224,225
Markham-Meyerding	
Self-Retaining Laminectomy Retractors.....	163
Martin Pelvimeter.....	252
Mathieu General Needle Holders.....	79
Mathieu Needle Holders Tungsten Carbide.....	83
Mathieu Rectal Speculum.....	196
Mayo Forcep Clips.....	253
Mayo Operating Scissors.....	16
Mayo Operating Scissors SC.....	39
Mayo Operating Scissors TG.....	27
Mayo Utrine Probes, Sounds.....	240
Mayo-Hegar General Needle Holders.....	78-79
Mayo-Hegar Needle Holders TC.....	81
Mayo-Hegar(Heaney) Needle Holders TC.....	81
Mayo-Noble Operating Scissors.....	17
Mayo-Noble Operating Scissors SC.....	40
Mayo-Noble Operating Scissors TC.....	28
Mayo-Robson Intestinal Forceps.....	65
Mayo-Stille Operating Scissors.....	16
Mayo-Stille Operating Scissors SC.....	39
Mayo-Stille Operating Scissors TC.....	27
Mc Givney Haemorrhoidal Forceps.....	194
Mcindoe Dressing Forceps.....	88
Mcindoe Dressing Forceps TC.....	93
Mcintosh Fiber Optic Laryngoscopes Set.....	10
Mcintosh Laryngoscopes Set.....	9
Mcivor Mouth Gag Frame.....	170
McReynolds Knife.....	119
Mead Mellet.....	129,224
Medro - Korean Special Biopsy Forceps.....	252
Medro Mallet.....	129,224
Medro Mallet Fiber Handle.....	225
Medro Mallet With Plastic Disc.....	225
Metal - Alloy Tuning Folks.....	181
Metzenbaum Operating Scissors.....	17-18
Metzenbaum Operating Scissors SC.....	40,41
Metzenbaum Operating Scissors TC.....	28,29
Meyerding Self-Retaining Laminectomy Retractors.....	163
Meyhoefer Micro Hooks.....	115
Micro Ear Forceps.....	183-185
Micro Forceps.....	90,100
Micro Hooks.....	115
Micro Instrument Tray.....	260
Micro Jeweler's Forceps.....	28,29,90
Micro Needle Holders.....	109-113
Micro Scissors.....	101-108
Micro Scissors Super Cut.....	107-108
Micro Scissors Tungsten Carbide.....	105-106
Micro Suture Tying Micro Forceps.....	100
Micro Tray.....	260
Micro-Adson Dressing Forceps.....	88
Micro-Adson Dressing Forceps TC.....	92
Micro-Castroviejo Needle Holders.....	109
Micro-Castroviejo Needle Holders TC.....	109,112
Micro-Mosquito Hamostatic Forceps.....	49
Microvascular Needle Holders TC.....	81
Miller Fiber Optic Laryngoscopes Set.....	8
Miller Laryngoscopes Set.....	7
Miller Skin Retractor.....	127
Mini - Howman Bone Skid.....	226
Mini - Lexer Gouges.....	221
Mini - Lexer Osteotomes.....	220
Mini Adson Tissue Forceps.....	87
Mini Kevorkian Utrine Curette.....	242
Mirrors, Tonsil Punch, Curetess & Dilator Forceps.....	168
Mixer Baby Artery Forceps.....	51,56

Mod - Wien Nasal Speculam.....	174
Mod Medro Tiek Speculam.....	174
Mod.Hamburg Knives.....	120
Mod.Tubinge Knives.....	120
Mod.USA Episiotomy Scissors.....	23
Mollison Weitlaner Retractors.....	155
Molt Mouth Gags.....	171
Mouth Gags.....	170-171
Mouth Gags & Elevators.....	171
Myoma Screw & Biopsy Forceps.....	245

**N**

Nail Cutters.....	193
Nail Cutters & Nippers.....	193
Nail Nippers.....	193
Narrow Kogan Speculam.....	239
Nasal Osteotomes.....	177
Nasal Speculams.....	173-175
Needle Holders.....	078-084,109-113
Needle Or Ointment Jar.....	257
Neuro Surgery Instruments.....	132-142
Niederdelmann Osteotomes, Curved.....	219
Novak - Schoeckaert Curette.....	186

**O**

Obwegeser Elevator.....	171
Obwegeser Osteotomes, Cvd.....	219
Ochsner Trocars.....	186
O'Connor Hooks.....	142
Olsen-Hegar Needle Holders TC.....	82
Operating Scissors.....	13-46
Ophthalmic Surgery Instruments.....	98-115
ORTHOPEDIC INSTRUMENTS.....	198-236
Oslen-Hegar General Needle Holders.....	79
Osteotomes Curved.....	220
Osteotomes Straight.....	220
O'Sullivan-O'Connor Abdominal Retractors.....	160

**P**

Papst Knives.....	118
Parker Hand Retractors.....	152
Partch Mallet.....	129
Parthes Screw.....	223
Partsch - Chisels.....	218
Partsch - Gouges.....	218
Paton Knives.....	119
Paufique Knives.....	119
Payr Intestinal Clamp Intestinal Forceps.....	68
Payr Pylourus Intestinal Clamp.....	68
Pean (Rochester) Artery Forceps.....	53
Pean Artery Forceps.....	52
Peet Splinter Forceps.....	95
Penfield Elevators.....	139
Perforated Sterilizing Trays.....	256-257
Placenta Forceps.....	59
Plastic Surgery Instruments.....	118-130
Plate Benders.....	236
Politzer Ear Knives.....	180
Polypus, Tumor, Swab Forceps.....	58
Poole Suction Tubes.....	188
Potts-Smith Fine Operating Scissors SC.....	44
Potts-Smith Fine Operating Scissors TC.....	32
Potts-Smith Scissors.....	20
Potts-Smith Tissue Forceps.....	89
Potts-Smith Tissue Forceps TC.....	93
Potts-Smith Vascular Scissors.....	32
Pozzi Tenaculam Forceps.....	61
Pratt Rectal Speculam.....	195
Probes.....	189-190
Putti Bone Files & Rasps.....	230

**R**

Ragnell Retractor.....	128
Ralk Splinter Forceps.....	95
Rampley Sponge Forceps.....	58
Randall Curette.....	186
Randall Kidney Forceps.....	67
Raspatories & Bone Hooks.....	211



Raspatories & Elevators.....	212
Rectal Speculam & Anoscopes.....	196
Reil Micro Scissors.....	102
Reill Bone Cutter Tc.....	235
Reill Reposition Forceps.....	199
Retractors.....	144-166
Reynolds Delicate Scissors.....	122
Reynolds Fine Operating Scissors SC.....	42
Reynolds Fine Operating Scissors TC.....	30,122
Rhino Plastic Forceps & Scissors.....	121
Rhotton Micro.Forceps.....	100
Rib Shears.....	198
Rib Spreader.....	164-165
Rib Spreaders Retractors.....	161
Richardson Eastman Retractors.....	149
Richardson Retractors.....	149
Richter Bandage Scissor.....	22
Richter Episiotomy Scissors.....	22
Rochester Carmalt Artery Forceps.....	51
Rogge Sterlizing Forcep.....	253
Rottgen - Ruskin Ronguer.....	205
Roux Hand Retractors.....	152
Rowland Knives.....	118
Rubin Rhino Plastic Forceps.....	121
Ruskin - Liston.....	209
Ruskin Mini.....	205
Ruskin Rongers.....	205
Russ.Modell Micro Forceps.....	90
Ryder Vascular Needle Holders TC.....	82
Ryder(Medro) Needle Holders TC.....	82

## S

Saalfeld Curette.....	192
Sachs Elevators.....	138
Sachs Hooks.....	137
Sakurais Black Vaginal Speculam.....	238
Sakurais Vaginal Speculam.....	238
Sato Knives.....	120
Satterlee Saw.....	230
Scalpel Handles.....	003-004
Scheid Knives.....	119
Schnaudigl Knives.....	120
SchnidtArtery Forceps.....	51
Schnidt Tonsil Forceps.....	169
Schroeder Tenaculum Forceps.....	61
Schubert Biopsy Forceps.....	247
Schumacher Biopsy Forceps.....	246
Scissors.....	13-44,101-108,121-124
Scissors.Super.Cut.....	036-046,107-108
Scissors Tungsten.Carbide.....	24-35,105-106
Scoville Elevators.....	141
Scoville Frame Only Rib Spreaders Retractors.....	161
Scoville Rib Spreaders Retractors.....	161
Scoville-Haverfielf Rib Spreaders Retractors.....	161
Screw Drivers.....	222
Searchy Knives.....	119
Self Retaining Retractors.....	154,156,157
Self-Retaining I.am.nectomy Retractors.....	163
Semb Bone Cutter.....	210
Semi-Sharp Volkman Retractors.....	145
Semken Dressing Forceps.....	88
Semken Dressing Forceps TC.....	93
Senn-Muller Finger Retractors.....	144
Sexton Ear Knife.....	180
Sichel Knives.....	120
Simpson Obstetrical Forceps.....	252
Sims Blunt Utrine Curettes.....	243
Sims Gynaecological Operating Scissors SC.....	45
Sims Gynaecological Operating Scissors TC.....	33
Sims Gynecological Scissors.....	21
Sims Probes & Sounds.....	240
Sims Rectal Speculas.....	195
Sims Retractors.....	239
Sims Sharp Utrine Curettes.....	243

Sims Special Utrine Probes.....	240
Sims Utrine Curettes.....	244
Single Action Rongeurs.....	203-204
Skin Hooks.....	126,127,137,142
Smith - Peterson Chiesels.....	216
Smith - Peterson Gouges.....	217
Smith Peterson Rongeurs.....	207
Solution Bowl.....	259
Spencer Stitch Scissor.....	20
Spinal Elevators.....	215
Splinter & Cilia Forceps.....	95
Sponge Bowls & Trays.....	256-260
Spurling Laminectomy Ronger.....	132
Stainless Steel Handle(Volkman) Curette.....	214
Standard Kogan Speculam.....	239
Standard Operating Scissors SC.....	36-38
Standard Scalpal Handles.....	3
Standard TC Operating Scissors.....	24-26
Standard Tube Clumps.....	57
StandardIDressing Forceps.....	86
Standard/Op.Scissor.....	13-15
Staude-Moore Towel Clamp.....	58
Steinman Traction Bows.....	210
Sterilizing Drums.....	259
Stevens Fine Operating Scissors.....	19
Stevens Fine Operating Scissors TC.....	32
Stevens Micro Scissors Super Cut.....	107
Stevens Micro Scissors Tungsten Carbide.....	105
Stevens Micro Scissors(Ribbon).....	103
Stieglitz Splinter Forceps.....	95
Stille - Horsley Bone Cutter.....	209
Stille - liston Bone Cutter.....	210
Stille - Luer (Duckbill) Bone Rongeur.....	206
Stille - Ruskin Bone Rongeur.....	208
Stille Bone Rongeur.....	206
Stitch Scissors.....	20
Str. Smith Peterson Rongeur.....	207
Strabismis Delicate Scissors.....	123
Strabismis Fine Operating Scissors TC.....	31
Strabismus Fine Operating Scissors SC.....	43
Struempel Ear Forcep.....	185
Suction Tubes.....	186-188

## T

Kevorkian Tischler-Biopsy Forceps.....	250
Mini Tischler-Mini Biopsy Forceps.....	250
Morgan Biopsy Forceps.....	251
Morgan Tischler-Morgan Biopsy Forceps.....	250
Taylor Diagnostic Hammers.....	5
Taylor Dressing Forceps.....	89
Taylor Retractors.....	149
Taylor Rib Spreaders Retractors(Blades).....	161
TC Dressing & Tissue Forceps.....	92-93
TC Wire Cutting Pliers.....	234-235
Thoms-Allis Tissue Forceps.....	63
Thorax Scissors.....	20
Thorax, Vascular & Stitch Scissors.....	20
Thorek Delicate Scissors.....	123
Tieck - Halle Nasal Speculam.....	174
Tischler Biopsy Forceps.....	246-251
Tissue Dressing Forceps.....	86-87
Tissue Forceps.....	086-94
Tissue Forceps Allis.....	63
Tonsil Seizing Forceps & Snares.....	169
Took Knives.....	119
Tounge Depressors.....	172
Towel Forceps & Tubing Clamps.....	57
Toynbee Ear Speculas.....	178
Trabercular Micro Scissors.....	102
Trousseau Dilator Forceps.....	168
Tube Clamps.....	57
Tuftier Bailey Retractors.....	165
Tuftier Spatula.....	172
TC Micro Needle Holders.....	109,112-113

Tungsten Carbide Needle Holders.....	080-084
Tungsten Carbide Scissors.....	026-035
Tungsten Carbide Wire Twisters.....	83-84
Tuning Folk Set of 5.....	181
Tuning Folks.....	181
Turnbull Nail Cutter.....	193
Tyding Tonsil Snare.....	169

## U

Ulrich Bone Holding Forcep Cvd.....	201
Ulrich Bone Holding Forcep Str.....	62
Ulterine Polypus Forceps.....	223
Universal Drill.....	35
Universal Episiotomy Scissors TC.....	23
Universal Episiotomy Scissors.....	192
Unna Dermal Curette.....	153
Us-Army Retractor.....	242-244
Uterine Curettes.....	62
Uterine Polypus Forceps.....	59
Utrine & Catheter Forceps.....	252
Utrine Biopsy Punch, Pelvimeter Forceps Circumcision.....	241
Utrine Dilators.....	240

## V

Vaginal Spaculams.....	238-239
Van Doren Biopsy Forceps.....	247-248
Vannas very delicate Micro Scissors.....	102
Vannas-Tubingen Micro Scissors.....	102
Various Sterlizing Forceps.....	253
Vasectomy Set.....	75
Verbrugge Bone Holding Forceps.....	202
Volkman & Langenbeck Retractors.....	146
Volkman Retractors.....	145
Volkmann Bone Curettes.....	214
Voltolini Nasal Speculam.....	173
Von Graefe Tissue Forceps.....	91

## W

Wagner Delicate Scissors.....	123
Wagner Fine Operating Scissors SC.....	43
Wagner Fine Operating Scissors TC.....	31
Walker-Lee Knives.....	119
Wartenberg Pin Wheel.....	5
Wash Basin.....	259
Weber Knives.....	120
Webster General Needle Holders.....	78
Webster Needle Holders TC.....	80
Weeker Knives.....	118,119
Weiner Knives.....	118
Weitlaner Retractors.....	154-155
Weitlaner Self Retaining Retractors.....	154-155
Weitlaner-Locktite Retractors.....	155
Weitlaner-Wullstein Retractors.....	155
Westcott Micro Scissors.....	101
White Tonsil Seizing Forceps.....	169
Wieder Tongue Depressor.....	172
Wilde Ear Forceps.....	182
Wilder Micro Probe.....	115
Wire Cutter TC.....	234-235
Wire Cutting Pliers.....	232-235
Wire Holding Pliers.....	233
Wire Twister Needle Holders TC.....	83
Wire Twister TC(Heavy) TC.....	83
Wire Twister(Flat) Needle Holders TC.....	84
Wire Twister(Heavy) Needle Holders TC.....	84
With Rip Joint Verbrugge Bone Holding.....	202
Wittner Biopsy Forceps.....	249
Wolff Plaster Spreader.....	198

## Y

Yankaur Child Suction Tube.....	188
Yankaur Suction Tube.....	188
Yeoman Biopsy Forceps.....	245

## Y

Zaufal - Jansen.Bone Rongeur.....	205
Ziegler Knives.....	120



수입사  
주식회사 나노메드  
NANO MED CO., LTD

광주광역시 북구 첨단벤처소로51 A동 205호  
Tel 062-367-5700  
Fax 062-367-5701  
HP 010-3058-0430  
E-mail. cwo1411@naver.com



제조사  
WON PAKISTAN

Building No. 237, Zeeshan Street, Opposite  
Bank Al Habib Branch, Defence Road,  
Sialkot 51310, Pakistan  
Tel: +92-52-6227788  
Mob: +92-311-4905348  
E-mail: kjlee0700@hanmail.net