



www.krnano.com

조직 및 혈관포셉

FORCEPS & CLAMPS

Page 049 - 075

검사 및 분류(변형제품 제거)

오염 제거 및 세척 후 검사를 시행합니다.
 이 검사 과정은 팁 파손, 정렬 불량, 부식 및
 구부러짐 등 제품의 변형을 주로 확인해야 합
 니다.

사용 목적에 부합된 제품은 교체해야 합니다.
 긴박한 수술 도중 사용 목적과 부합된 목적으
 로 사용할 경우 기기의 성능이 저하될 수 있습
 니다.이럴 경우, 설계된 대로 작동하지 않으면
 교체해야 합니다.

검사준비 및 세척

세척을 위해 기구를 준비할 때 섬세하게 뚜껍
 으로 보호하십시오.

세척 중 기구의 열린 위치, 날카로운 포인트
 는 서로 닿아서는 안 되며,
 사용 후 세척을 준비할 때, 의료기구를 배치
 하는 것이 중요합니다.

필요한 경우 수건을 바닥에 깔고 의료기를 놓
 고 분리하면 의료기 상호 간에 마찰을 최소화
 할 수 있어서 밑부분을 보호할 수 있습니다.

**KGMP에서 요구하는 의료기 관리지침을
 준수하십시오**



2페이지의 재사용 의료기구의 관리를 참조하십시오

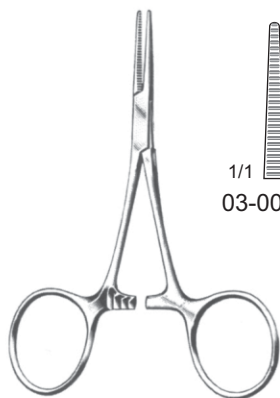

Hartmann
03-001-10 - 03-002-10
10 cm / 4"

1/1
03-001-10

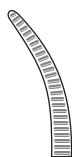

03-002-10

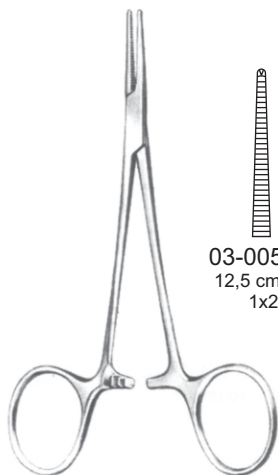

Halsted-Mosquito
03-003-12 - 03-006-14

1/1
03-003-12
12,5 cm / 5"

03-003-14
14 cm / 5½"

03-004-12
12,5 cm / 5"

03-004-14
14 cm / 5½"

03-005-12
12,5 cm / 5"
1x2

03-005-14
14 cm / 5½"
1x2

03-006-12
12,5 cm / 5"
1x2

03-006-14
14 cm / 5½"
1x2

1/1
03-007-10
10 cm / 4"

03-007-12
12 cm / 4¾"

03-008-10
10 cm / 4"

03-008-12
12 cm / 4¾"

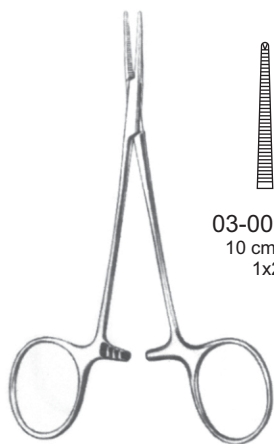

Micro-Mosquito
03-007-10 - 03-010-12

03-009-10
10 cm / 4"
1x2

03-009-12
12 cm / 4¾"
1x2

03-010-10
10 cm / 4"
1x2

03-010-12
12 cm / 4¾"
1x2

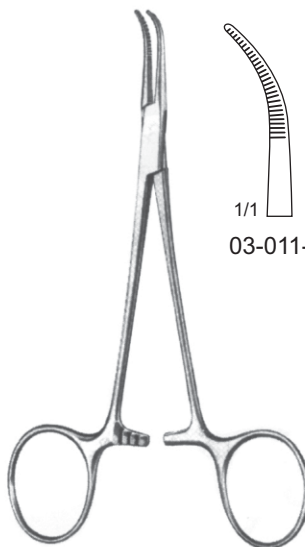

Baby-Mixer
03-011-01 - 03-011-02
14 cm / 5½"

1/1
03-011-01

03-011-02





Kelly
03-012-14 - 03-015-16

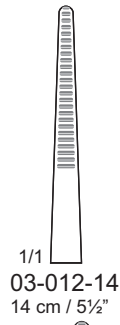

1/1
03-012-14
14 cm / 5½"

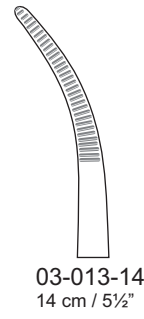

03-013-14
14 cm / 5½"

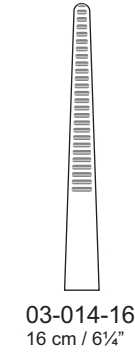

03-014-16
16 cm / 6¼"

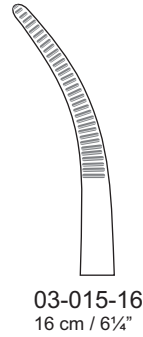

03-015-16
16 cm / 6¼"

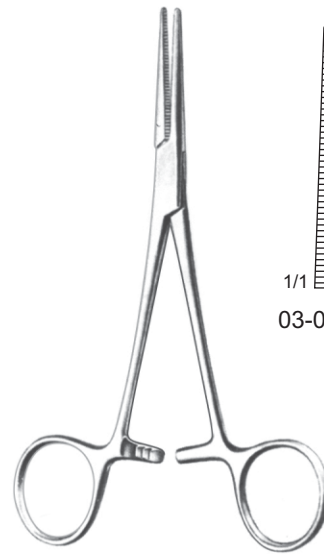

Crile
03-016-64 - 03-017-64
14 cm / 5½"

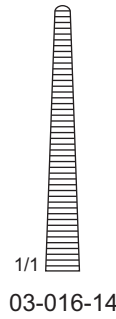

1/1
03-016-14

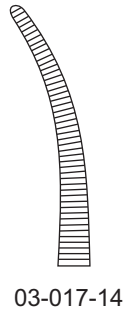

03-017-14



Crile-Rankin
03-018-16 - 03-019-16
16 cm / 6¼"

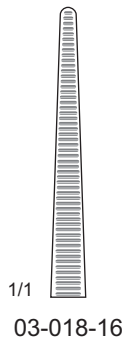

1/1
03-018-16

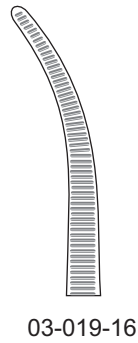

03-019-16

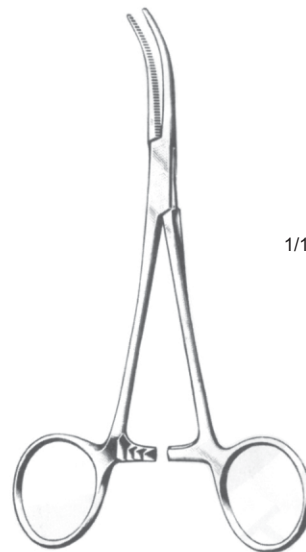

Dandy
03-020-16 - 03-021-16

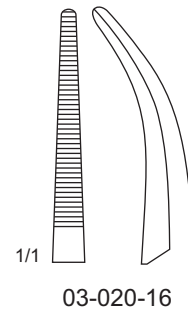

1/1
03-020-16

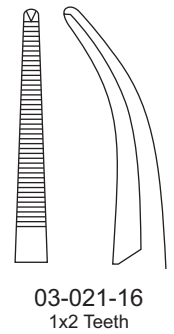

03-021-16
1x2 Teeth



Rochester Carmalt
03-022-16 - 03-023-20

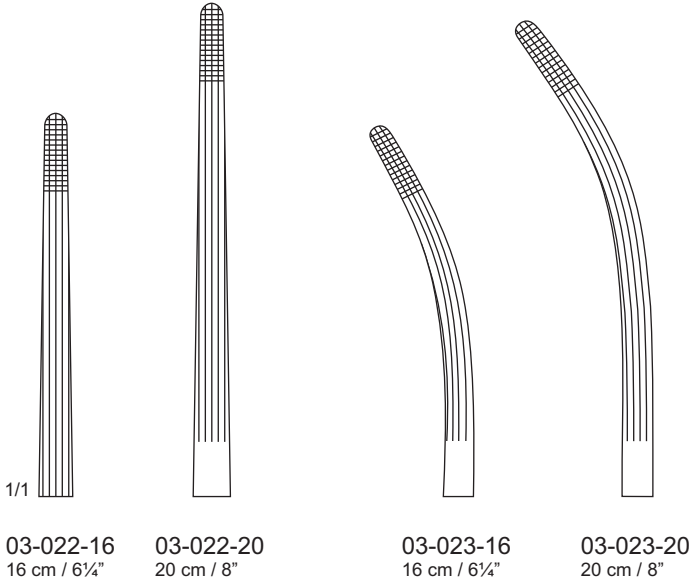

03-022-16
16 cm / 6 1/4"

03-022-20
20 cm / 8"

03-023-16
16 cm / 6 1/4"

03-023-20
20 cm / 8"



Schnidt
03-024-18 - 03-024-19

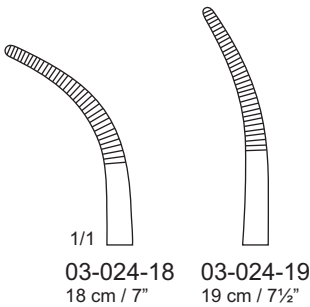

03-024-18
18 cm / 7"

03-024-19
19 cm / 7 1/2"

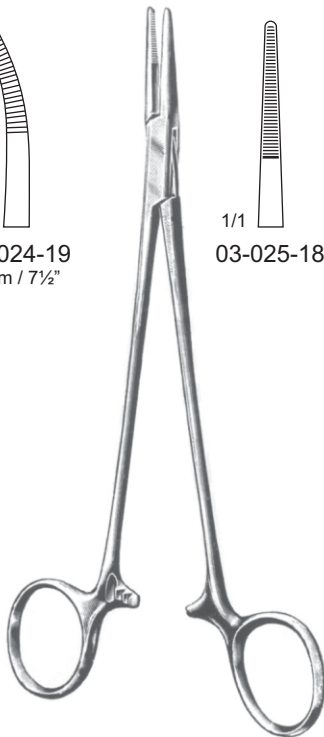

Adson
03-025-18 - 03-026-18
18,5 cm / 7 1/4"

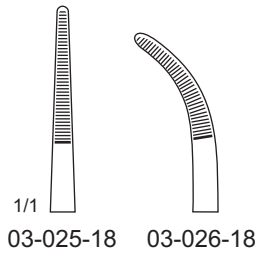

03-025-18

03-026-18

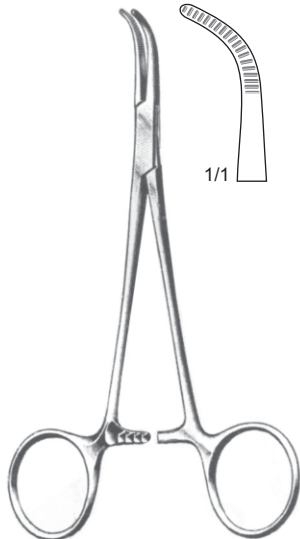

Mixer Baby
03-027-14
14 cm / 5 1/2"

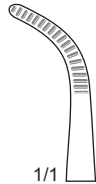

1/1





Péan (Delicate)
03-028-13 - 03-029-16

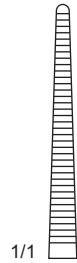

1/1
03-028-13
16 cm / 5"



03-028-14
14 cm / 5½"



03-028-16
16 cm / 6¼"



03-029-13
13 cm / 5"



03-029-14
14 cm / 5½"

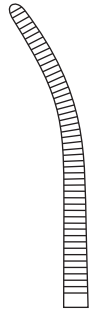

03-029-16
16 cm / 6¼"



Péan
03-030-13 - 03-031-16

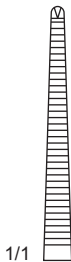

1/1
03-030-13
16 cm / 5"



03-030-14
14 cm / 5½"



03-030-16
16 cm / 6¼"



03-031-13
13 cm / 5"



03-031-14
14 cm / 5½"



03-031-16
16 cm / 6¼"

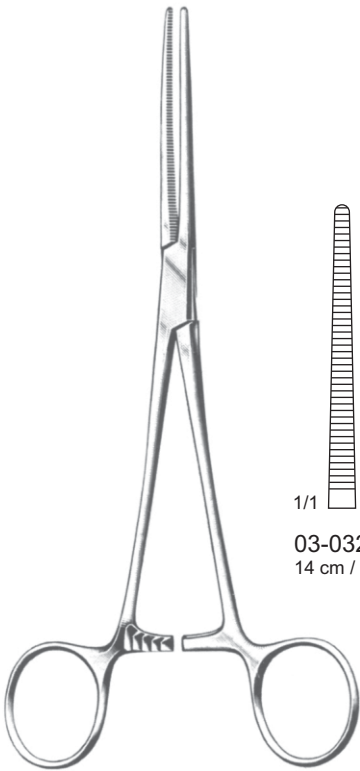

Péan (Rochester)
03-032-14 - 03-033-30

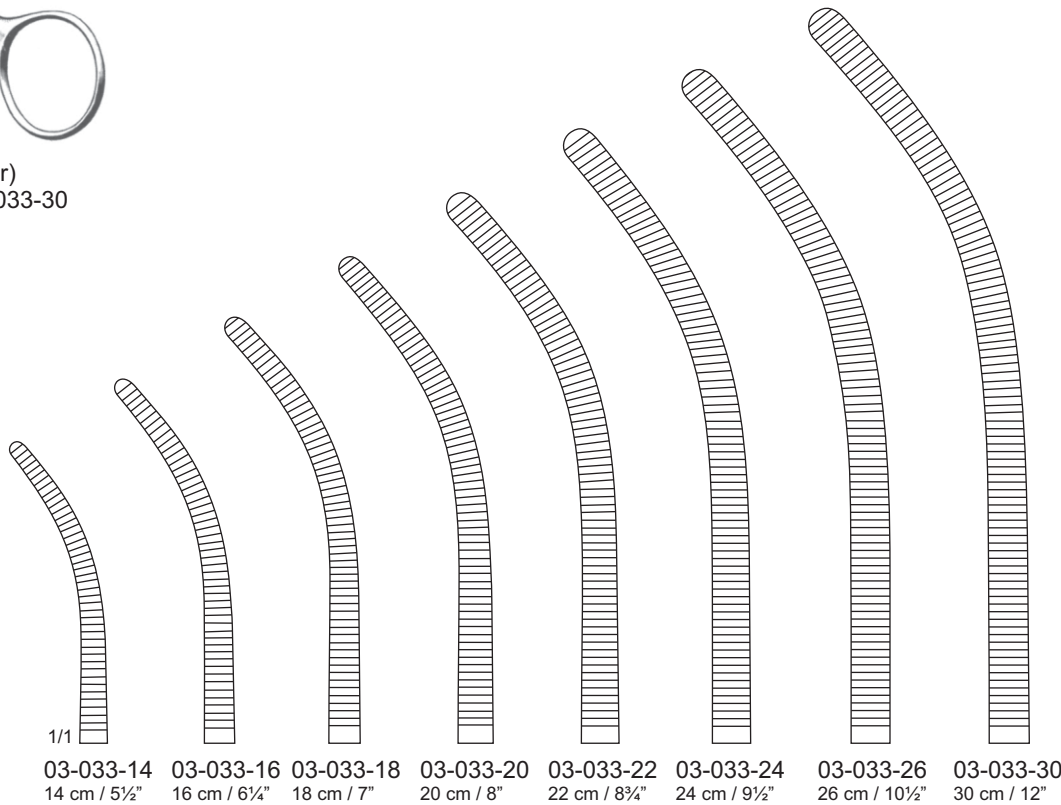
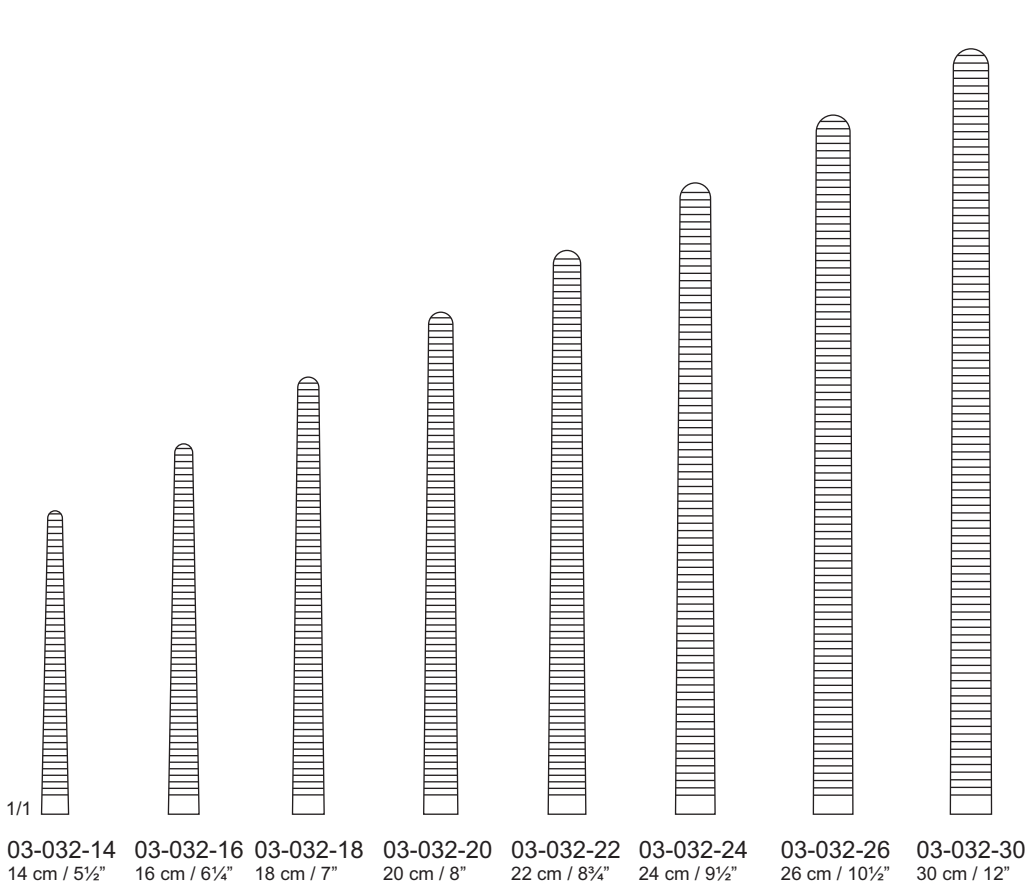

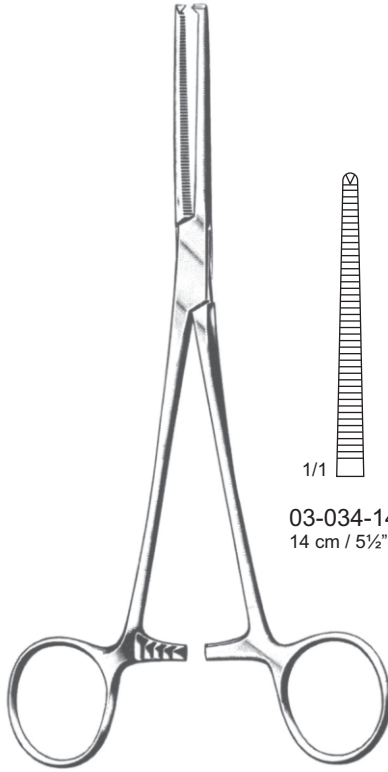

Kocher (Ochsner)
03-034-14 - 03-035-30

1/1

- 03-034-14
14 cm / 5½"
- 03-034-16
16 cm / 6¼"
- 03-034-18
18 cm / 7"
- 03-034-20
20 cm / 8"
- 03-034-22
22 cm / 8¾"
- 03-034-24
24 cm / 9½"
- 03-034-26
26 cm / 10½"
- 03-034-30
30 cm / 12"

1/1

- 03-035-14
14 cm / 5½"
- 03-035-16
16 cm / 6¼"
- 03-035-18
18 cm / 7"
- 03-035-20
20 cm / 8"
- 03-035-22
22 cm / 8¾"
- 03-035-24
24 cm / 9½"
- 03-035-26
26 cm / 10½"
- 03-035-30
30 cm / 12"

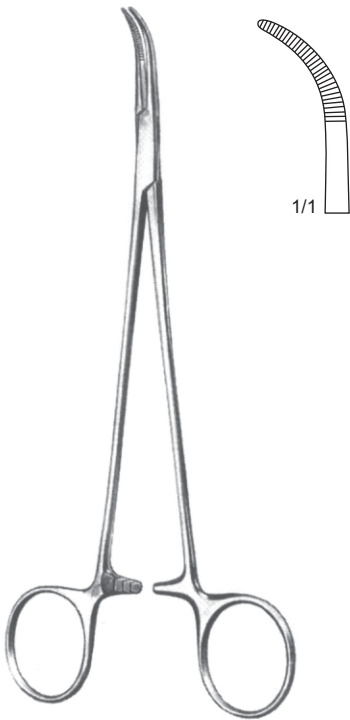

Baby-Mixer
03-036-18
18 cm / 7"



Baby-Adson
03-037-14 - 03-038-18

03-037-14
14 cm / 5½"

03-038-18
18 cm / 7"

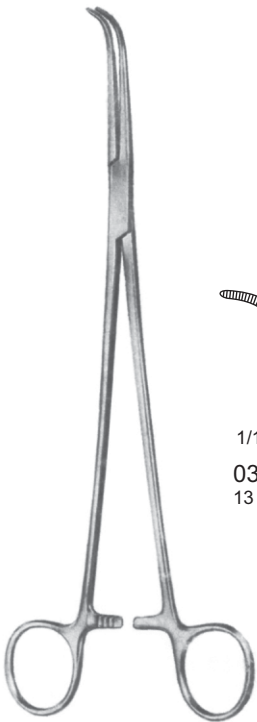

Gemini
03-039-18 - 03-039-28

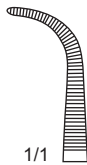

03-039-13
13 cm / 5"

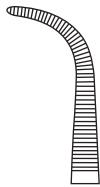

03-039-16
16 cm / 6¼"

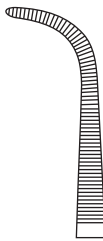

03-039-18
18 cm / 7"

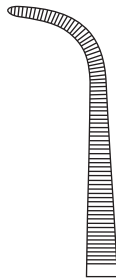

03-039-20
20 cm / 8"

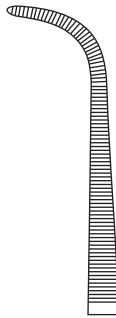

03-039-23
23 cm / 9"



03-039-25
25 cm / 10"

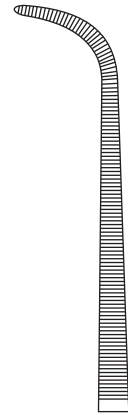

03-039-28
28 cm / 11"





Mixer
03-040-22 - 03-042-28

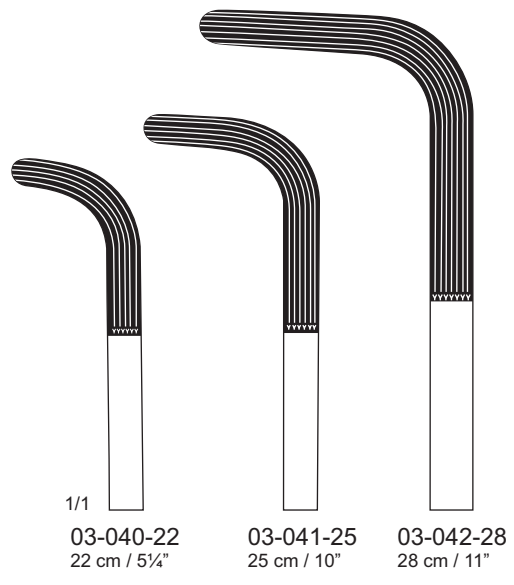

Lahey
03-043-19 - 03-044-23

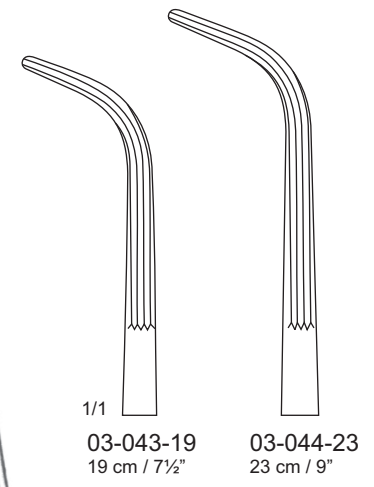

Heaney
03-045-19 - 03-046-23

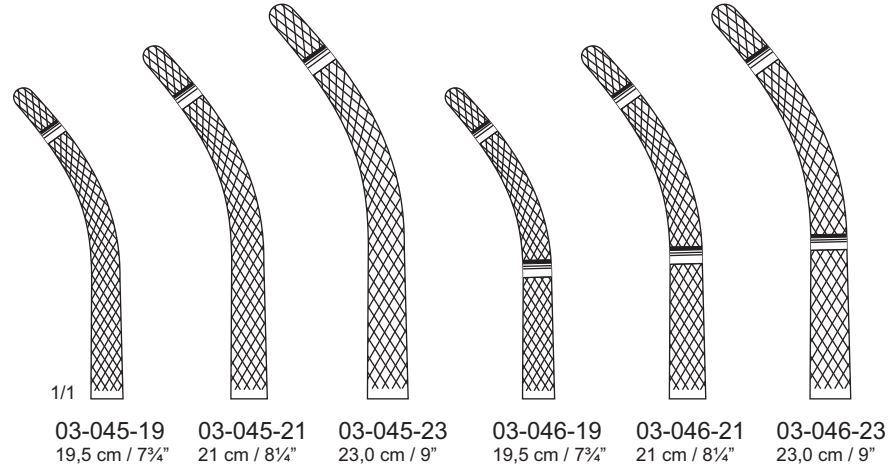

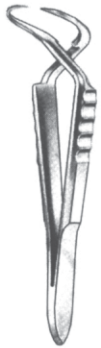

Jones
03-047-05 5 cm / 2"
03-047-09 9 cm / 3½"



Backhaus
03-048-08 8 cm / 3¼"
03-048-09 9 cm / 3½"
03-048-11 11 cm / 4½"
03-048-13 13 cm / 5"
03-048-15 15 cm / 6"



Bernhard
03-049-16
16,5 cm / 6½"

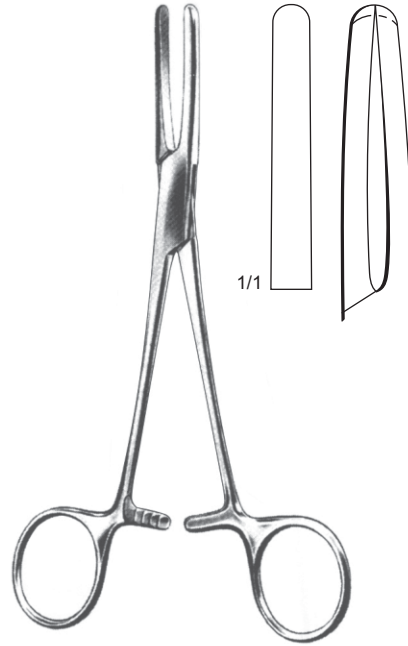

Tube Clamp
03-050-16
16,5 cm / 6½"



Standard
03-051-15 - 03-051-20



03-051-15
15 cm / 6"



03-051-18
18 cm / 7"

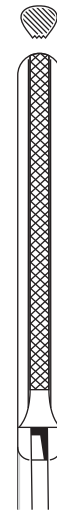

03-051-20
20 cm / 8"



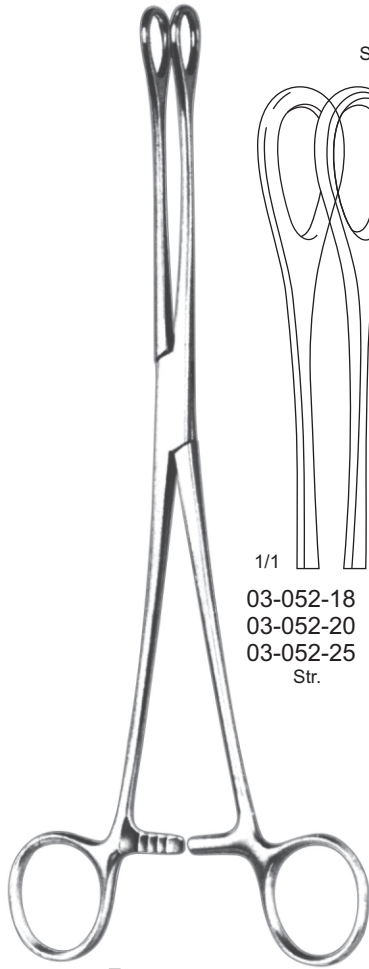

Foerster
03-052-18 - 03-055-25

SMOOTH

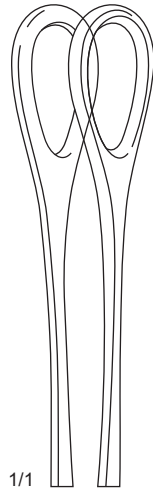

1/1
03-052-18 18 cm / 7"
03-052-20 20 cm / 8"
03-052-25 25 cm / 10"
Str.

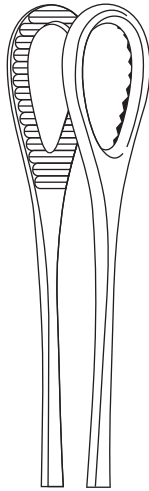

03-053-18 18 cm / 7"
03-053-20 20 cm / 8"
03-053-25 25 cm / 10"
Str.

SMOOTH

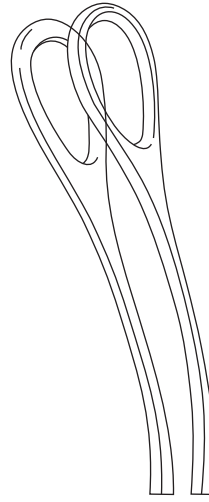

03-054-18 18 cm / 7"
03-054-20 20 cm / 8"
03-054-25 25 cm / 10"
Cvd.

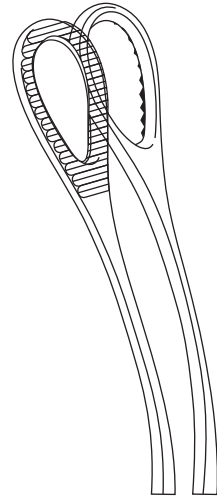

03-055-18 18 cm / 7"
03-055-20 20 cm / 8"
03-055-25 25 cm / 10"
Cvd.



Staude-Moore
03-056-17
17 cm / 6 3/4"



Rampley
03-057-25
25 cm / 10"



1/1

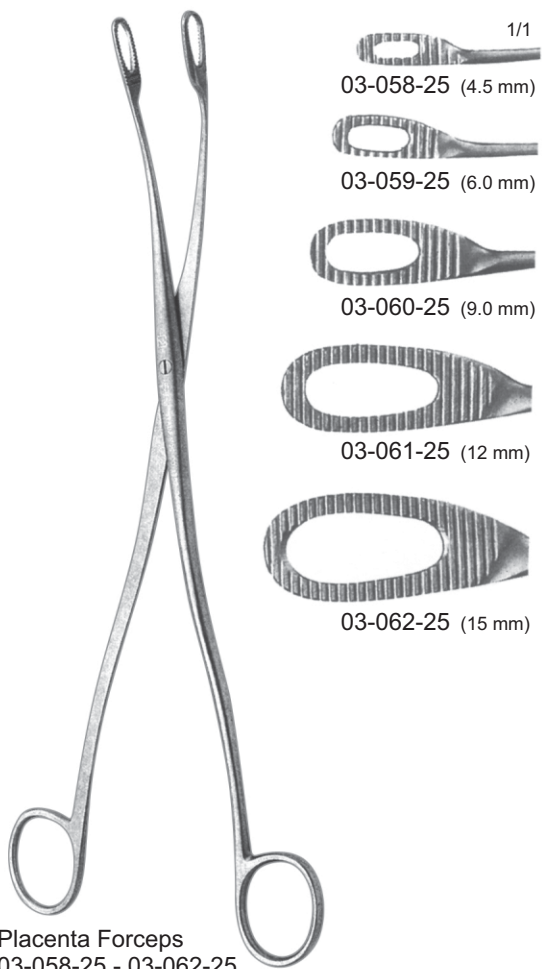

Placenta Forceps
03-058-25 - 03-062-25
25 cm / 10"

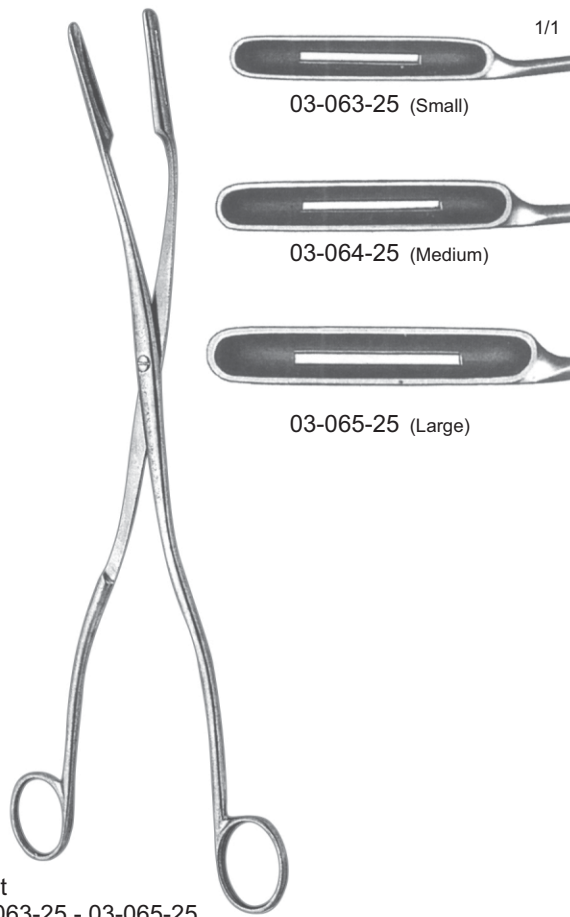

Hirst
03-063-25 - 03-065-25
25 cm / 10"

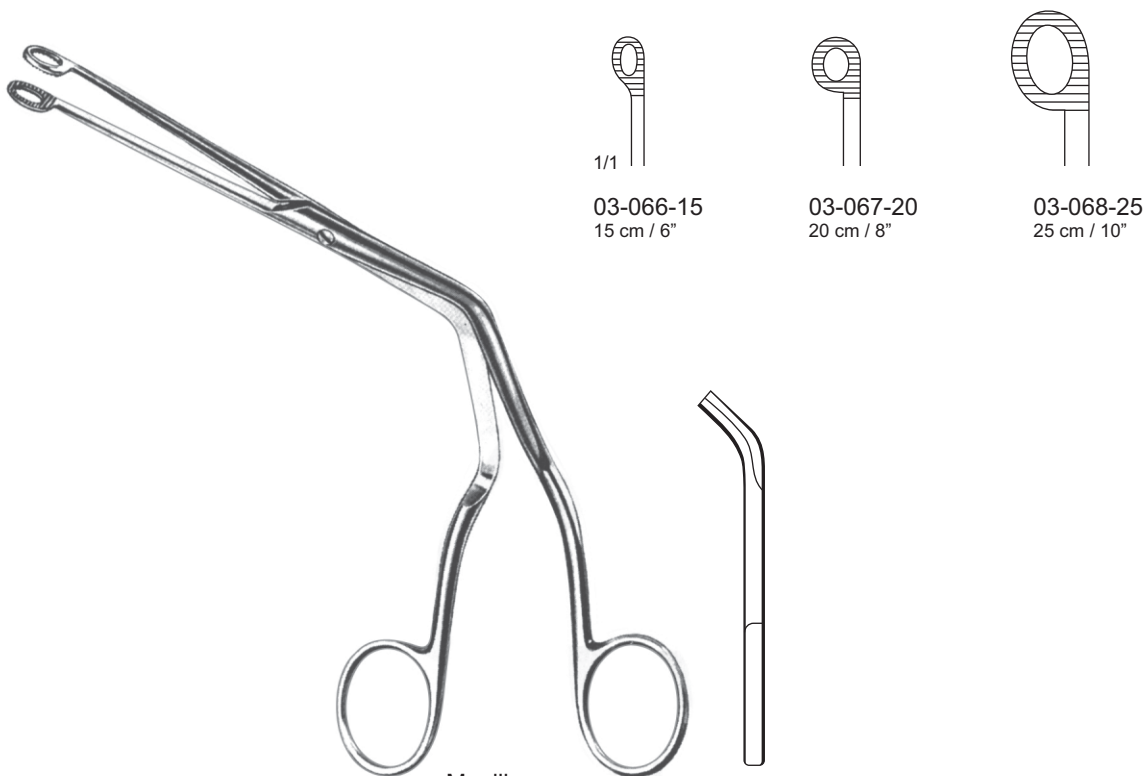

Magill
03-066-15 - 03-068-25



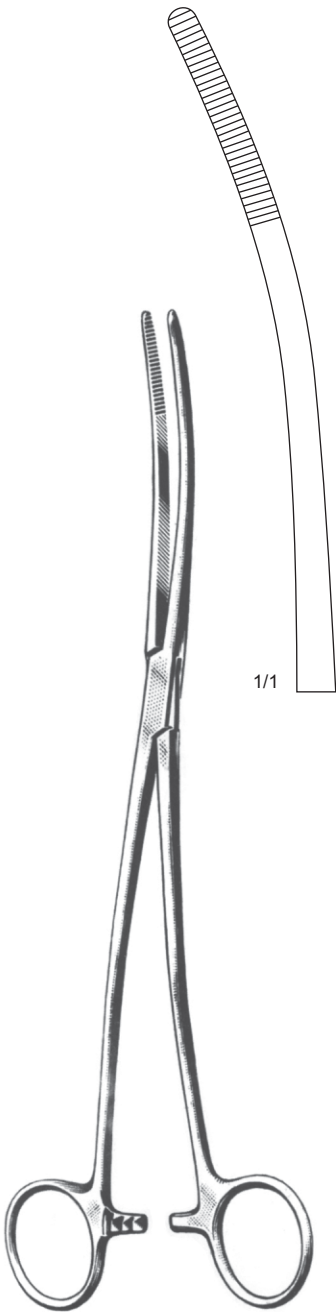

Bozemann
03-069-26
26 cm / 10¼"

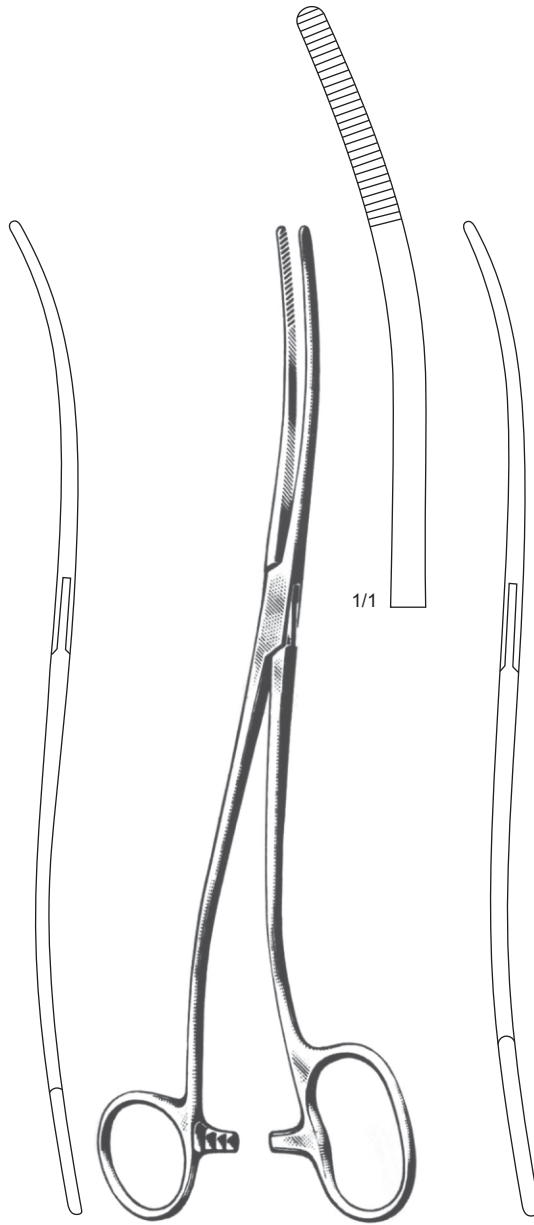

Bozemann-Douglas
03-070-26
26 cm / 10¼"

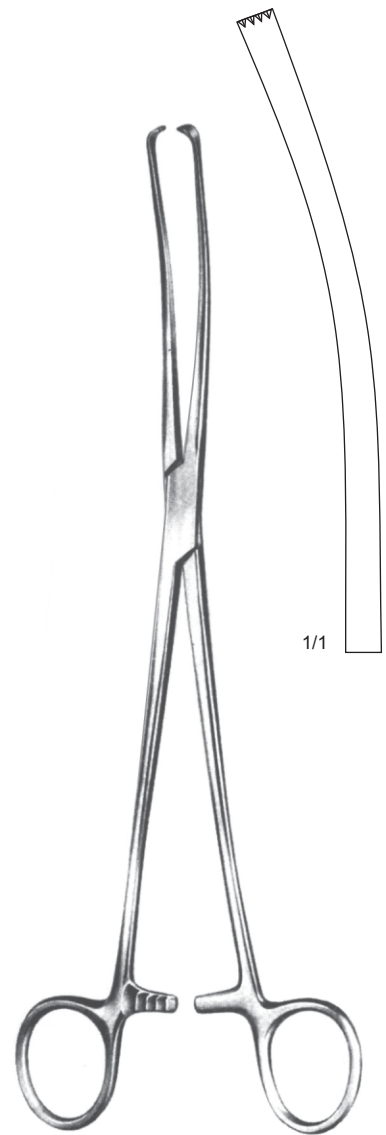

Lowa
03-071-26
26 cm / 10¼"



Pozzi
03-072-26
25,5 cm / 10¼"



Braun
03-073-25
25 cm / 10"



Schroeder
03-074-25
25 cm / 10"

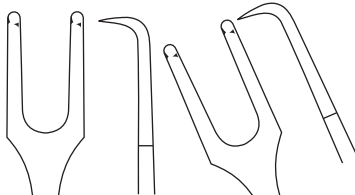

1/1
03-075-25

1/1
03-076-25



Schroeder 2x2 Teeth
03-075-25 - 03-076-24
24 cm / 9½"



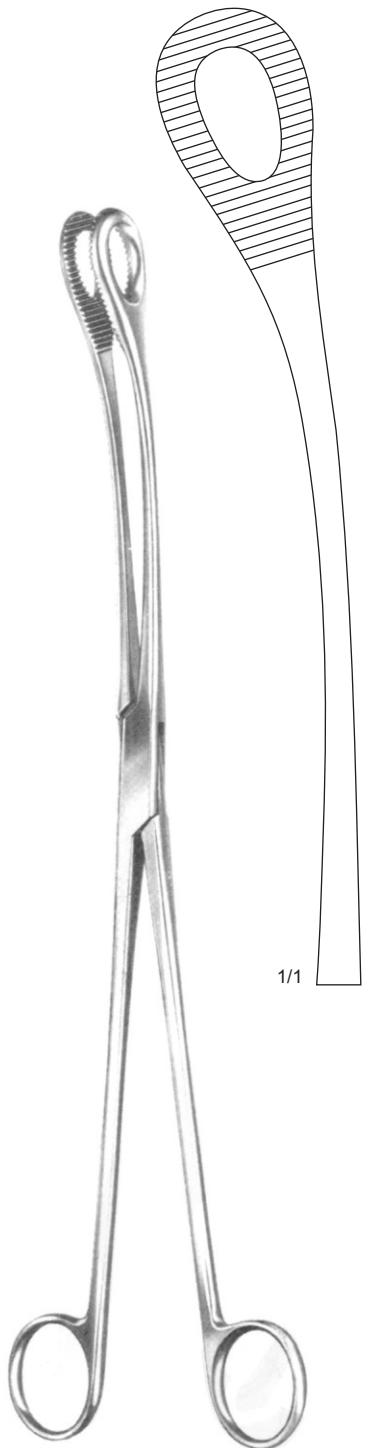

Kelly
03-077-32
32 cm / 12½"

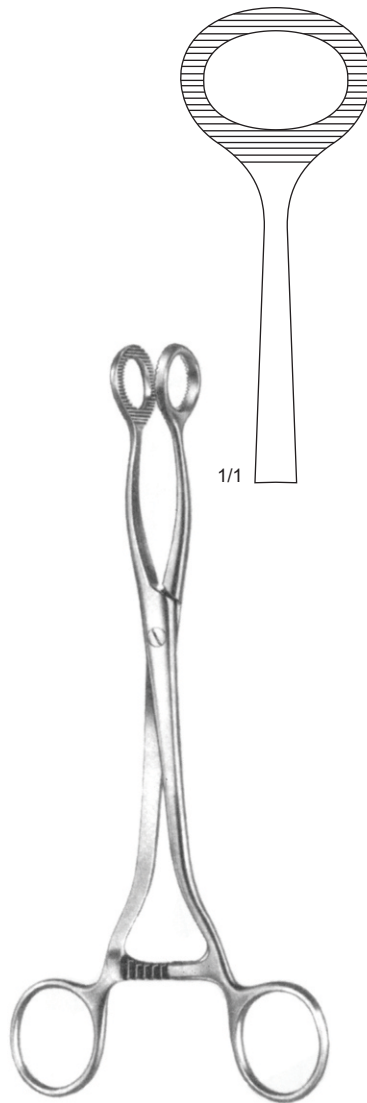

Doyen
03-078-20
20 cm / 8"

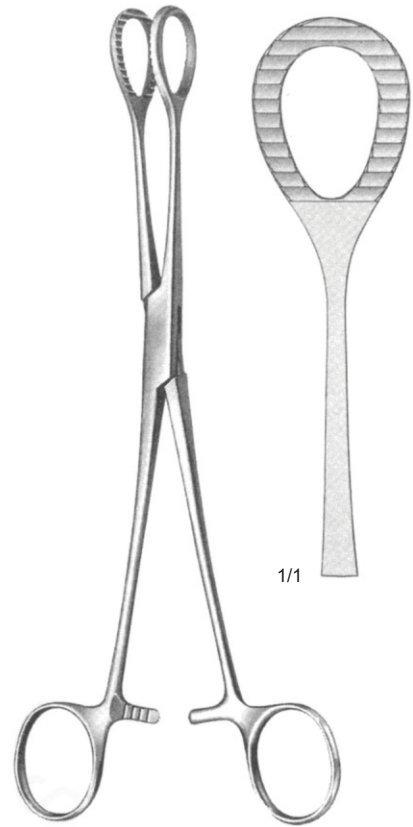

Heywood
03-079-20
20 cm / 8"

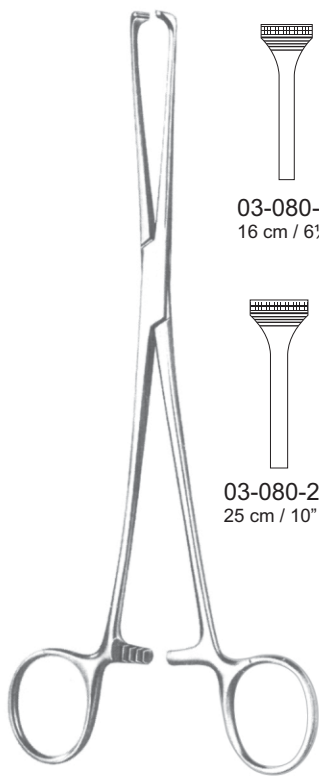

03-080-16
16 cm / 6 1/4"

03-080-20
20 cm / 8 1/4"

03-080-25
25 cm / 10"

03-080-30
30 cm / 12"

Allis-DeBakey
03-080-16 - 03-080-30

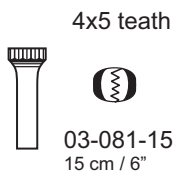

4x5 teeth

03-081-15
15 cm / 6"

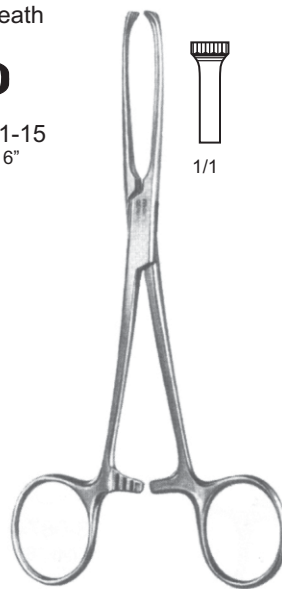

5x6 teeth

03-082-15
15 cm / 6"

03-082-19
19 cm / 7 1/2"

03-082-25
25 cm / 10"

Allis
03-081-15 - 03-082-25

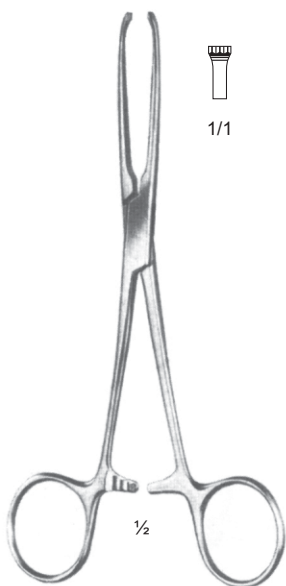

1/1

1/2

Judd-Allis
03-083-15 15 cm / 6"
03-083-19 19 cm / 7 1/2"

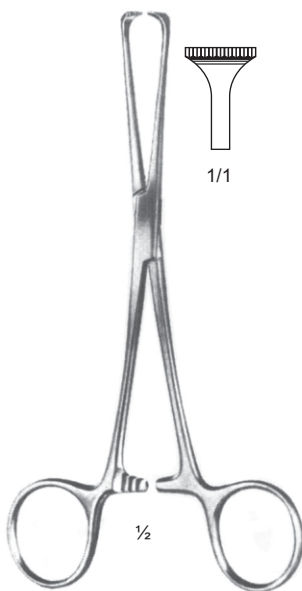

1/1

1/2

Allis-Adair
03-084-15
15 cm / 6"



1/1

1/1

1/2

Thomas-Allis
03-085-20
20 cm / 8"

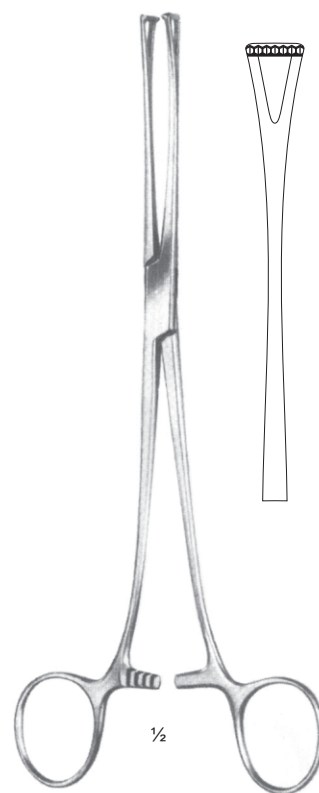

1/2

Lockwood
03-086-20
20 cm / 8"





Babcock
03-087-16 - 03-087-24

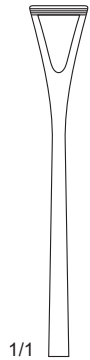

1/1
03-087-16
16 cm / 6¼"

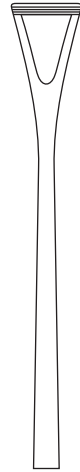

03-087-18
18 cm / 7"

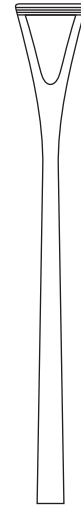

03-087-20
20 cm / 8"

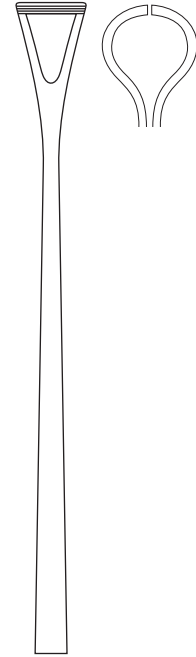

03-087-24
24 cm / 9½"

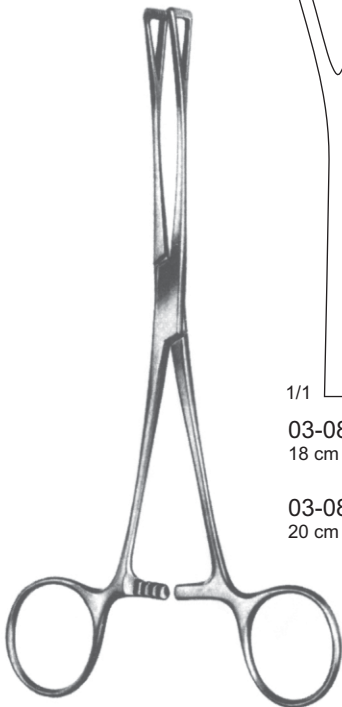

Duval
03-088-18 - 03-089-23

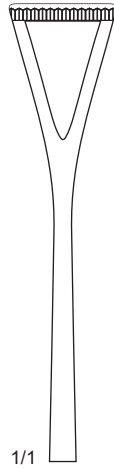

1/1
03-088-18
18 cm / 7"

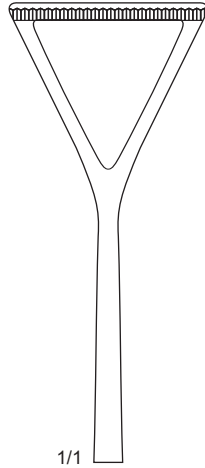

1/1
03-089-20
20 cm / 9"

03-088-20
20 cm / 8"

03-089-23
23 cm / 9"

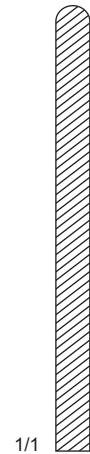

1/1
03-090-18

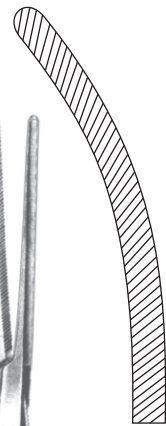

03-091-18

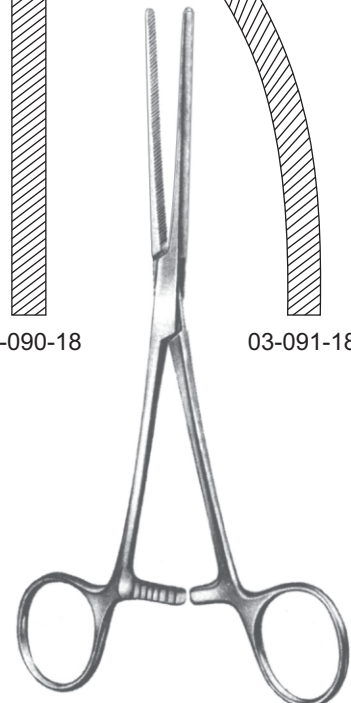

Baby-Doyen
03-090-18 - 03-091-18
18 cm / 7"

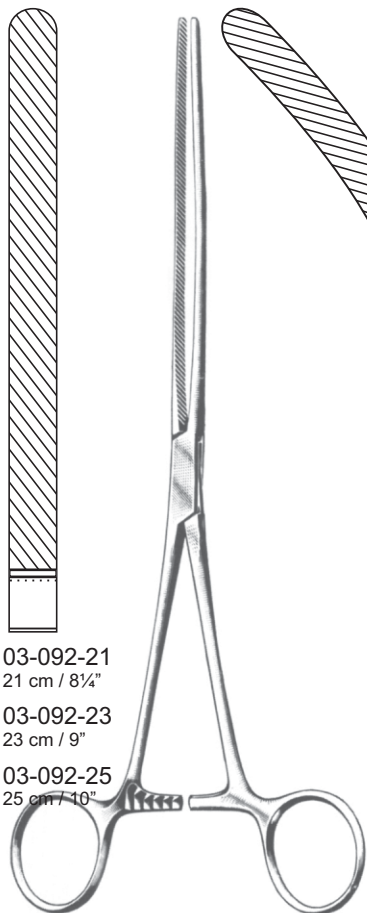

03-092-21
21 cm / 8 1/4"
03-092-23
23 cm / 9"
03-092-25
25 cm / 10"

Doyen
03-092-21 - 03-093-23

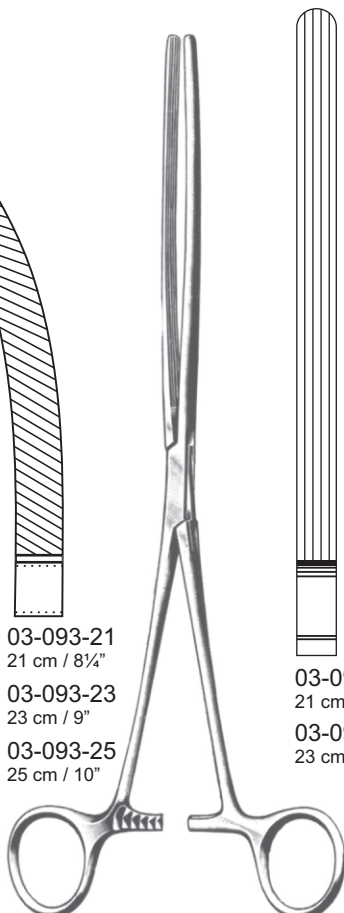

03-093-21
21 cm / 8 1/4"
03-093-23
23 cm / 9"
03-093-25
25 cm / 10"

Mayo-Robson
03-094-21 - 03-095-23

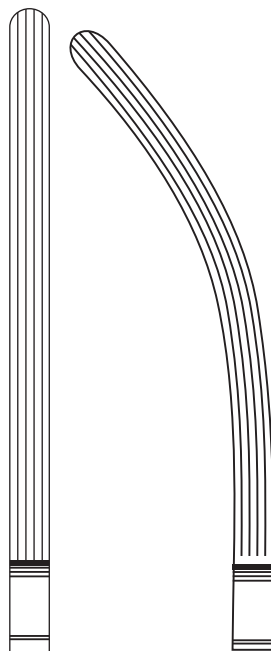

03-094-21
21 cm / 8 1/4"
03-094-23
23 cm / 9"

03-095-21
21 cm / 8 1/4"
03-095-23
23 cm / 9"

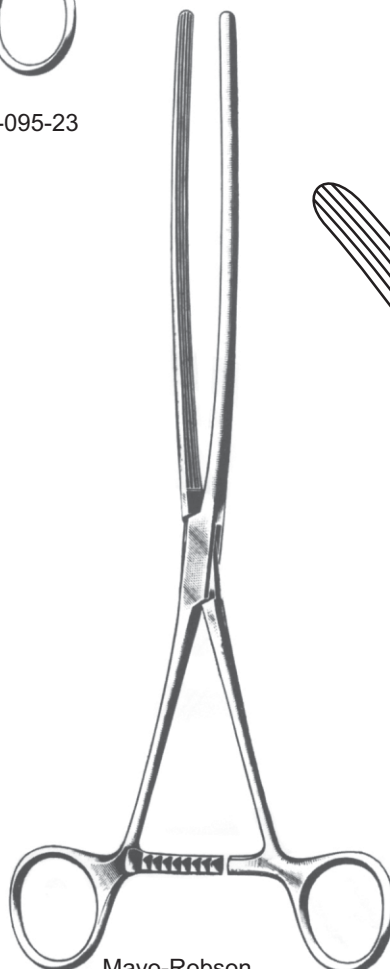

1/1
03-096-25

Mayo-Robson
03-096-25 - 03-097-25
25 cm / 10"

03-097-25



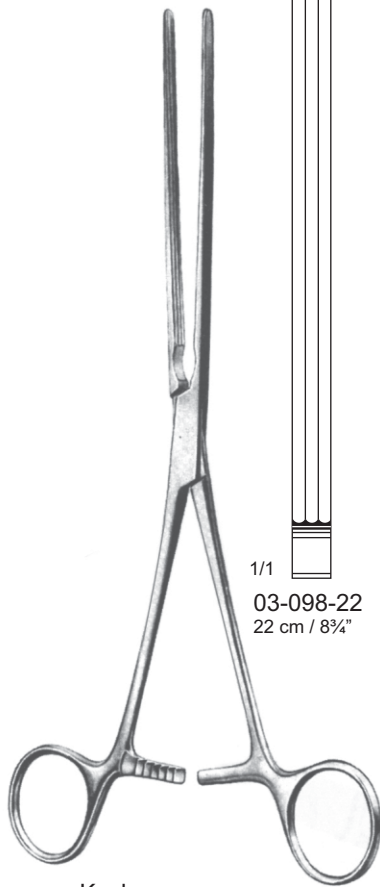

Kocher
03-098-22 - 03-098-28

1/1

03-098-22
22 cm / 8³/₄"

03-098-25
25 cm / 10"

03-098-28
28 cm / 11"

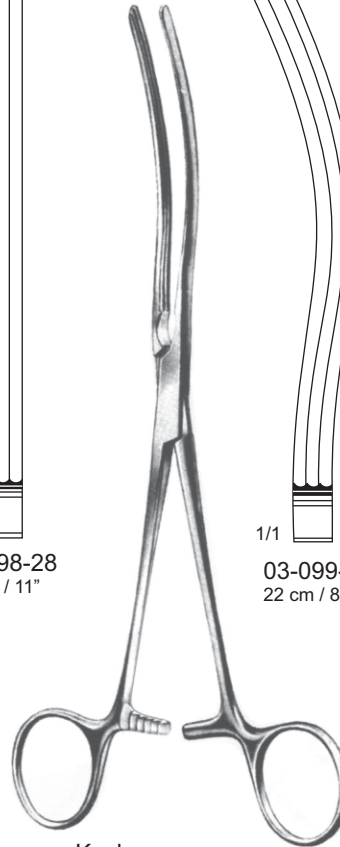

Kocher
03-099-22 - 03-099-28

1/1

03-099-22
22 cm / 8³/₄"

03-099-25
25 cm / 10"

03-099-28
28 cm / 11"

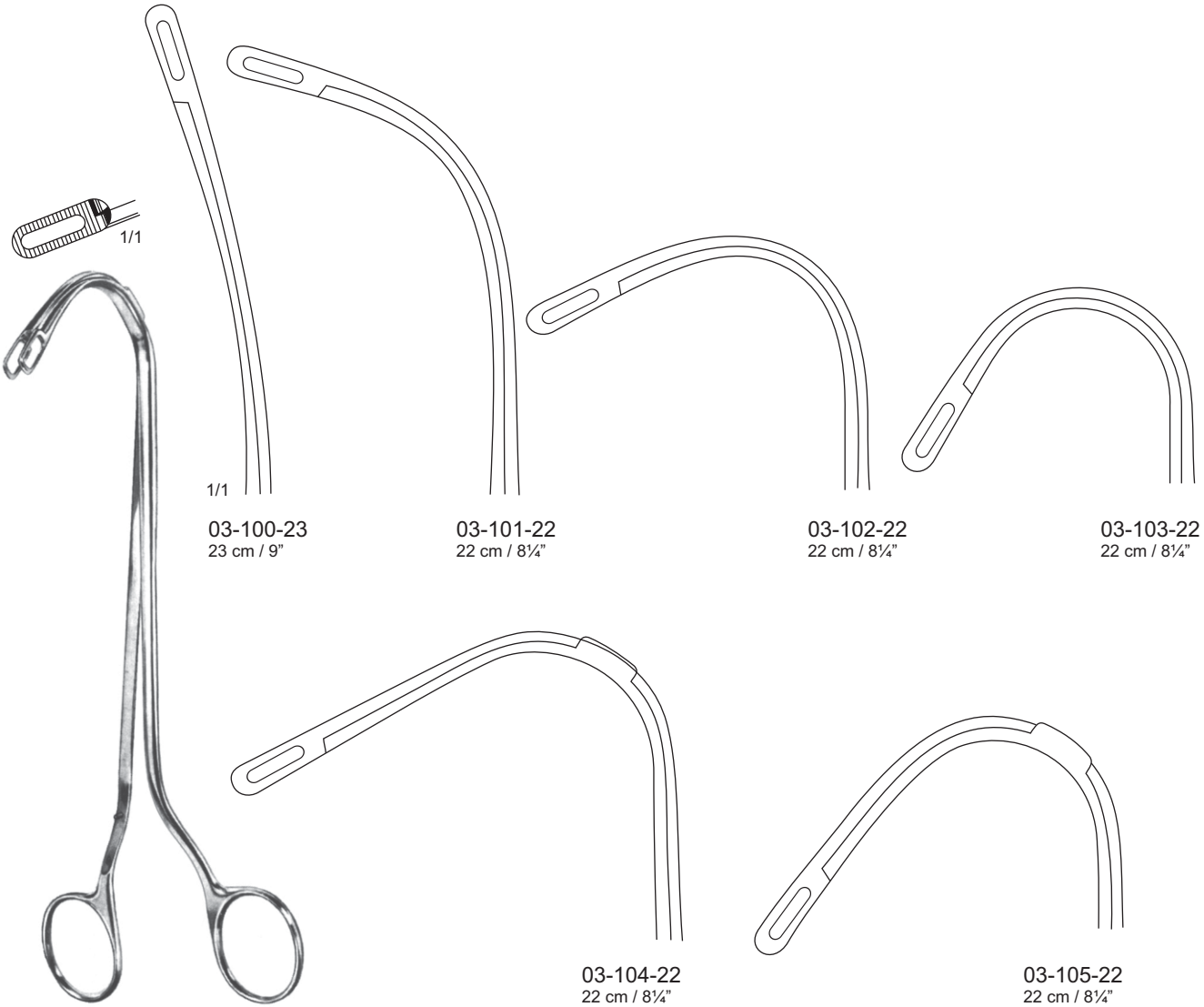
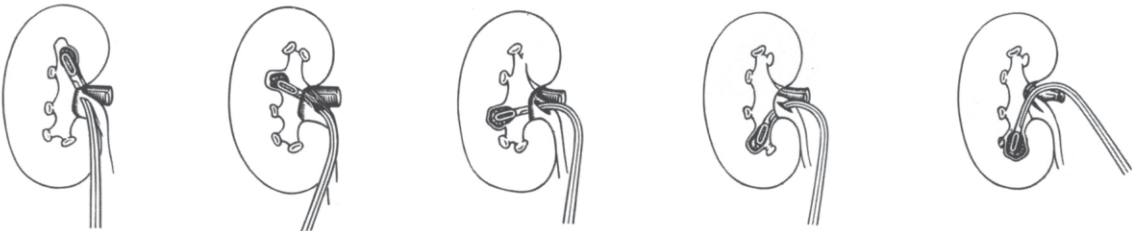

03-100-23
23 cm / 9"

03-101-22
22 cm / 8 1/4"

03-102-22
22 cm / 8 1/4"

03-103-22
22 cm / 8 1/4"

03-104-22
22 cm / 8 1/4"

03-105-22
22 cm / 8 1/4"

Randall
03-100-23 - 03-105-19



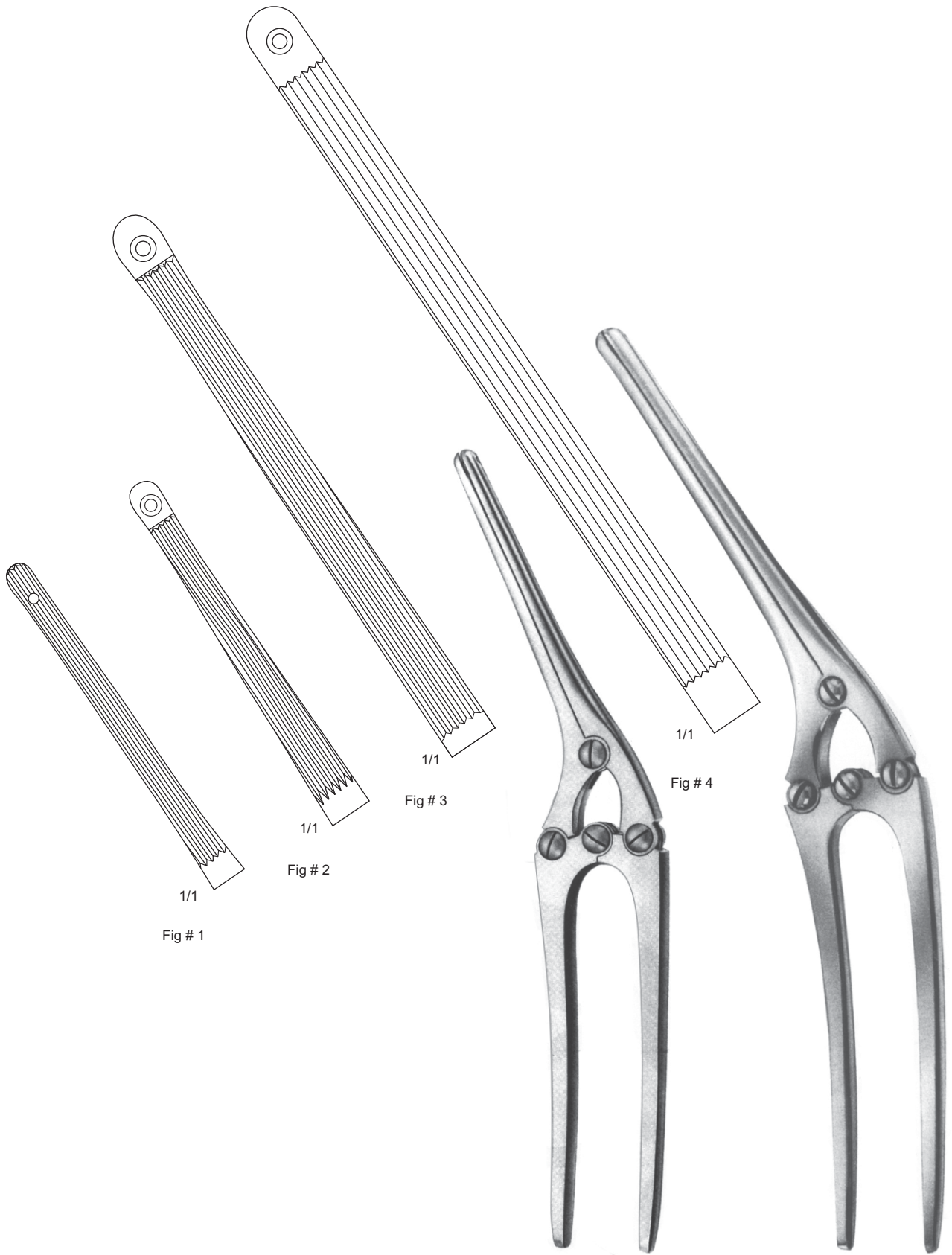

Fig # 1

Fig # 2

Fig # 3

Fig # 4

Payr Intestinal Clamp

Payr Pylorus Intestinal Clamp

- Fig # 1 03-106-18 18 cm / 7"
- Fig # 2 03-106-20 20 cm / 8"
- Fig # 3 03-106-28 28 cm / 10¾"

- Fig # 4 03-107-32 32 cm / 12½"



DeBakey
03-108-05
05 cm / 2"



DeBakey
03-109-05
05 cm / 2"



Glover
03-110-06
06 cm / 2½"



DeBakey
03-111-06
06 cm / 2½"

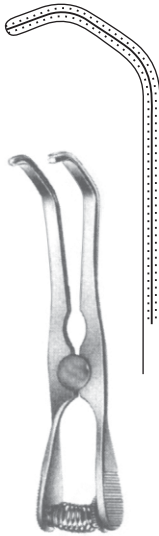

DeBakey
03-112-10
10 cm / 4"

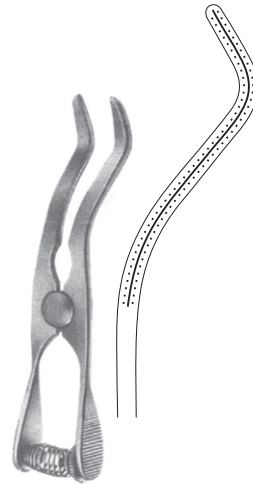

DeBakey
03-112-09
09 cm / 3½"



Glover
03-113-06 06 cm / 2½"
03-114-09 09 cm / 3½"
03-115-11 11 cm / 4¾"



Cooley
03-116-06 06 cm / 3¼"
03-117-08 08 cm / 3½"
03-118-13 13 cm / 5½"



DeBakey
03-119-08 08 cm / 3¼"
03-120-09 08 cm / 3½"
03-121-10 10 cm / 5¾"
03-122-13 13 cm / 4½"



DeBakey
03-123-08 08 cm / 3¼"
03-124-09 08 cm / 3½"
03-125-10 10 cm / 3¾"
03-126-11 11 cm / 4½"





Johns-Hopkins
03-134-23
23 cm / 9³/₄"



1/1
Bulldog Clamp
03-127-05
4.5 cm / 1³/₄"



1/1
Bulldog Clamp
03-128-05
4.5 cm / 1³/₄"



1/1
Bulldog Clamp
03-129-04
3.5 cm / 1¹/₂"



1/1
Bulldog Clamp
03-129-05
3.5 cm / 1¹/₂"



1/1
Dieffenbach
03-130-05
5.8 cm / 2"



1/1
Dieffenbach
03-131-05
5.8 cm / 2"



1/1
Dieffenbach
03-132-05
4.0 cm / 1¹/₂"



1/1
Dieffenbach
03-133-04
5.0 cm / 2"

- Johns-Hopkins**
- 03-135-04 04 cm / 1¹/₂"
- 03-135-05 05 cm / 2"
- 03-135-06 06 cm / 2"
- 03-135-07 07 cm / 2¹/₂"
- 03-135-08 08 cm / 2³/₄"
- 03-135-09 09 cm / 3"
- 03-135-10 10 cm / 3¹/₂"



1/1
DeBakey-Hess
03-136-05
05 cm / 2"



1/1
DeBakey-Hess
03-137-05
4.5 cm / 1³/₄"

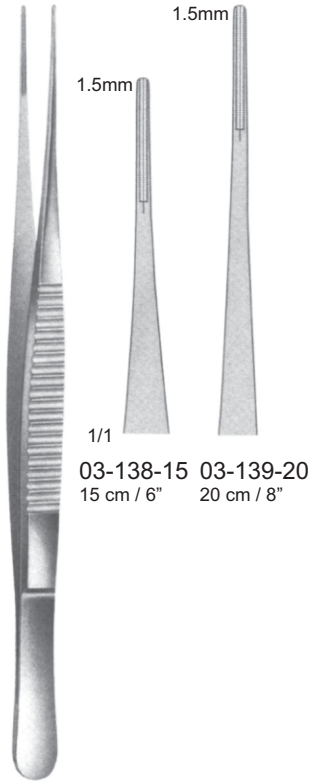

DeBakey
03-138-15 - 03-139-20

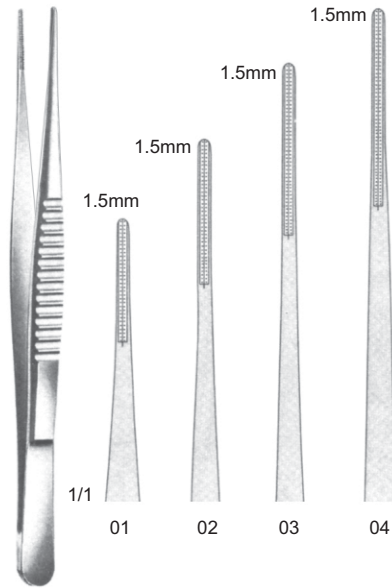

DeBakey
03-140-15 15 cm / 6" (01)
03-141-20 20 cm / 8" (02)
03-142-24 24 cm / 9½" (03)
03-143-30 30 cm / 12" (04)

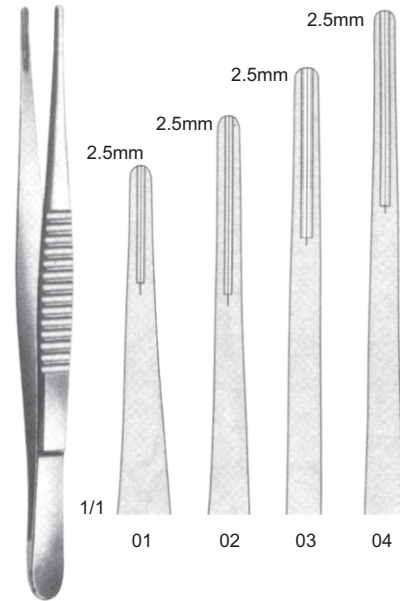

DeBakey
03-144-15 15 cm / 6" (01)
03-145-20 20 cm / 8" (02)
03-146-24 24 cm / 9½" (03)
03-147-30 30 cm / 12" (04)

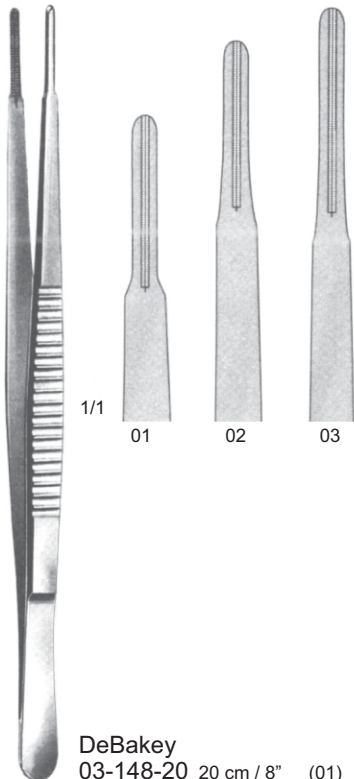

DeBakey
03-148-20 20 cm / 8" (01)
03-149-24 24 cm / 9½" (02)
03-150-30 30 cm / 12" (03)

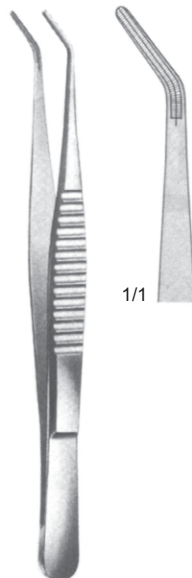

DeBakey
03-151-15 15 cm / 6"

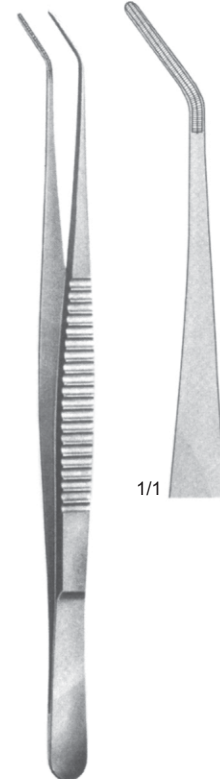

DeBakey
03-152-20 20 cm / 8"





Bainbridge
03-153-15 - 03-154-18

1/1
03-153-15
15 cm / 6"

1/1
03-154-18
18 cm / 7"



DeBakey
03-155-16
16,5 cm / 6½"



DeBakey
03-156-20 20.5 cm / 8" (01)
03-157-22 22.5 cm / 9" (02)
03-158-24 24.5 cm / 9¾" (03)



DeBakey
03-159-20 20.5 cm / 8" (01)
03-160-22 22.5 cm / 9" (02)
03-161-24 24.5 cm / 9¾" (03)

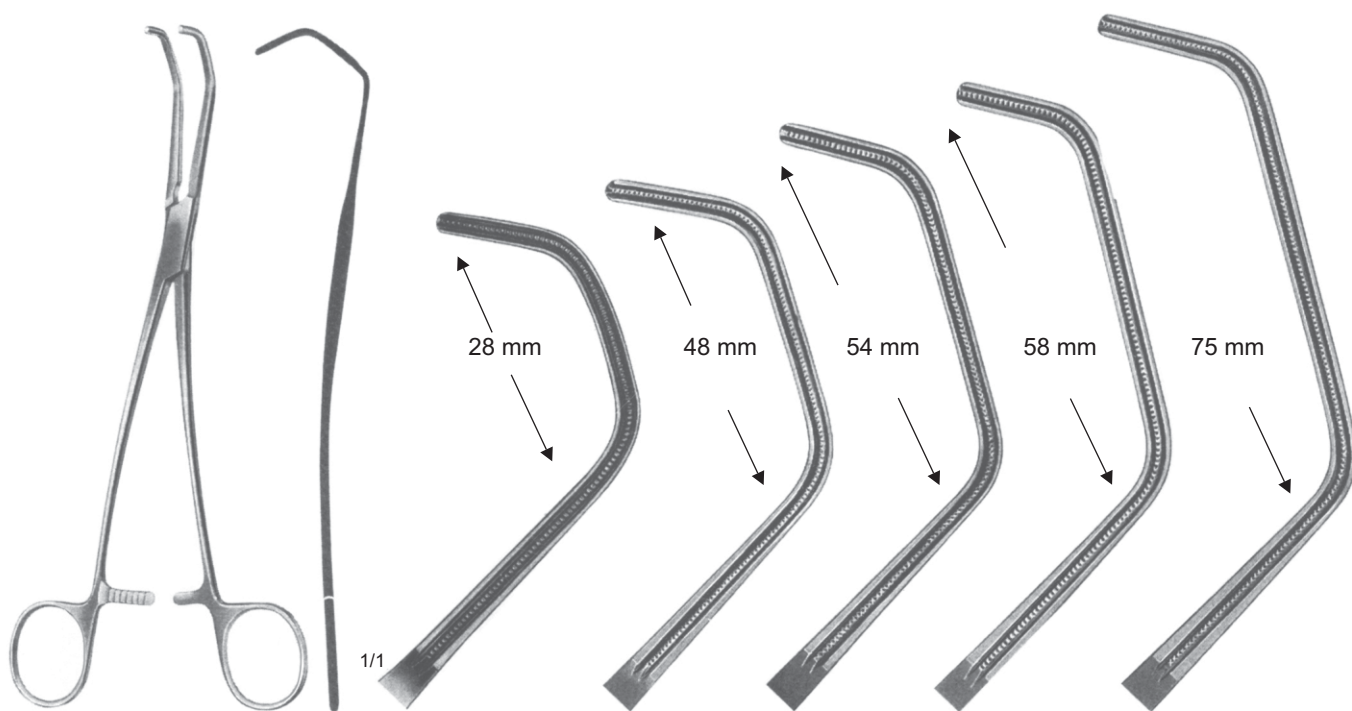

DeBakey
03-162-18 - 03-166-28

03-162-18
18 cm / 7"

03-163-26
26 cm / 10¼"

03-164-27
27,5 cm / 10¾"

03-165-27
27,5 cm / 10¾"

03-166-28
28 cm / 11"



DeBakey-Satinsky
03-167-28 - 03-169-24

03-167-23
23,5 cm / 9¼"

03-168-24
24 cm / 9½"

03-169-24
24,5 cm / 9¾"

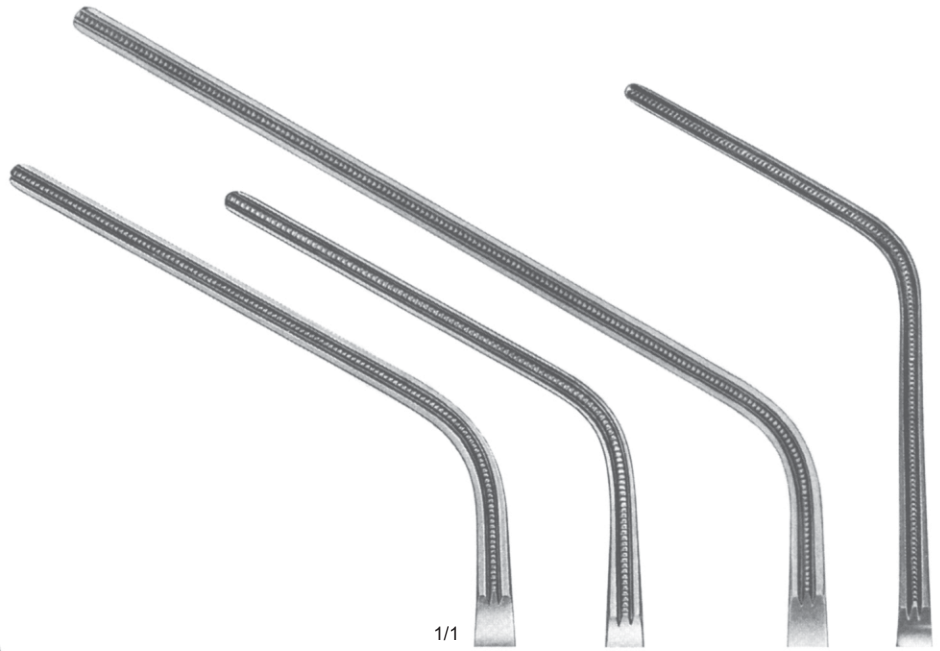

1/1

03-170-23
23 cm / 9"

03-171-28
28 cm / 11"

03-172-30
30,5 cm / 12"

03-173-24
24 cm / 9½"

DeBakey
03-170-23 - 03-173-24

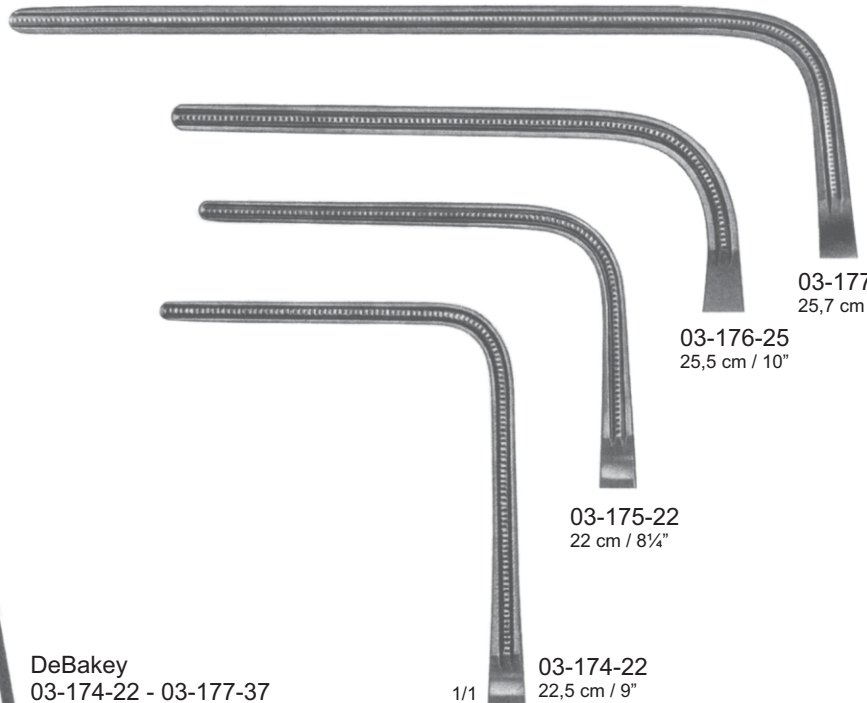

03-177-25
25,7 cm / 10¾"

03-176-25
25,5 cm / 10"

03-175-22
22 cm / 8¾"

03-174-22
22,5 cm / 9"

1/1

DeBakey
03-174-22 - 03-177-37



Fixing
03-178-14
14 cm / 5½"



Dissecting
03-178-13
13 cm / 5"

Vasectomy Set
03-178-00
Set of 2

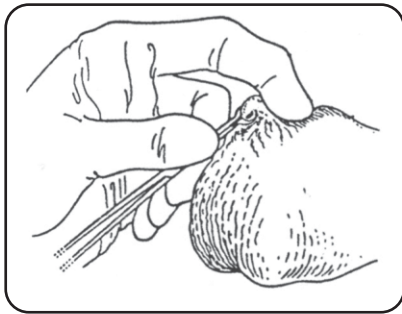

Fig. 1 Fixation of the vas

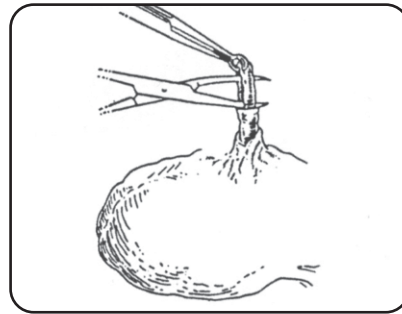

Fig. 4 Catching and freeing the vas deferens

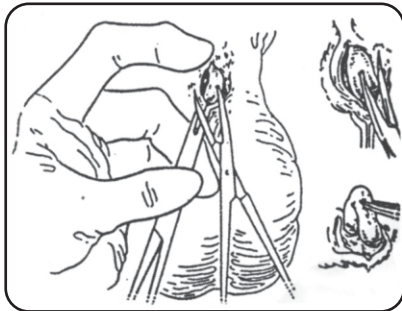

Fig. 2 Separating the Scrotal wall and the vas deferens

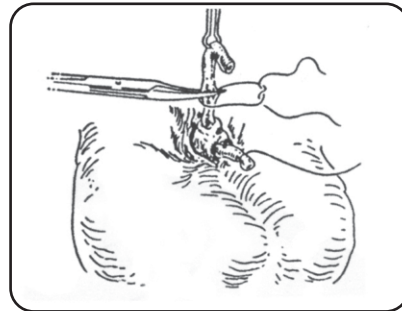

Fig. 5 Ligation of the vas deferens

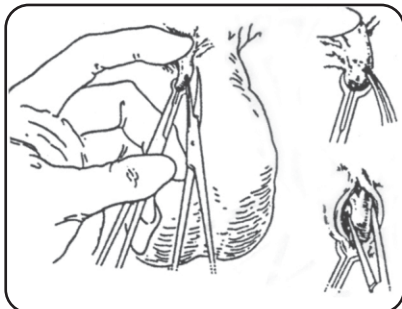

Fig. 2 Elevation of the vas deferens

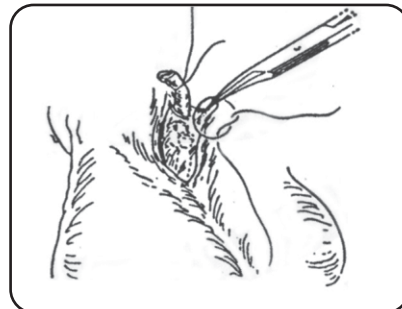
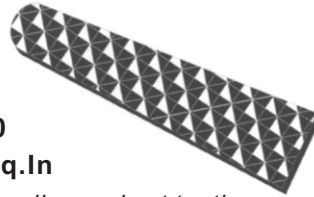

Fig. 8 Embedding of the Epididymal end of vas deferens





A GUIDE TO INSERT SELECTION



**2500
Teeth/Sq.In**

*Large size diamond cut teeth
for use with heavy needles and
suture (4/0 and larger)*

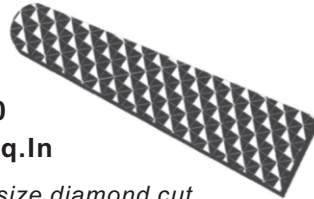

**4000
Teeth/Sq.In**

*Medium size diamond cut
teeth for use with fine
suture (3/0 to 6/0)*

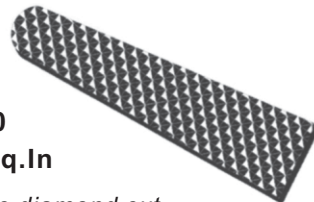

**7000
Teeth/Sq.In**

*Extra-fine diamond cut
teeth for use with only delicate
suture (5/0 to 8/0)*

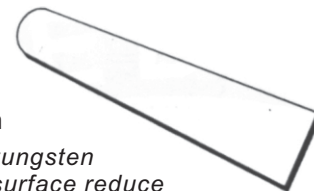

Smooth

*Smooth tungsten
carbide surface reduce
damage to delicate needles
and sutures (6/0 and finer).*



Order
Please order your required teeth size in addition to the
regular catalogue no of our product.
Example: 1 X TC needle holder 0103321 teeth 4000